

UGP-20231QW

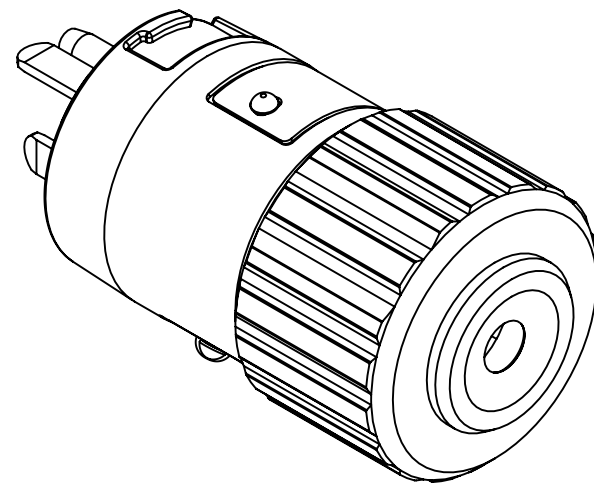
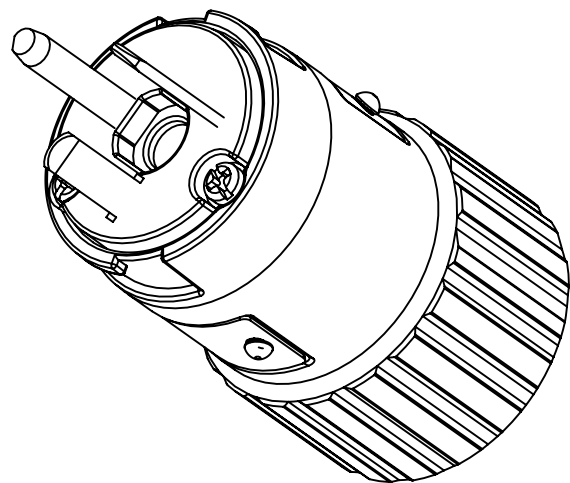
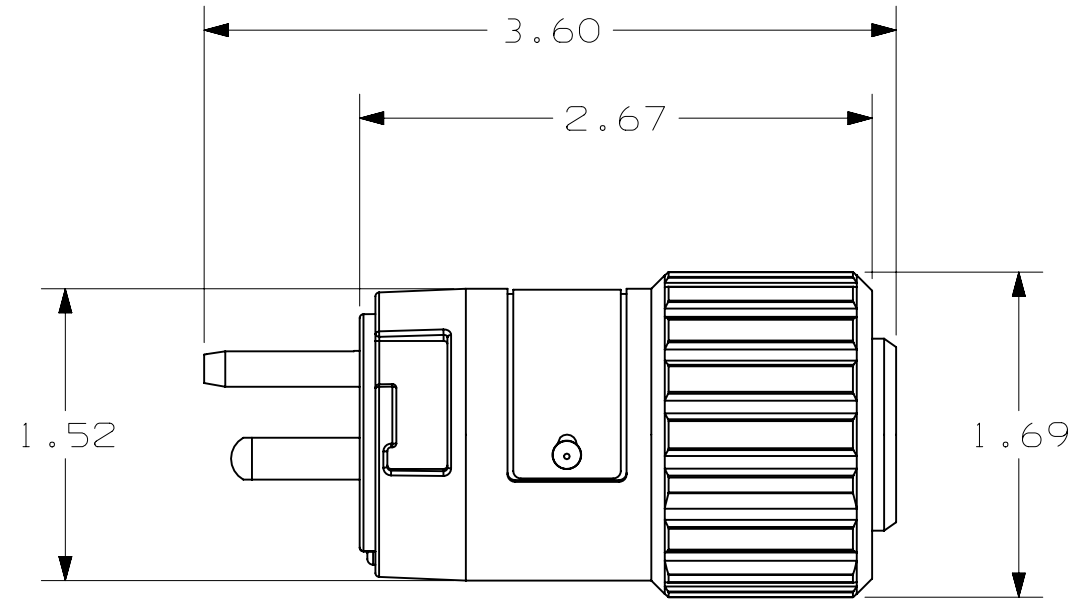

THIS IS A COMPUTER GENERATED DRAWING. DO NOT ALTER. CHANGES ALLOWED ONLY TO COMPUTER MODEL.

DO NOT SCALE THIS DRAWING

TOLERANCES
 FRACTIONAL DIMENSIONS $\pm 1/32"$
 2 PLACE DECIMAL DIMENSIONS $\pm .01$
 3 PLACE DECIMAL DIMENSIONS $\pm .005$
 ANGULAR DIMENSIONS $\pm .5^\circ$

P/N



KILLARK

THIS DOCUMENT IS THE PROPERTY OF KILLARK. IT IS LOANED TO YOU AND MUST NOT BE USED IN ANY WAY DETRIMENTAL TO THE INTEREST OF KILLARK.

DESCRIPTION:

UGP-20231QW OUTLINE

G	N	U
F	M	T
E	L	S
D	K	R
C	J	Q
B	I	P
A	H	O
LET CHG. NOT. NO.	LET CHG. NOT. NO.	LET CHG. NOT. NO.

DR. BY:	REL PROD:
CK. BY:	REL TOOL:
SCALE:	REL DES:
MATERIAL:	
PROJECT NO:	SHEET OF