

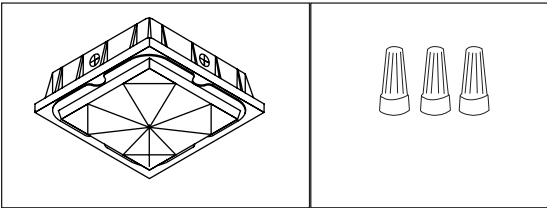

### WARNING

- Risk of fire or electric shock. LED installation requires knowledge of luminaires electrical systems. Review the diagrams thoroughly before beginning. All electrical connections must be in accordance with local codes, ordinances, and the National Electric Code. If not qualified, do not attempt installation. Contact a qualified licensed electrician.
- Before installation, disconnect the power by turning off the circuit breaker or by removing the appropriate fuse at the fuse box. Using the light switch to turn power off is not sufficient to prevent electrical shock.
- To prevent wiring damage or abrasion, do not expose wiring to edges of sheet metal or other sharp objects
- All parts must be used as indicated in the instructions.
- The use of accessory equipment not recommended by the manufacturer may cause an unsafe condition.
- To maintain Wet Location Rating, ONLY use UL approved wet location junction boxes and conduit.
- Operating temperature: -40°C to 40°C

## What's In The Box



One (1) OUC

Three (3) Wire Nuts

## Tools Needed

A screwdriver, drill, a pair of wire strippers, and 4 fasteners appropriate for the mounting surface will be needed to install the Vela.



*Make sure all power is turned off before beginning installation*

- 1** Carefully unpack fixture from packaging and inspect for any damage caused in shipping.

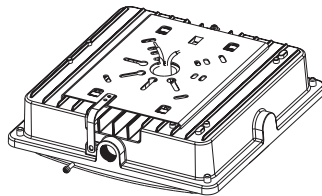

- 2** Turn off power using appropriate switch/breaker.

- 3** Locate desired positioning for the fixture on the mounting surface or junction box.

## Mounting to j-box

- 4a** Loosen the mounting plate screw on side of housing and slide luminaire out.

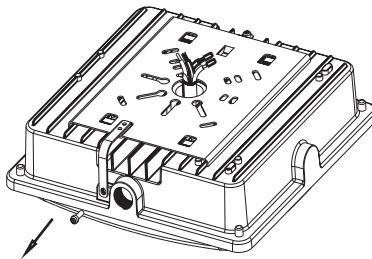

- 4b** Fasten the mounting plate onto the ceiling/junction box and pull building wires through hole.

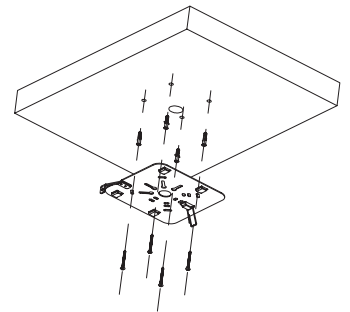

- 4c** Fasten luminaire to the hinge clip and let hang. Connect the wires. Cap the dimming leads if not used.

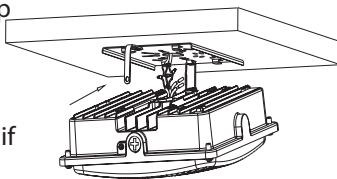

- 4d** Slide luminaire into the mounting plate clips and fasten the mounting plate screw.

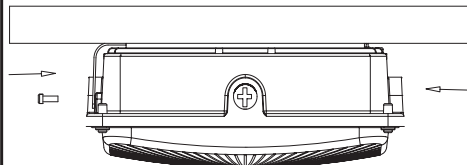

- 4e** Check to ensure luminaire is securely fastened

4f Connect wiring as shown in Wiring Diagram.  
Cap off dimming wires if not used.

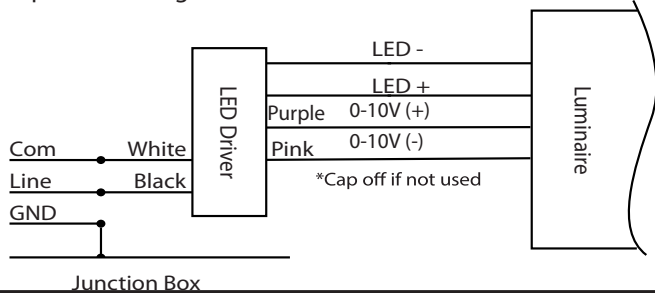

4g The Product features selectable CCT and Power Select. Select desired CCT & Power. Reinstall cap.

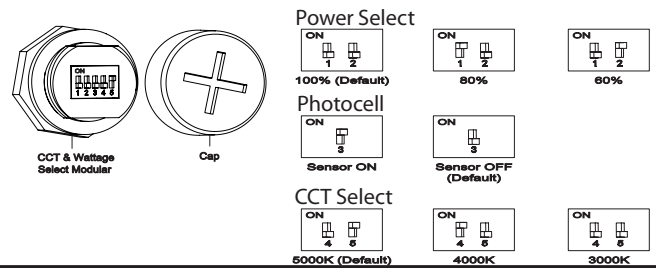

### Mounting with a pendant

5a Remove mounting plate by loosening the screw.  
(NOT NEEDED FOR PENDANT MOUNT)

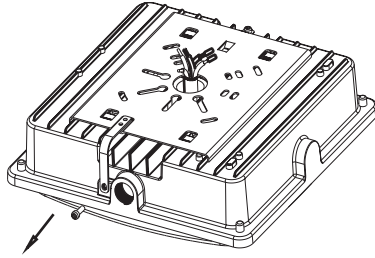

5b Remove plug and twist in pendant conduit (3/4" SIZE OF THREAD AND HOLE) and follow wiring diagram

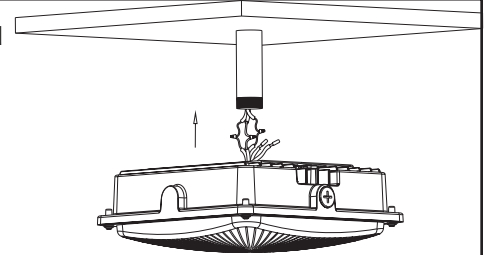

6 Check that fixture is firmly attached to mounting surface.

7 Turn power on (or energize fixture) and verify that the fixture is lit.

Subject to the exclusions below, each NICOR LED product, including the LED electronics and components of a property installed NICOR LED product, will be free from defect in materials and workmanship for a period of five (5) years from the original date of purchase. The product shall be considered defective only if 10% or more of the product's LED components fail. NICOR LED product warranty covers the following performance criteria: LED Light Output will be maintained above 70% of initial output; LED color temperature will not shift more than 200K in CCT; LED driver will operate within NICOR specifications; and the fixture finish, excluding natural aluminum or brass products, will not exhibit cracking, peeling, excessive fading, or corrosion during the warranty period. Exceptions apply as defined in NICOR's product specification sheets, which are incorporated by reference herein.

This limited warranty is provided to you, the purchaser of the product identified on Seller's invoice, as your exclusive remedy and applies only to NICOR products that have been purchased from an authorized NICOR Distributor; the product was new and in an unopened NICOR package at the time of installation; and the NICOR product was installed by a licensed electrician or under the supervision of a licensed electrician and used by consumers in the United States or Canada when accompanied with this warranty. This warranty extends only to the first consumer purchaser and is not transferable. A consumer wishing to invoke the terms of this limited warranty must first obtain a RGA number within 30 days of discovery of the defect, and return the product to NICOR for inspection. Once verified to be covered by this limited warranty, NICOR will, at its sole discretion, repair, replace, or refund the purchase price of any product that does not conform to this limited warranty. If NICOR, at its sole discretion, determines that the product should be repaired or replaced, this warranty is limited to the reasonable, customary, and necessary costs and expenses associated with the repair/replacement. This warranty requires that all repair/replacement estimates and costs, including but not limited to equipment rental (if any), and any other cost or expense to be incurred in the repair/replacement of the product, be approved in advance and in writing by NICOR. FAILURE TO OBTAIN NICOR'S ADVANCE WRITTEN APPROVAL OF ALL REPAIR/REPLACEMENT COSTS AND EXPENSES IN WRITING SHALL VOID THIS LIMITED WARRANTY.

**THIS LIMITED WARRANTY DOES NOT COVER THE FOLLOWING:**

- Defects or damages resulting from improper installation, operation, storage, misuse or abuse, accident, or neglect;
- Defects or damages resulting from improper service, testing, adjustment, installation, maintenance, alteration, connection to out-of-specification electrical service, corrosive or damp environments, or connection to incompatible equipment or devices (e.g., connecting non-dimmable lighting products to dimmers);
- Damage which occurs in transit;
- Power surges or overheating due to external conditions
- Acts of nature including but not limited to lightning strikes

ANY IMPLIED WARRANTIES, INCLUDING WITHOUT LIMITATION, THE IMPLIED WARRANTIES OF MERCHANTABILITY AND FITNESS FOR A PARTICULAR PURPOSE SHALL BE LIMITED TO THE DURATION OF THIS LIMITED WARRANTY, OTHERWISE THE REPAIR, REPLACEMENT, OR REFUND AS PROVIDED UNDER THIS EXPRESS LIMITED WARRANTY IS THE EXCLUSIVE REMEDY OF THE CONSUMER, AND IS PROVIDED IN LIEU OF ALL OTHER WARRANTIES, EXPRESS OR IMPLIED. IN NO EVENT SHALL NICOR BE LIABLE, WHETHER IN CONTRACT OR IN TORT (INCLUDING NEGLIGENCE) FOR DAMAGES IN EXCESS OF THE PURCHASE PRICE OF THE PRODUCT, OR FOR ANY INDIRECT, INCIDENTAL, SPECIAL OR CONSEQUENTIAL DAMAGES OF ANY KIND, OR LOSS OF REVENUE OR PROFITS, LOSS OF BUSINESS OR OTHER FINANCIAL LOSS ARISING OUT OF OR IN CONNECTION WITH THE ABILITY OR INABILITY TO USE THE PRODUCT TO THE FULL EXTENT THESE DAMAGES MAY BE DISCLAIMED BY LAW

This device complies with part 15 of the FCC Rules. Operation is subject to the following two conditions: (1) This device may not cause harmful interference, and (2) this device must accept any interference received, including interference that may cause undesired operation.

NOTE: This equipment has been tested and found to comply with the limits for a Class B digital device, pursuant to part 15 of the FCC Rules. These limits are designed to provide reasonable protection against harmful interference in a residential installation. This equipment generates, uses and can radiate radio frequency energy and, if not installed and used in accordance with the instructions, may cause harmful interference to radio communications. However, there is no guarantee that interference will not occur in a particular installation. If this equipment does cause harmful interference to radio or television reception, which can be determined by turning the equipment off and on, the user is encouraged to try to correct the interference by one or more of the following measures:

- Reorient or relocate the receiving antenna.
- Increase the separation between the equipment and receiver.
- Connect the equipment into an outlet on a circuit different from that to which the receiver is connected.
- Consult the dealer or an experienced radio/TV technician for help.