

# ASSEMBLY INSTRUCTION

## DIAMOND FRAME OTTOMAN

<b>A</b> Short Side Panel  2pcs	<b>B</b> Long Side Panel  2pcs	<b>C</b> Cushion (In other carton)  1pc
<b>D</b> Bolt 1/4"x1/2"  8pcs	<b>E</b> Bolt 5/16"x3/4"  4pcs	<b>F</b> Lock Washer 5/16"  4pcs
<b>G</b> Flat Washer 5/16"  4pcs	<b>H</b> Allen Wrench 1/4"  1pc	<b>I</b> Allen Wrench 5/16"  1pc

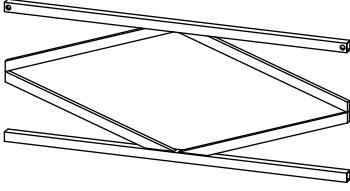
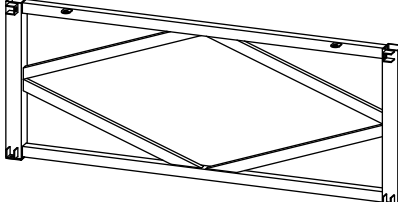
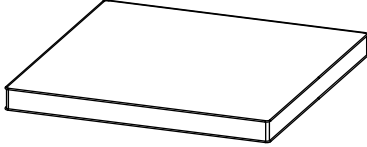
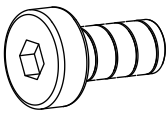
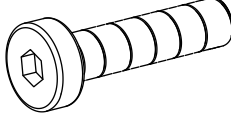
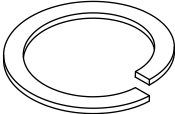
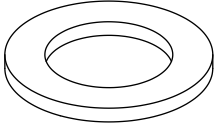
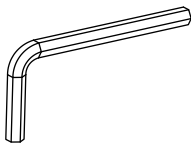
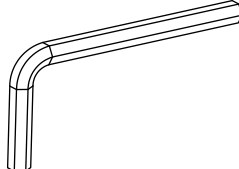
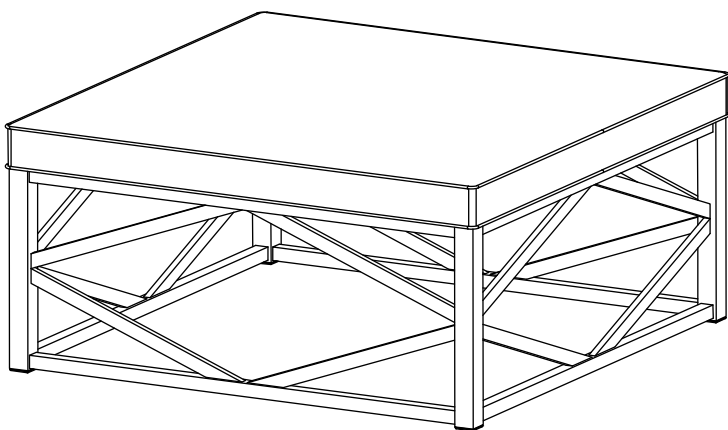

This page lists all the contents included in the box. Please take the time to identify the hardware as well as the individual components to this product. As you unpack and prepare for assembly, place the contents on a carpeted or padded area to protect them from damage.

**\*\*\* Do not tighten screws & bolts until the entire unit is completely assembled.**

- 1** First, attach long side panel (B) to short side panel (A) by using bolt (D) and allen wrench (H) as shown.

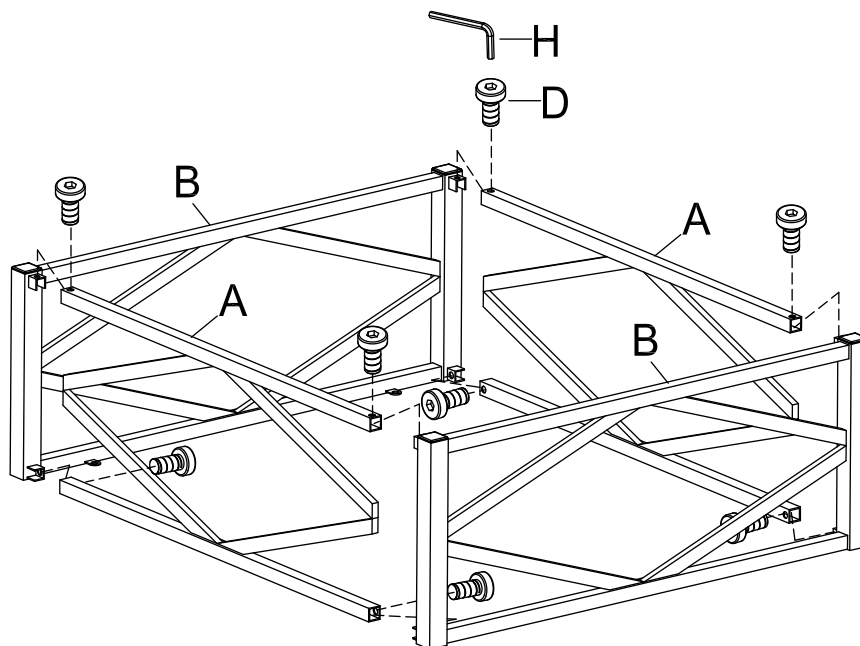

- 2** Attach the assembled metal base to cushion (C) by using bolt (E), lock washer (F), flat washer (G) and allen wrench (I) as shown.

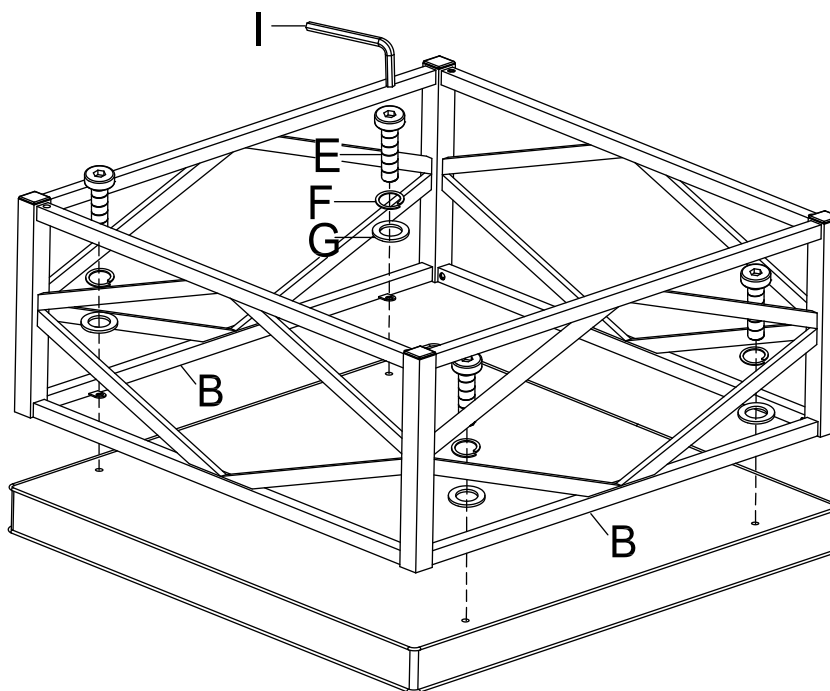

### Cleaning & Care

Treat surface with care. Surface is resistant to scratches but is not scratch resistant. Clean surfaces with a dry or damp soft cloth. Do not use abrasive cleaners. Hardware may loosen over time. Periodically check that all connections are tight.