

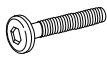











ASSEMBLY INSTRUCTION / INSTRUCTIONS DE MONTAGE

Thanks you for purchasing this product. Please take time to read and follow the instructions below. Check that you have all parts and hardware before assembly. Parts apparently missing are often found in the packing materials. If you do not have the parts listed, call us and they will be sent to you immediately.

Merci d'avoir acheté ce produit . Veuillez lire et suivre les instructions ci-dessous. Vérifiez avant le montage que vous avez toutes les pièces et fixations. Les pièces qui semblent manquer se trouvent dans les matériaux d'emballage. Si vous n'avez pas toutes les pièces de la liste, appelez-nous et nous vous les enverrons immédiatement.

No.	PARTS LIST / LISTE DE PIÈCES		Qty.	No.	HARDWARE LIST / LISTE DE QUINCAILLERIE		Qty.
A		Headboard Panel Tête de lit	1	1		JCBC M6 x 30mm VIS JCBC M6 x 30mm	6
				2		Spring Washer Ø 1/4" Rondelle a ressort Ø 1/4"	6
B		Headboard R Leg Tete de lit Leg R	1	3		Flat Washer Ø 1/4" x 13mm Rondelle Plate Ø1/4" x 13mm	6
C		Headboard L Leg Tete de lit Leg	1	4		Allen Key M4 Clé Allen M4	1
D		Footboard Panel Pied de lit	1				
E		Slats Lattes	4	5		Allen Key M5 Clé Allen M5	1
F		Support Leg Support pour transverses	4	6		CSK M4 x 32mm VIS CSK M4 x 32mm	8
G		Side Rail Longerons	2				

Above Hardware Are Packed In 1517-1 For Assembly

Above Hardware Are Packed In 1517-3 For Assembly

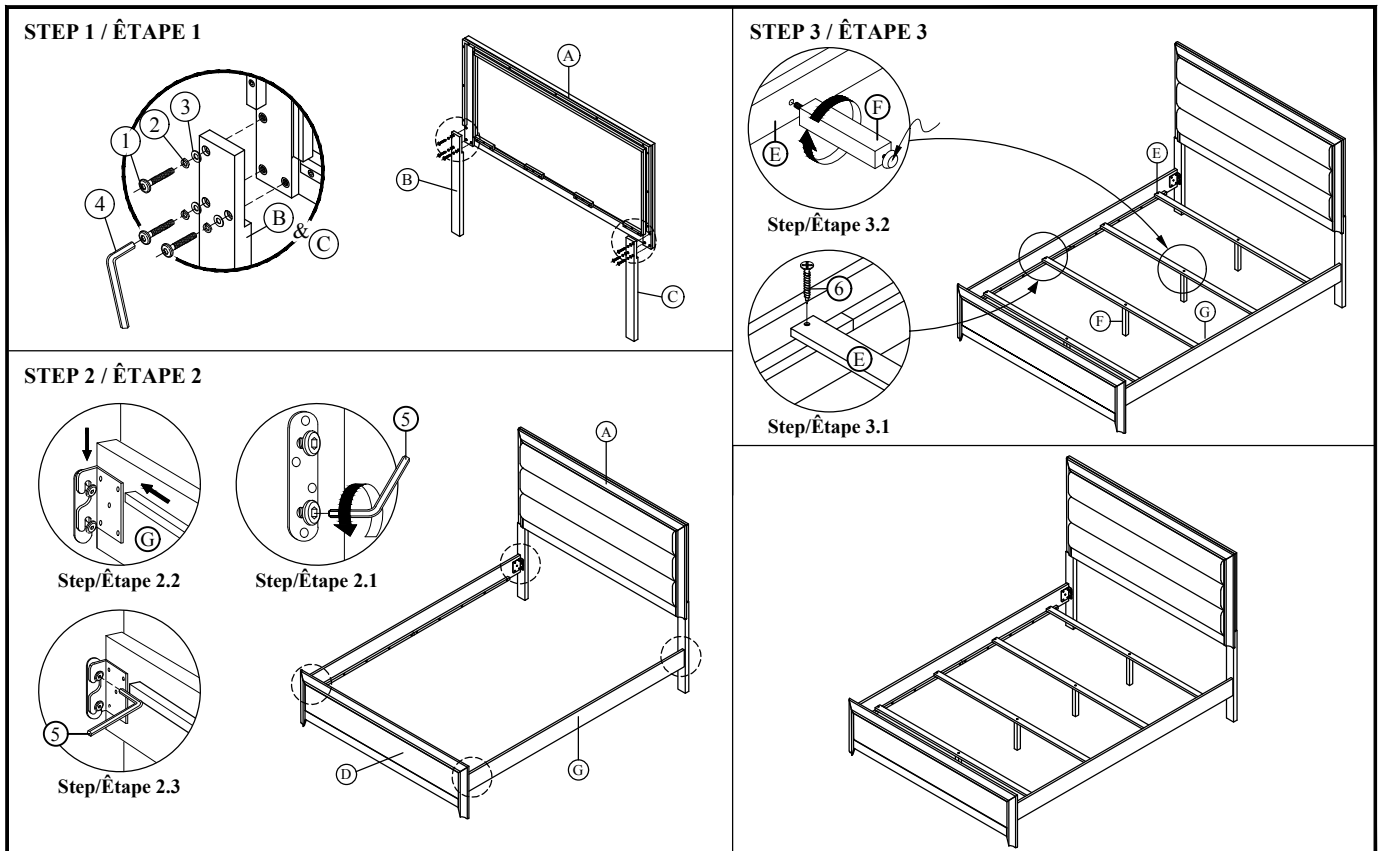

! It is recommended to install protective pads under all legs and supports to avoid damage or scratches when placing furniture on a wood floor or other hard surface, and to limit indentation and prevent discoloration if placing on carpet.

! Il est recommandé de placer des coussins protecteurs sous tous les pieds et toutes les bases des meubles pour éviter d'endommager ou d'égratigner les planchers en bois ou autres surfaces dures, et pour limiter l'empreinte et empêcher la décoloration quand les meubles reposent sur la moquette.