









ASSEMBLING INSTRUCTIONS

ITEM NO: 9916DG-LL (1/2) LSF 2-SEATER W/PULL- OUT BED
& PILLOW

9916DG-RC (2/2) RSF CHAISE W/HIDDEN STORAGE

! It is recommended to install protective pads under all legs and supports to avoid damage or scratches when placing furniture on a wood floor or other hard surface, and to limit indentation and prevent discoloration if placing on carpet.

PARTS LIST

NO.	DRAWING	QTY	DESCRIPTION
A		1 PC	RSF CHAISE
B		1 PC	CHAISE BACK REST
C		3 PCS	BACK CUSHION
D		2 PCS	PILLOW
E		1 PC	LSF 2-SEATER (leg pre-assembled)
F		1 PC	2 SEATER BACK REST
G		4 PCS	WOODEN LEG 4.5"*3-1/7"*2"
H		1 PC	WOODEN LEG 3-1/7"*3-1/7"*2"
I		10 PCS	SCREW M5*1-3/4"

STEP 1: - RC

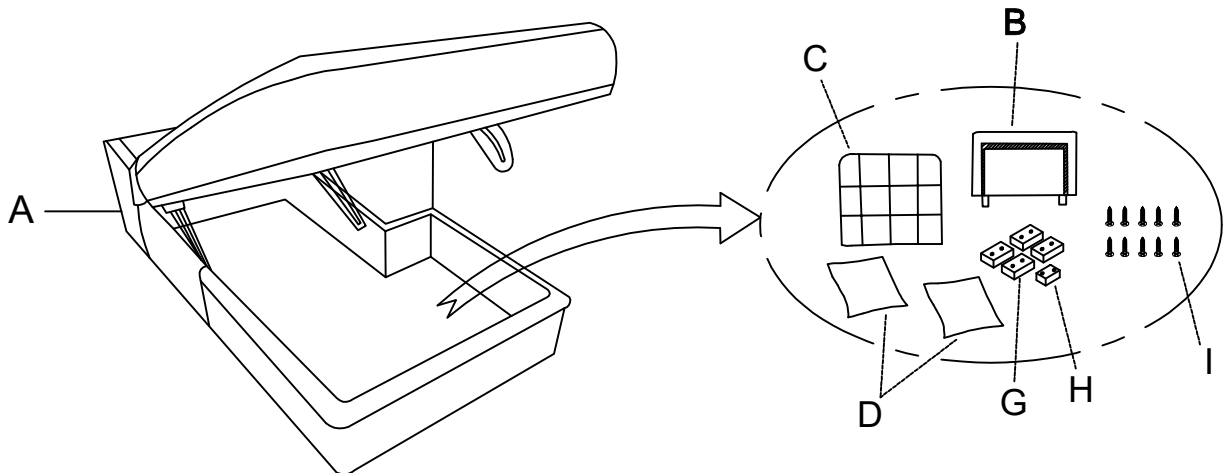



ASSEMBLING INSTRUCTIONS

ITEM NO: 9916DG-LL (1/2) LSF 2-SEATER W/PULL- OUT BED
& PILLOW

9916DG-RC (2/2) RSF CHAISE W/HIDDEN STORAGE

H O M E E L E G A N C E

STEP 2:

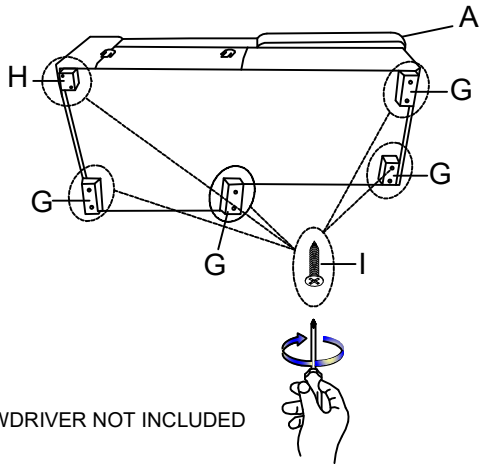

STEP 3:

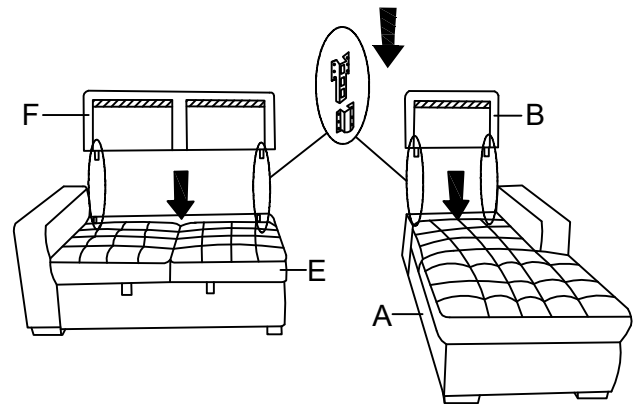

STEP 4:

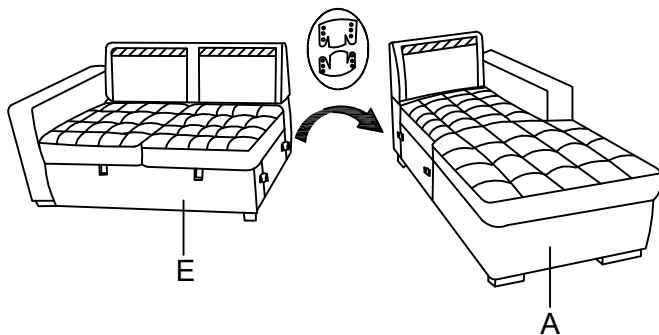

STEP 5:

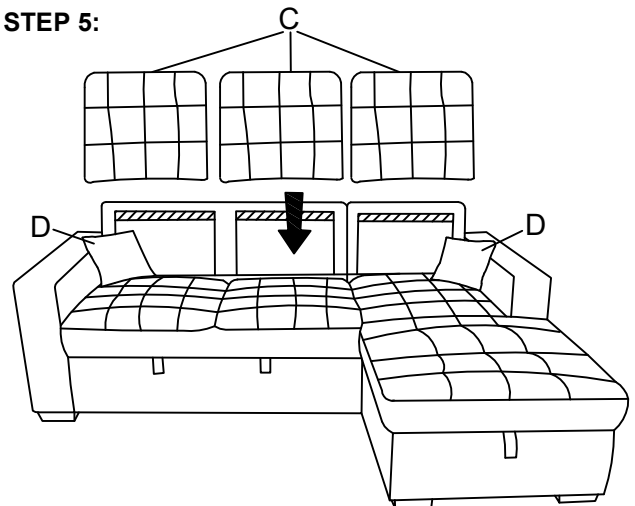

STEP 6: COMPLETED

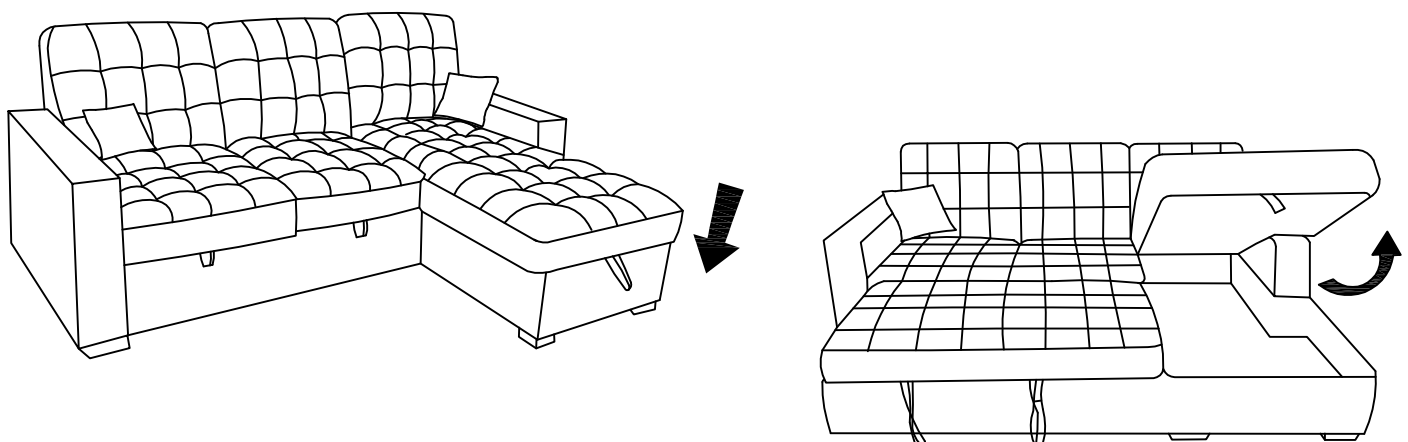

CARE INTRUCTION FOR FABRIC FURNITURE

In order to maintain the original appearance of your furnitue, please follow below care procedures.

°Avoid exposing furniture directly to sunlight or heating and air conditioning outlets. Sunlight and / or exposure to headding and air conditioning outlets will fade/damage fabric. Do not place your upholstered furniture too close to windows, radiators, r vents and be sure to use window treatments to block the sun's rays.

°Wipe with a soft brush to remove dust.