

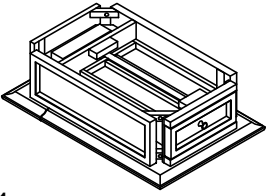

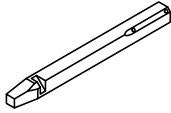

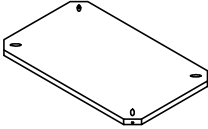

ASSEMBLY INSTRUCTION

E720A(3A) END TABLE WITH POWER OUTLET

| | | | |
|---|--|--|--|
| A Table Top  1pc | B Leg  4pcs | C Shelf Panel  1pc | D Screw Ø5/32"x32mm  4pcs |
| E Bolt Ø1/4"x2"  8pcs | F Lock Washer Ø1/4"  8pcs | G Flat Washer Ø1/4"x19x1.5mm  8pcs | H Allen Key M4  1pc |
| I Screwdriver (Not Provided)  1pc | | | |

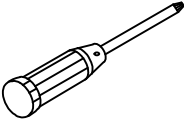
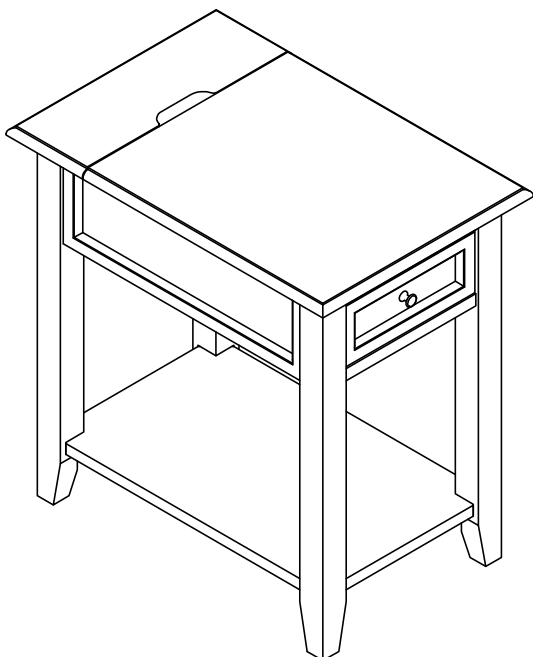

This page lists all the contents included in the box. Please take the time to identify the hardware as well as the individual components to this product. As you unpack and prepare for assembly, place the contents on a carpeted or padded area to protect them from damage.

- 1** Put Table Top (A) on a smooth flat surface, pull out the drawer from Table Top (A). Attach 3pcs of Leg (B) to Table Top (A) using Bolt (E), Flat Washer (G) and Lock Washer (F) by Allen Key (H).

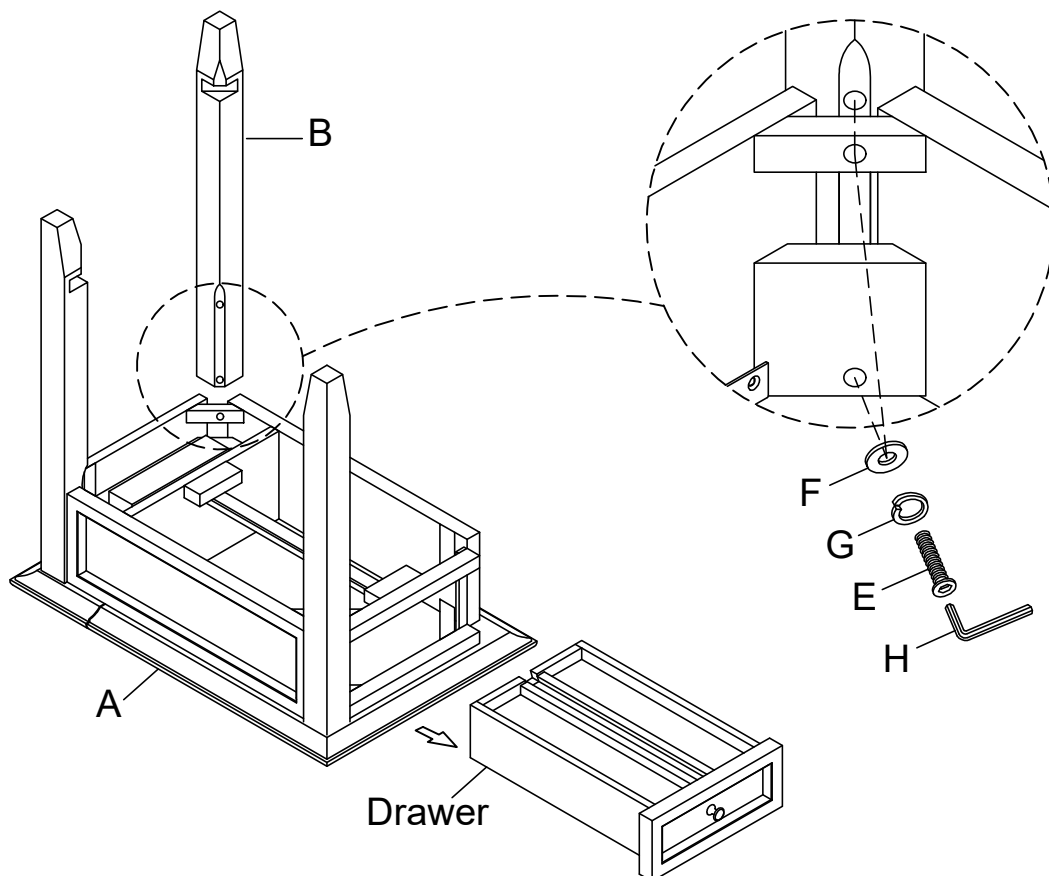

- 2** Attach Shelf Panel (C) to the assembled Leg (B), then assemble the rest 1pc Leg (B) to Table Top (A) and Shelf Panel (C). Next, using Screw (D) to lock the Shelf Panel (C) with Leg (B) by Screwdriver (I) and using Bolt (H), Lock Washer (G) & Flat Washer (F) to lock the last one Leg (B) with Table Top (A).

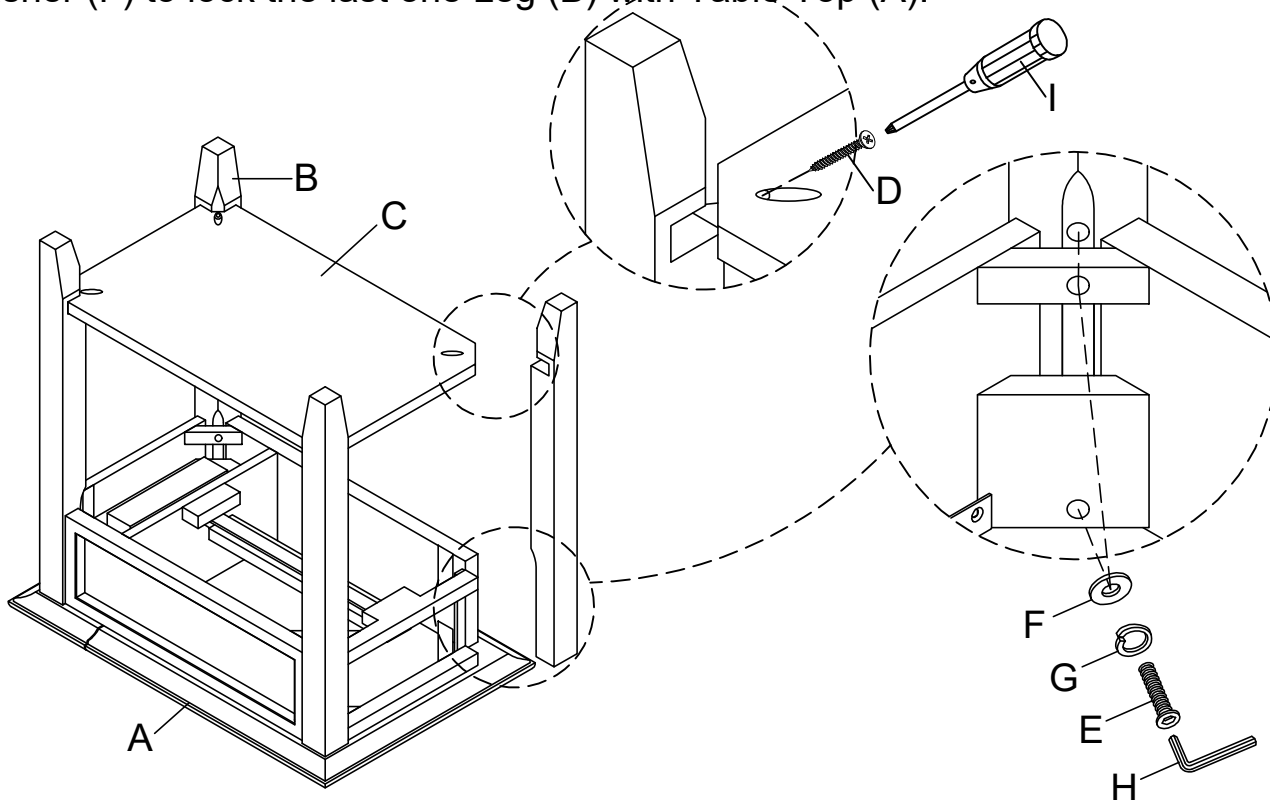

- 3** Put the drawer back into Table Top (A), then open the Cover Panel of Table Top (A) and connect the power as below shown.

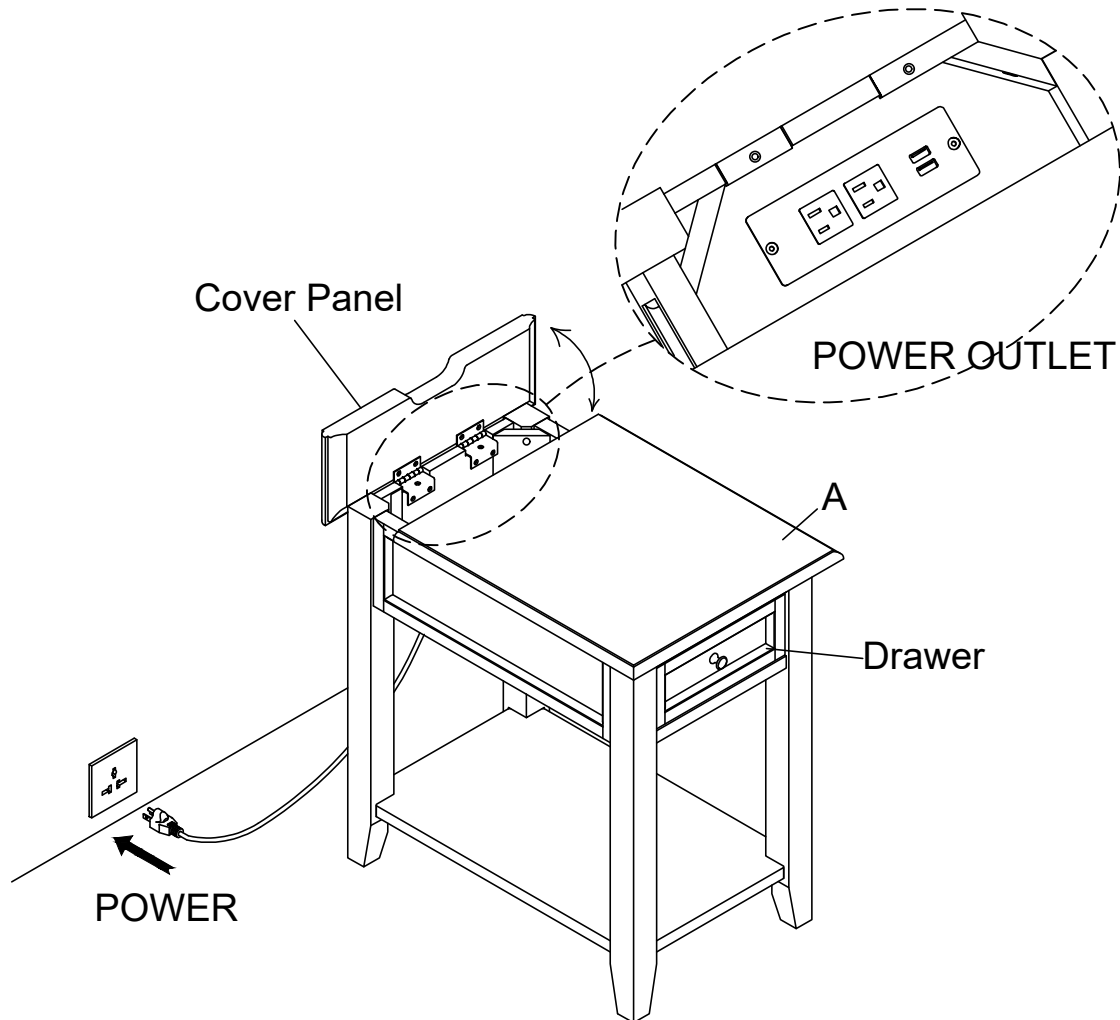

Cleaning & Care

Treat surface with care. Surface is resistant to scratches but is not scratch resistant. Clean surfaces with a dry or damp soft cloth. Do not use abrasive cleaners. Hardware may loosen over time. Periodically check that all connections are tight.