







HEKMAN

ASSEMBLY INSTRUCTION 24103 LAMP TABLE DRAWER

HARDWARE LIST

Part	Item	Description	Qty
1.		Bolt BO M8 x 20 mm	16 pcs
2.		JCBC Bolt M6 x 20mm	4 pcs
3.		Flat Washer 8 x 20	16 pcs
4.		Flat Washer 6 x 15	4 pcs
5.		Allen Key L4	1 pc
6.		Wrench	1 pc

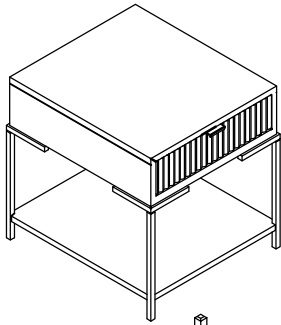

Step#1

1. Lay top upside down on soft clean surface

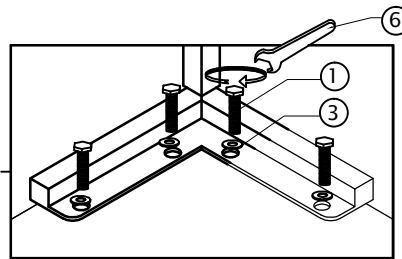
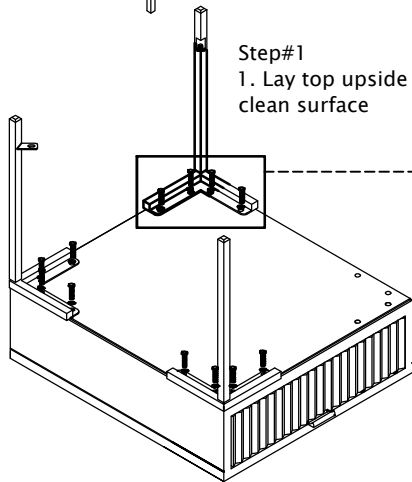

Step#2

1. Attach 3 legs using Bolts(1), Flat Washer(3) and Wrench(6). Do not tighten bolts completely.

Step#3

1. Attach Shelf to the 3 legs attached to top assembly in step#2 using JCBC Bolts(2), Flat Washer(4) and Allen key(5).

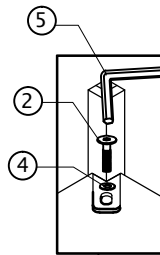

Step#4

1. Attached the fourth leg to top assembly and shelf using Bolts(1), Flat Washer(3) and Wrench(6) for the top assembly and JCBC Bolts(2), Flat Washer(4) and Allen Key(5) for the shelf.

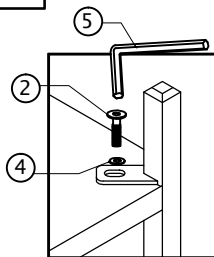

Step#5

1. Tighten all Bolts completely
2. Turn Lamp Table with Drawer Upright.

