

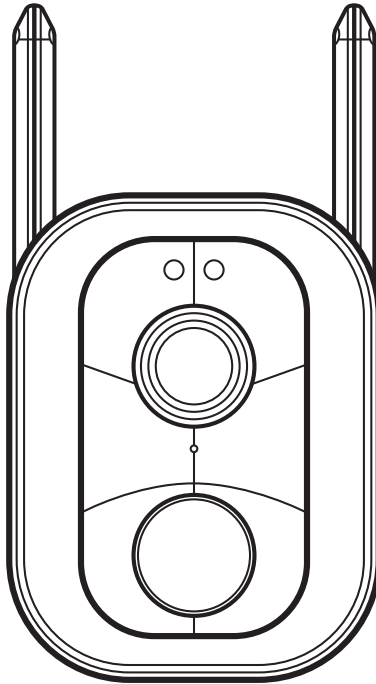

Thank you for your purchase. Questions, comments or feedback? We'd love to hear from you.  
Visit [feit.com/help](https://feit.com/help) for support.

# SMART OUTDOOR CAMERA

## IMPORTANT SAFETY INSTRUCTIONS AND INSTALLATION GUIDE



Works with  
  
Feit Electric app

  
Only supports  
2.4GHz Wi-Fi  
Networks

**READ BEFORE INSTALLATION.  
SAVE THESE INSTRUCTIONS.**

Questions, problems, missing parts? Before returning to the store,  
contact Feit Electric Customer Service  
8 a.m. - 5 p.m., PST, Monday - Friday

**FEIT.COM**

REV032025

We appreciate the trust and confidence you have placed in Feit Electric through the purchase of this product. We strive to continually create quality products designed to enhance your home. Visit us online to see our full line of products available for your home improvement needs. Thank you for choosing Feit Electric.

# Table of Contents

Safety Information .....	2
FCC Statement .....	2
Warranty .....	2
Pre-Assembly .....	3
Description .....	3
Wall Mount Installation .....	4
Solar Panel Connection (optional) .....	5
APP Setup .....	5
Troubleshooting .....	6

## Safety Information

### IMPORTANT SAFEGUARDS:

ALWAYS FOLLOW BASIC SAFETY PRECAUTIONS WHEN USING ELECTRICAL PRODUCTS, ESPECIALLY WHEN CHILDREN ARE PRESENT.



**CAUTION:** Please read all information carefully before installation.



**CAUTION:** Intended for outdoor use. May be used indoors.



**CAUTION:** CONTAINS NON-REPLACEABLE LITHIUM-ION BATTERY(IES).



**CAUTION:** Only use 5VDC 1A adapter (not included) for charging. Risk of fire, explosion, and burns. Do not disassemble, crush, or incinerate. Intended for indoor and outdoor use. This product is not user-serviceable. Do not attempt to open the product enclosure for any reason. Reliable operating temperature is 32°F (0°C) to 113°F (45°C).

### Supplier's Declaration of Conformity:

47 CFR § 2.1077 Compliance Information

### Responsible Party:

Feit Electric Company  
4901 Gregg Road,  
Pico Rivera, CA 90660, USA  
562-463-2852

### Unique Identifier:

CAM/WM/WIFI/BAT

This device complies with part 15 of the FCC Rules. Operation is subject to the following two conditions: (1) This device may not cause harmful interference, and (2) this device must accept any interference received, including interference that may cause undesired operation. Note: This equipment has been tested and found to comply with the limits for a Class B digital device, pursuant to part 15 of the FCC Rules. These limits are designed to provide reasonable protection against harmful interference in a residential installation. This equipment generates, uses and can radiate radio frequency energy and, if not installed and used in accordance with the instructions, may cause harmful interference to radio communications. However, there is no guarantee that interference will not occur in a particular installation. If this equipment does cause harmful interference to radio or television reception, which can be determined by turning the equipment off and on, the user is encouraged to try to correct the interference by one or more of the following measures: Reorient or relocate the receiving antenna. Increase the separation between the equipment and receiver. Connect the equipment into an outlet on a circuit different from that to which the receiver is connected. Consult the dealer or an experienced radio/TV technician for help. Any changes or modifications not expressly approved by the manufacturer could void the user's authority to operate the equipment.

The device has been evaluated to meet general RF exposure requirement.  
The device can be used in portable exposure condition without restriction.  
The device can be used in mobile (min 7.87 in.) exposure condition without restriction.

### Radiation Exposure Statement

This device complies with FCC radiation exposure limits set forth for an uncontrolled environment. This device should be installed and operated with a minimum distance of 20cm between the radiator and your body.

## Limited Warranty

This product is warrantied to be free from defects in workmanship and materials for up to 1 year from date of purchase. If the product fails within the warranty period, please visit [feit.com/help](http://feit.com/help) for instructions on replacement/refund or call 866.326.BULB. REPLACEMENT OR REFUND IS YOUR SOLE REMEDY. EXCEPT TO THE EXTENT PROHIBITED BY APPLICABLE LAW, ANY IMPLIED WARRANTIES ARE LIMITED IN DURATION TO THE DURATION OF THIS WARRANTY. LIABILITY FOR INCIDENTAL OR CONSEQUENTIAL DAMAGES IS HEREBY EXPRESSLY EXCLUDED. Some states and provinces do not allow the exclusion of incidental or consequential damages, so the above limitation or exclusion may not apply to you. This warranty gives you specific legal rights, and you may also have other rights which vary from state to state or province to province.

## TOOLS REQUIRED TO MOUNT CAMERA

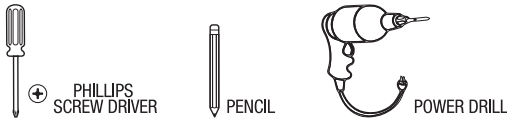

## HARDWARE INCLUDED

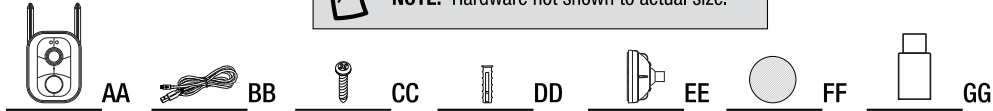

**NOTE:** Hardware not shown to actual size.

Part	Description	Quantity
AA	Camera	1
BB	USB Cord	1
CC	Mounting Screws	2
DD	Mounting Anchors	2
EE	Adjustable Mounting Bracket	1
FF	Circular Foam Adhesive <small>(Circular foam adhesive is used to protect the wall from dents and scratches.)</small>	1
GG	Micro USB to USB-C Adapter	1

## Description

**NOTE:** Before installing, fully charge the battery using the provided USB Cord (BB) by plugging it into a power source.

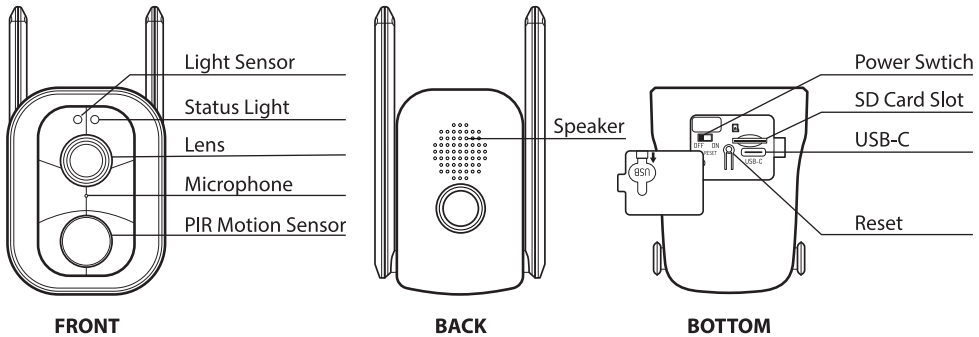

Input Power (USB-C): 5VDC, Max. 1A	
<b>Power Switch</b>	Slide Switch to one side to Turn off or On
<b>Status Light</b>	Blinking RED = Pairing Mode Solid RED = No Wi-Fi Connection Blinking BLUE = Connecting to Wi-Fi Solid BLUE = Connected to Wi-Fi
<b>SD Card Slot</b>	Add 128GB or less microSD card to enable recording (not included). Only supports microSD card with FAT32 format.
<b>Reset</b>	Press and hold for 5 seconds on the Reset button to reset the camera.
<b>Charging LED Indicator</b>	Solid Red: Battery is charging Light is Off: Charging is complete
<b>Battery Capacity</b>	3.7V / 6600mAh (3 x 18650 Built-in) 10 hours charging full from depleted battery. Up to 45 days (based on 10 motion triggers per day/ 10 seconds per trigger).

## 1 Mark Screw Positions

Turn anticlockwise to open the cover of the Adjustable Mounting Bracket (EE). Mark screw positions using the Adjustable Mounting Bracket Plate on your wall.

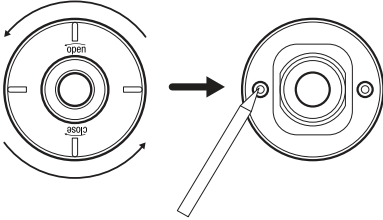

## 2 Inserting the Mounting Anchors

Drill holes at the marked points if installing on a hard surface such as concrete or brick. Insert Mounting Anchors (DD) into holes. You can skip this step if installing on wood or siding.

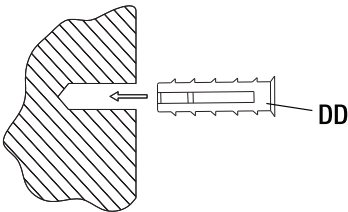

## 3 Attaching the Bracket

Use the Mounting Screws (CC) to attach the Adjustable Mounting Bracket Plate (EE) to the wall.

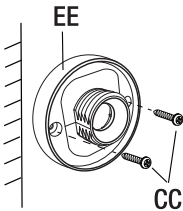

## 4 Attaching the Camera

Ensure the Camera (AA) is on by switching it to the ON position. Adjust the direction of the Camera (AA) and twist onto the Adjustable Mounting Bracket (EE) until it is firm.



**NOTE:** Adjustable mount provides 360° swivel and 90° of tilt.

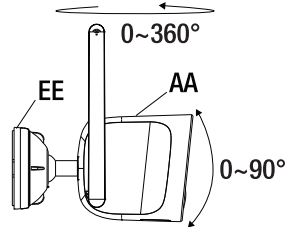
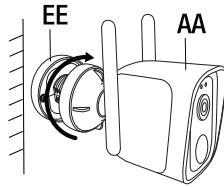

## 5 Adjusting the Camera

Slightly loosen the Camera (AA) off the cover of the Adjustable Mounting Bracket (EE) in order to adjust more accurately.



**NOTE:** After adjusting the camera angle, rotate the white knob clockwise to lock.

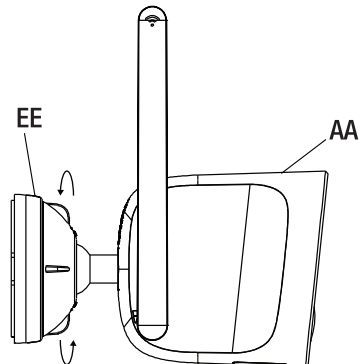

# Solar Panel Connection (optional)



**NOTE:** This camera is only compatible with Feit model **PANEL/SOL/CAM (sold separately)**.

## 1 Connecting Directly to a Solar Panel

If your version of Feit model PANEL/SOL/CAM is with a USB-C cord, connect the solar panel directly to the camera's (AA) USB-C port.

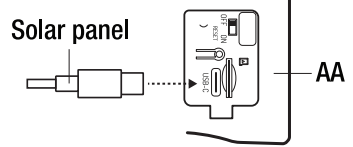

## 2 Connecting to a Solar Panel with a Micro USB to USB-C Adapter

If your version of Feit model PANEL/SOL/CAM is with a Micro USB cord, use the Micro USB to USB-C Adapter (GG) to connect the solar panel to the camera's (AA) USB-C port.

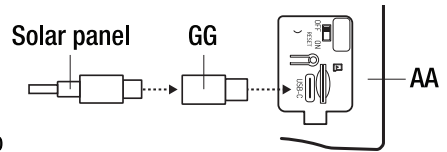

## APP Setup

### Downloading and Installing the Feit Electric app

- Search for the Feit Electric app in the App Store or Google Play Store.
- Download and install the Feit Electric app on your smart device.



Feit Electric App



### Setting up the Camera with the Feit Electric app

- Check to be sure the camera is in pairing mode. The RED indicator light must be blinking rapidly to connect. If not already blinking, press and hold the Reset Button until you hear an audible tone. Use the Feit Electric app to complete the set up.
- Tap Add Device or the + sign, then select Camera and confirm. You will be prompted to enter your Wi-Fi network and password.
- Follow the directions in the app to pair your device using the QR code.



**NOTE:** Be sure to connect to a 2.4 GHz Wi-Fi network that covers your installation location.

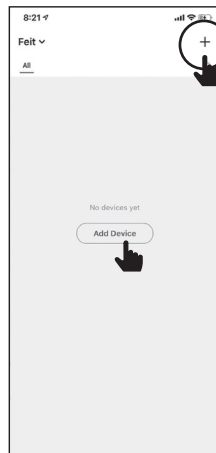

Hold the phone approximately 6-12 inches from the camera and wait for the tone.

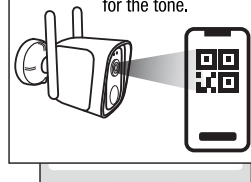

PROBLEM	CORRECTIVE ACTION
Camera will not connect to my Wi-Fi network	<ul style="list-style-type: none"> <li>• Make sure the LED is blinking red. If the LED is not blinking red, you will need to press and hold Reset Button located behind the cover at the back of the camera (see the Description section).</li> <li>• Make sure the Wi-Fi network is a 2.4GHz network, device will not connect to a 5GHz network.</li> <li>• Test your Wi-Fi network with other devices such as your phone or computer to make sure it is operating properly.</li> <li>• The Wi-Fi connection may be out of range during pairing. Use your phone to check range, it is recommended to have at least 2 signal bars showing for proper connection.</li> <li>• Your Wi-Fi network password is case sensitive, make sure you are entering it correctly.</li> </ul>
The camera is offline	<ul style="list-style-type: none"> <li>• There could be a temporary issue with your internet connection (e.g., service disruption). Please try again in a few minutes.</li> <li>• Make sure your Wi-Fi router is turned On.</li> <li>• The camera may not have power to it, make sure the wall switch and breaker is in the On position.</li> <li>• Make sure the camera is getting a good signal from your Wi-Fi router. Use your phone to check range, it is recommended to have at least 2 signal bars showing for proper connection.</li> <li>• The camera may have been disconnected from your Wi-Fi network, press and hold Reset Button (see the Description section) until you see a blinking red LED and hear an audible tone.</li> </ul>
What do the blinking LEDs mean?	<ul style="list-style-type: none"> <li>• Blinking RED = Pairing Mode</li> <li>• Solid RED = No Wi-Fi Connection</li> <li>• Blinking BLUE = Connecting to Wi-Fi</li> <li>• Solid BLUE = Connected to Wi-Fi</li> </ul>
Live video stream is slow to load	<p>Camera streaming issues may be caused by any of the following:</p> <ul style="list-style-type: none"> <li>• Your phone's cellular connection, which relies on mobile coverage.</li> <li>• Limited internet bandwidth at home. For example, other video streaming services running at the same time on your network can cause congestion slowing down the internet upload and download speeds.</li> <li>• Wi-Fi reception may not be stable or work reliably if the camera's Wi-Fi signal strength is less than 2 signal bars. You may need to install a Wi-Fi repeater or extender to boost the Wi-Fi signal.</li> </ul>
How do I reset the camera to reenter pairing mode?	<ul style="list-style-type: none"> <li>• Press and hold reset button located at the back of the camera (see the Description section) until you see a blinking red LED and hear an audible tone.</li> </ul>
The camera is not recording	<ul style="list-style-type: none"> <li>• Make sure Record Button is turned On in app, under SD Card Settings. This is located in the Settings menu on the upper right corner in the control panel.</li> <li>• Make sure that the microSD card is installed correctly. To confirm the camera is recognizing the microSD card, go to the SD Card Settings in the Settings menu and make sure microSD Card Capacity menu shows Total Capacity, Used and Free Space. If this does not appear you may consider reformatting the microSD card.</li> </ul> <p>WARNING: Reformatting microSD card will delete all videos stored on card. Please go through the troubleshooting section before doing so or contact our Customer Support Team.</p>
How can I check the available space on the SD Card?	<ul style="list-style-type: none"> <li>• In the Settings menu under SD Card Settings, you will see Used Space and Free Space.</li> </ul> <p>Note: Camera only supports 128GB or less microSD cards with FAT32 format.</p>
What happens when the microSD card reaches full capacity?	<ul style="list-style-type: none"> <li>• Once the microSD card reaches full capacity, new videos will start rewriting (deleting) over the oldest videos.</li> </ul>
Can I use a new microSD card if I do not want to record over existing videos?	<ul style="list-style-type: none"> <li>• Yes, you can use a new microSD card if you do not want to record over existing videos by removing the back cover on the camera and replacing the existing microSD card with a new one as long as it does not exceed 128GB. Once this is completed you will need to format the microSD card by going to the SD Card Settings in the Settings menu and pressing Format SD Card then Confirm.</li> </ul> <p>WARNING: Reformatting microSD card will delete all content stored on card.</p>

SD™, microSD™, and SDHC™ are trademarks or registered trademarks of SD-3C, LLC in the United States, other countries, or both.



## Need Help?

Thank you for your purchase. Questions, comments or feedback? We'd love to hear from you  
Visit [feit.com/help](http://feit.com/help) for support or connect with us:



@FeitElectric

@FeitElectricInc

feitelectricleighting