

2504769-V HENLEY 2-4 PERSON SLANT ROOF SAUNA Container Loading Diagram

(1 set=6 boxes 40 sets/40HQ, 22 pallets/ 40HQ, Gross Weight: 14520kg)

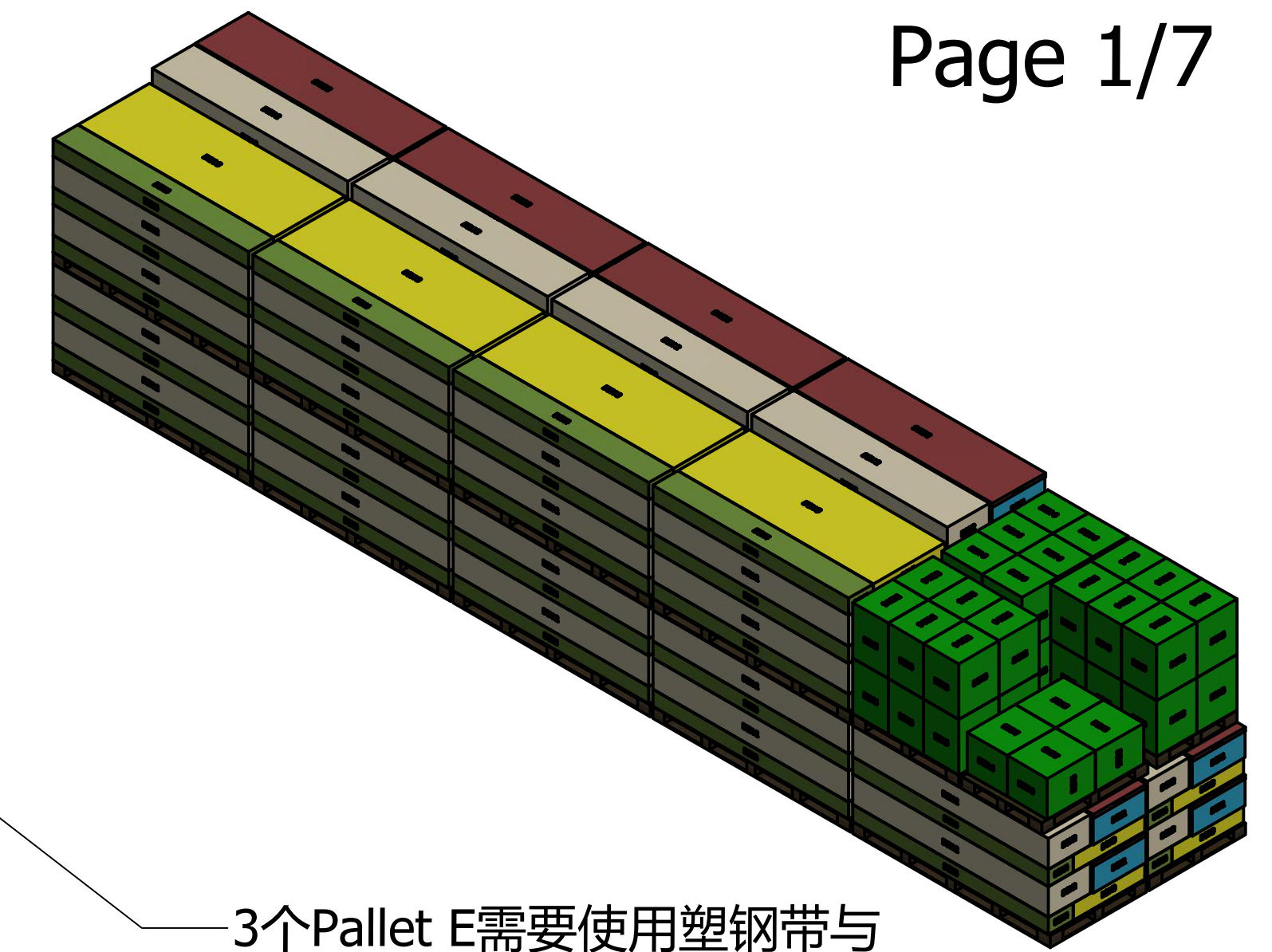

3个Pallet E需要使用塑钢带与底部对应的Pallet A在长度方向进行固定,避免运输过程中滑动。最后单独装载Pallet D,并在柜尾部用塑钢带打十字叉进行固定。

Top view

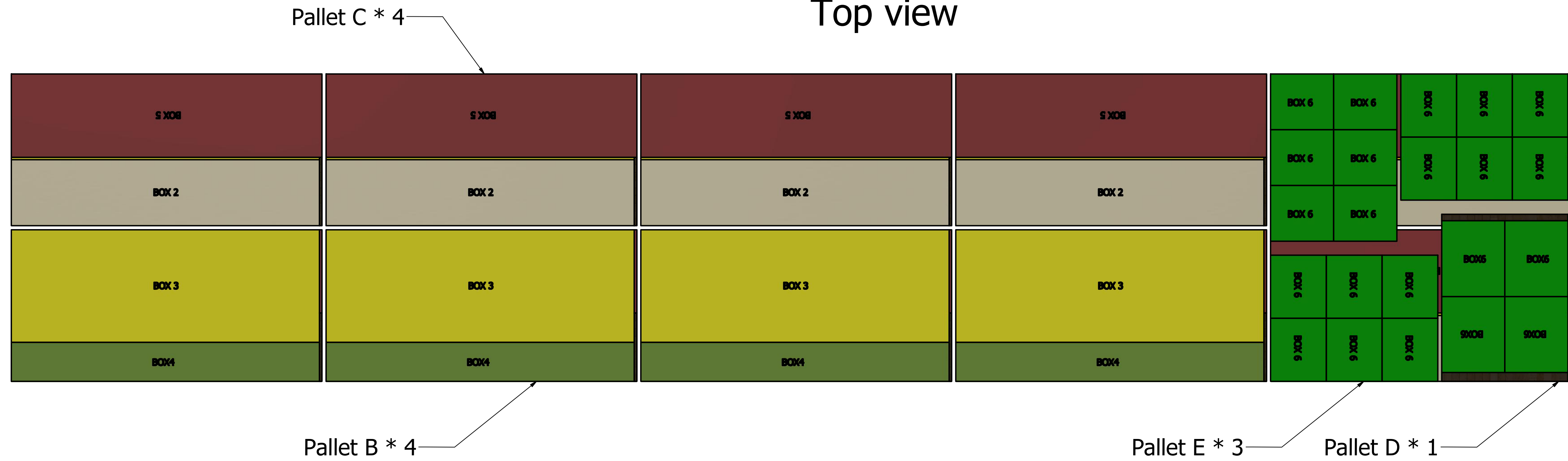

Side view

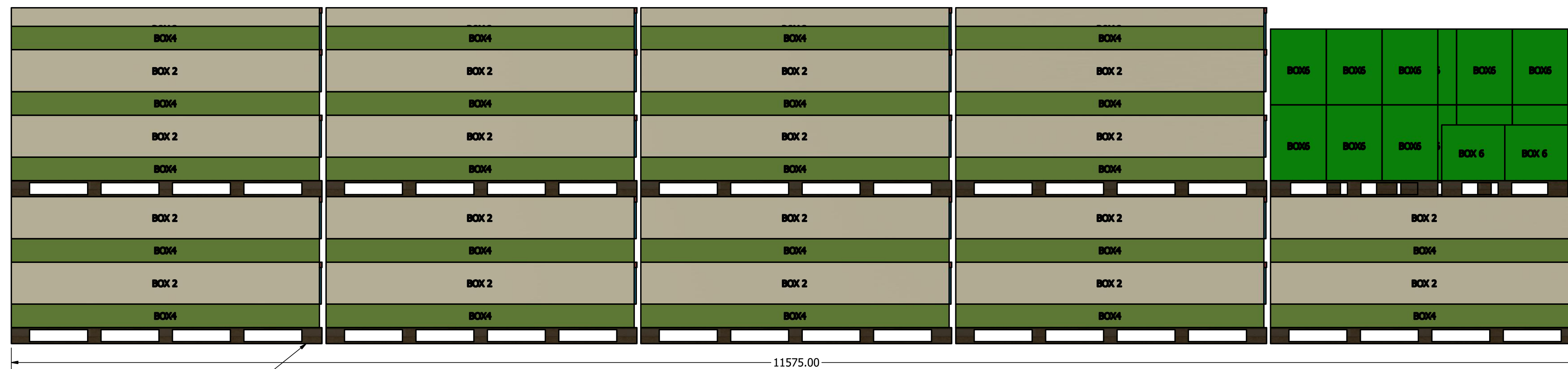

End view

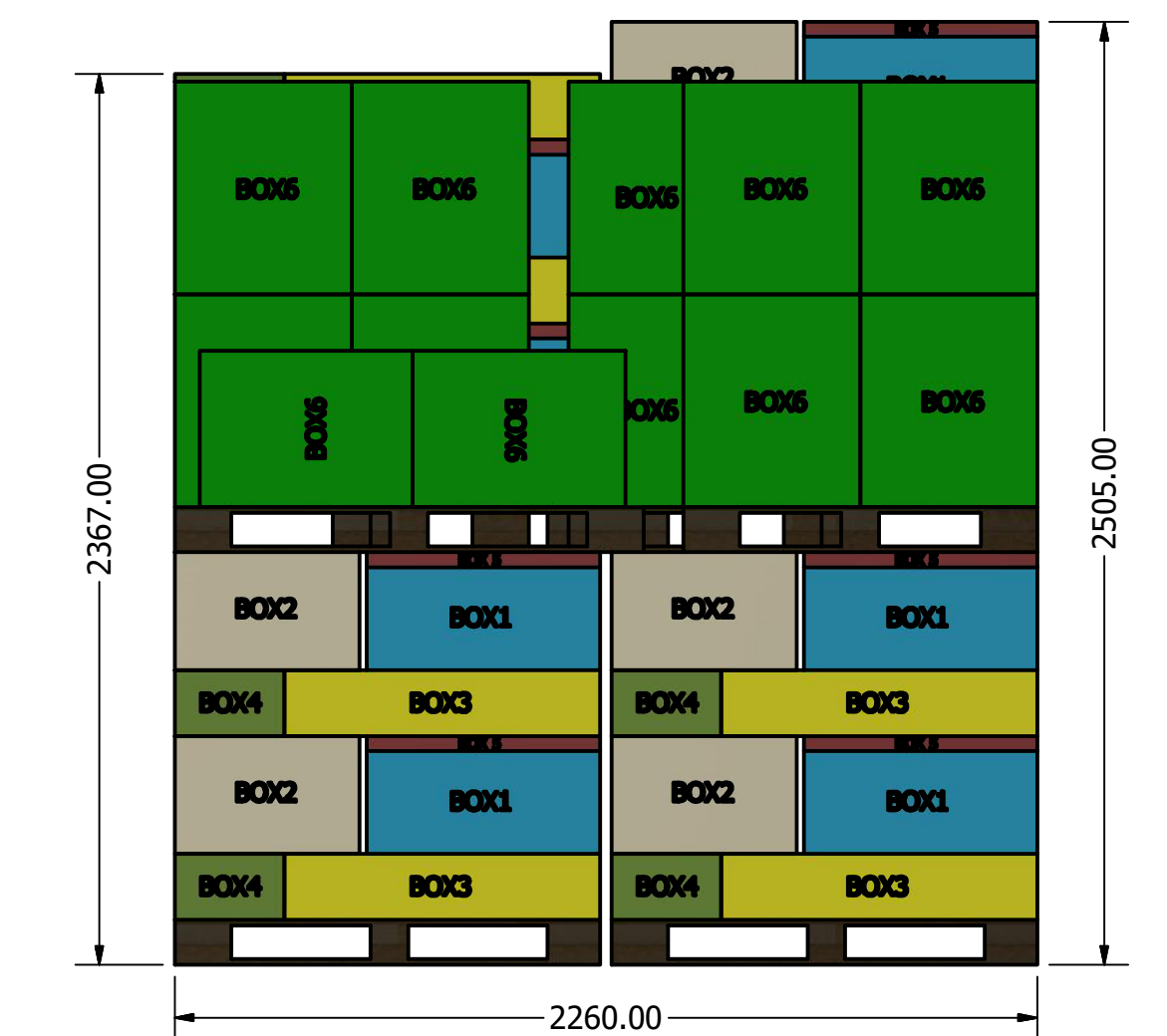

Pallet A * 10

DRAWN	Rudy	2019/8/19		
CHECKED			TITLE	
QA				
MFG				
APPROVED				
			SIZE	DWG NO
			D	2006522
			SCALE	1 / 20
			SHEET 1 OF 1	

Pallet A (2 sets/pallet)

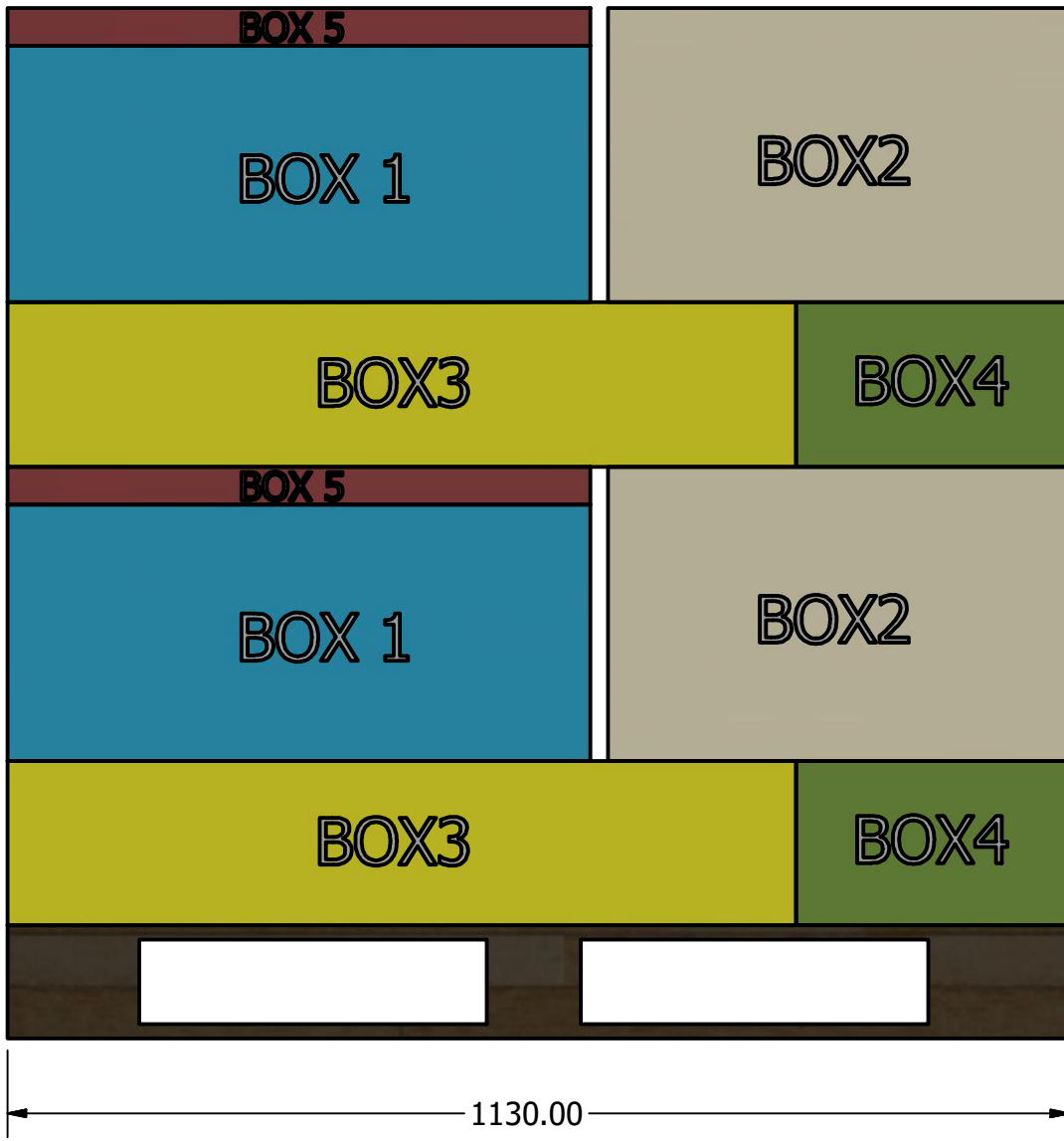
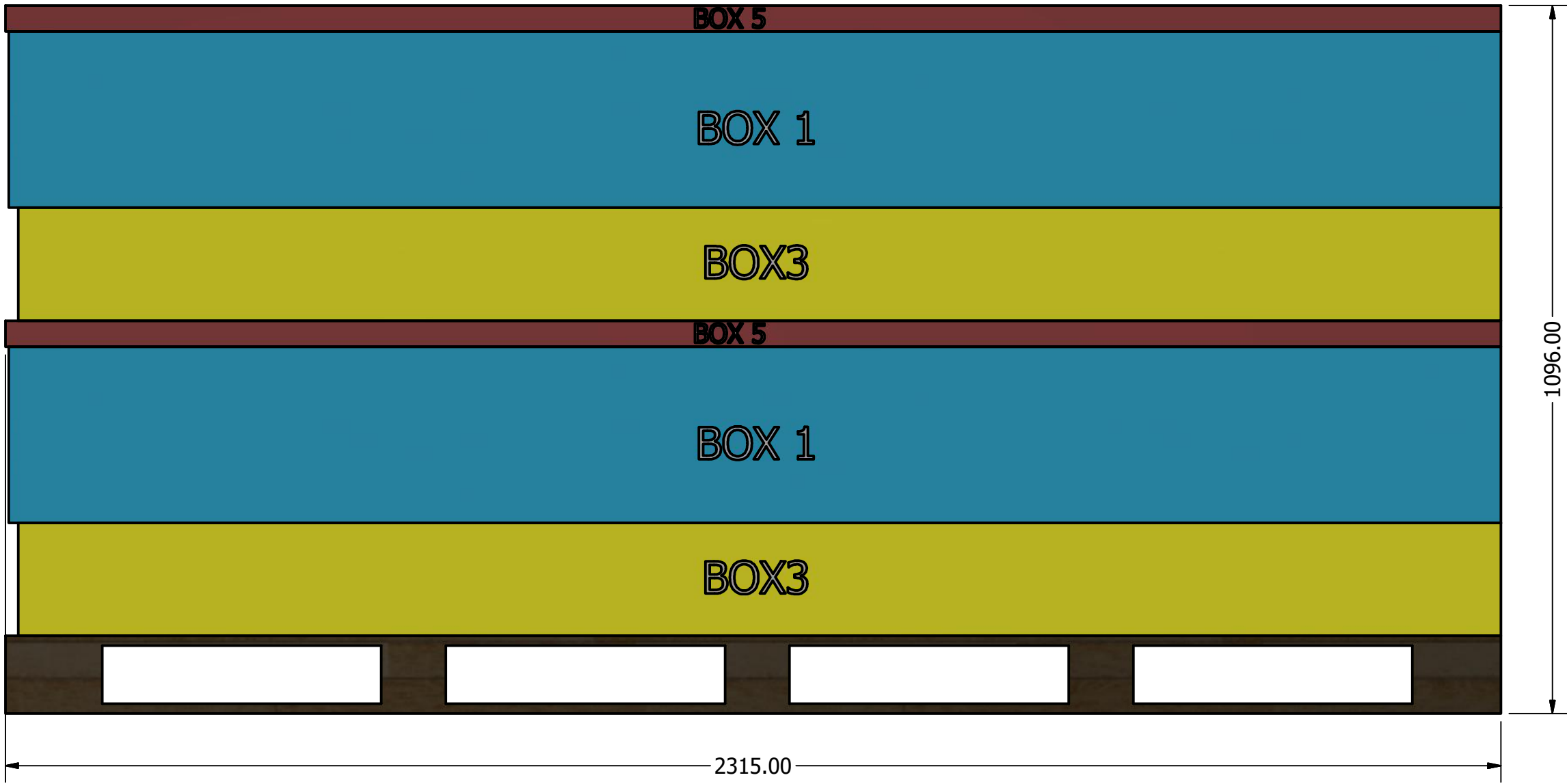
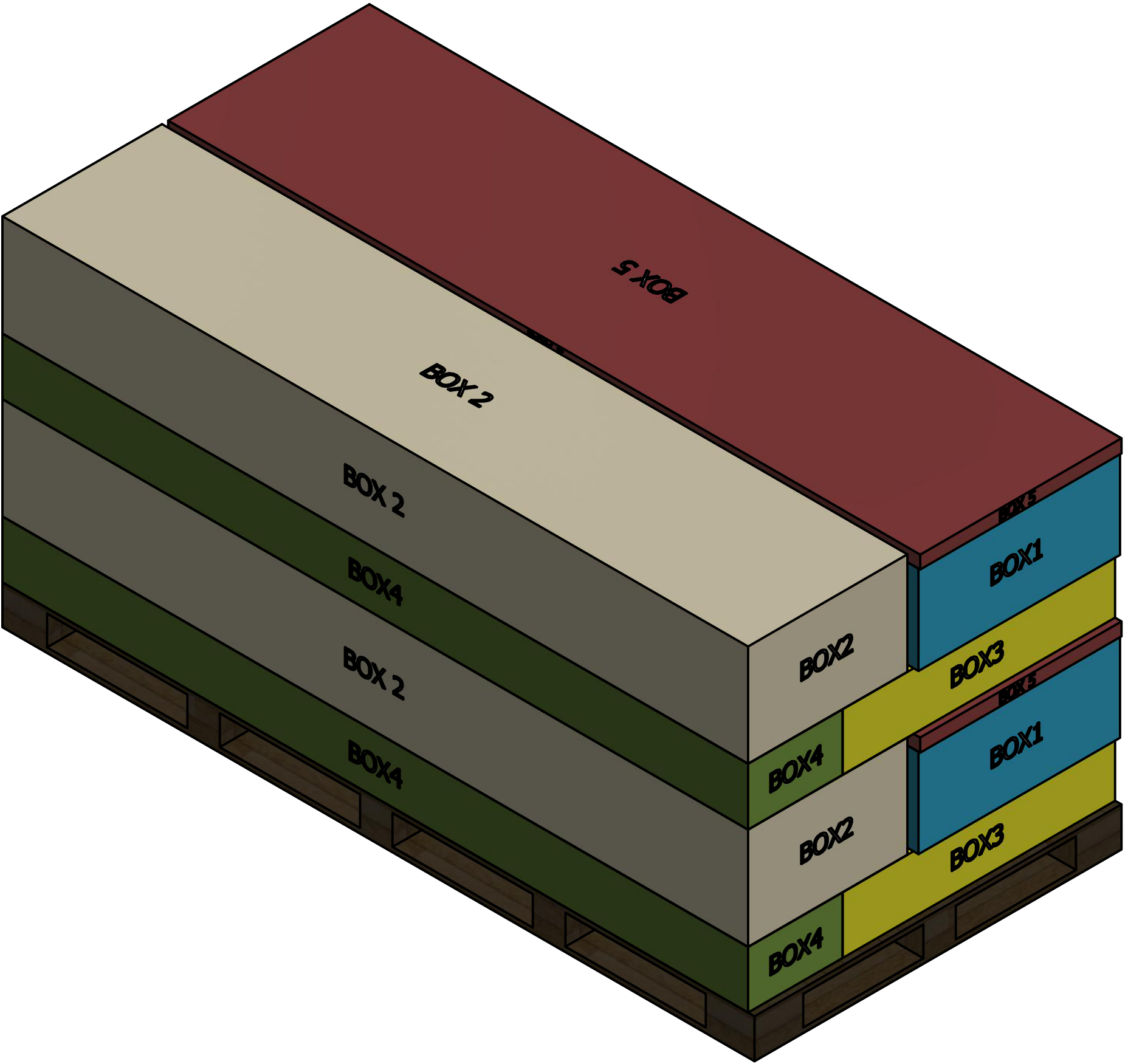
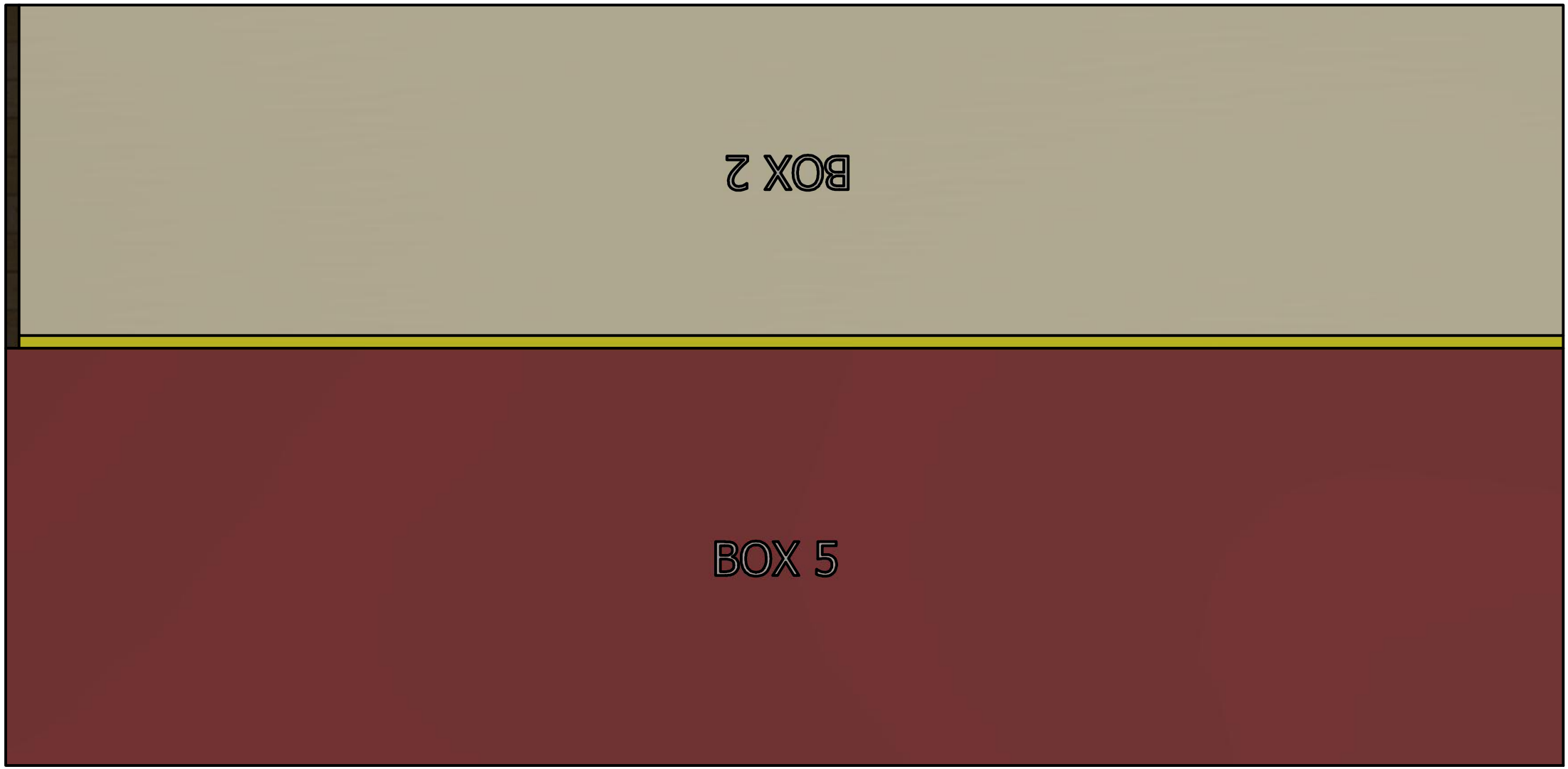

DRAWN		TITLE		
CHECKED		TITLE		
QA		TITLE		
MFG		TITLE		
APPROVED		TITLE		
		SIZE D	DWG NO	REV
		SCALE 1 : 10	SHEET 1 OF 1	

Pallet B (2 sets+BOX3*1+BOX4*1)

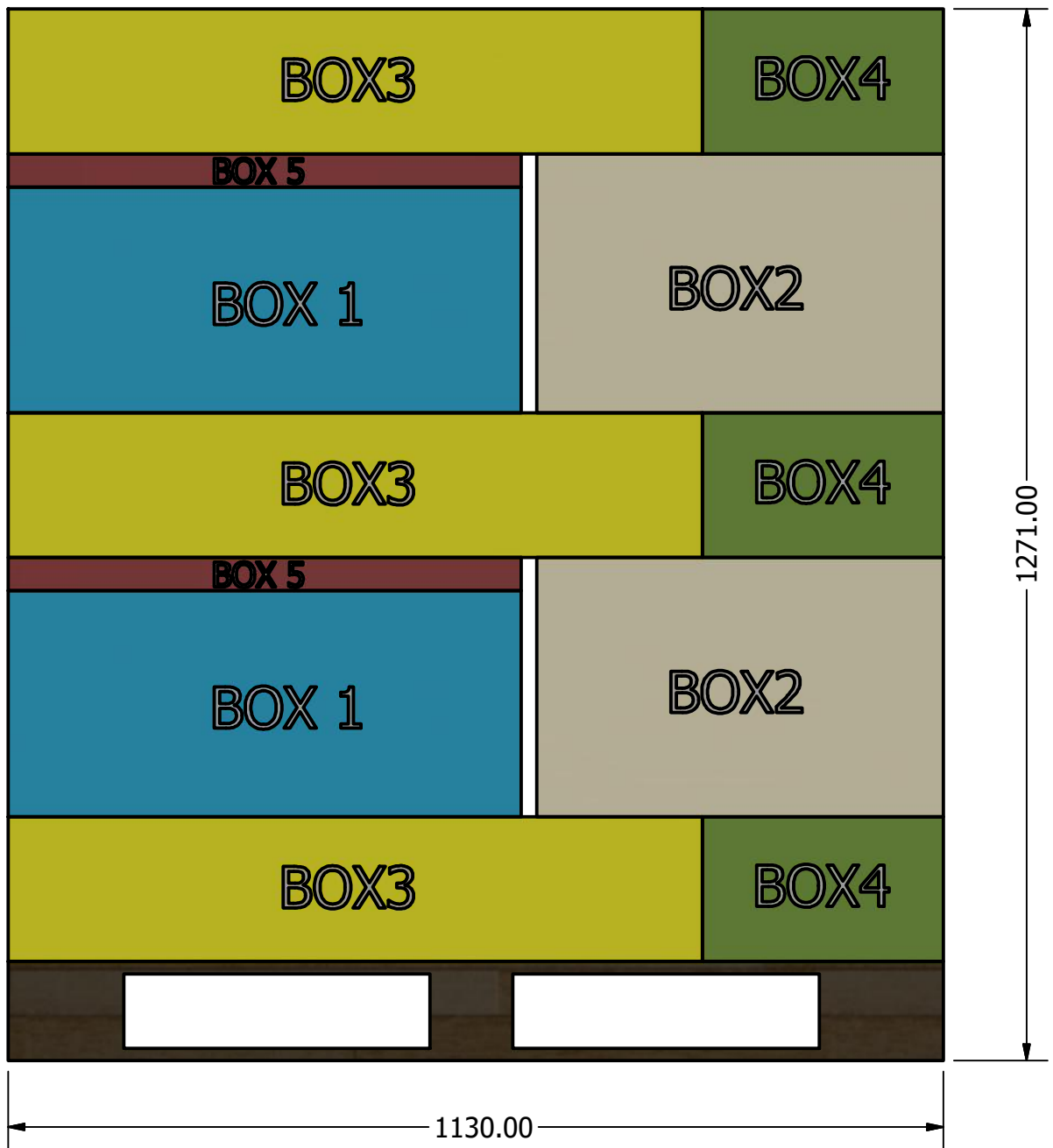
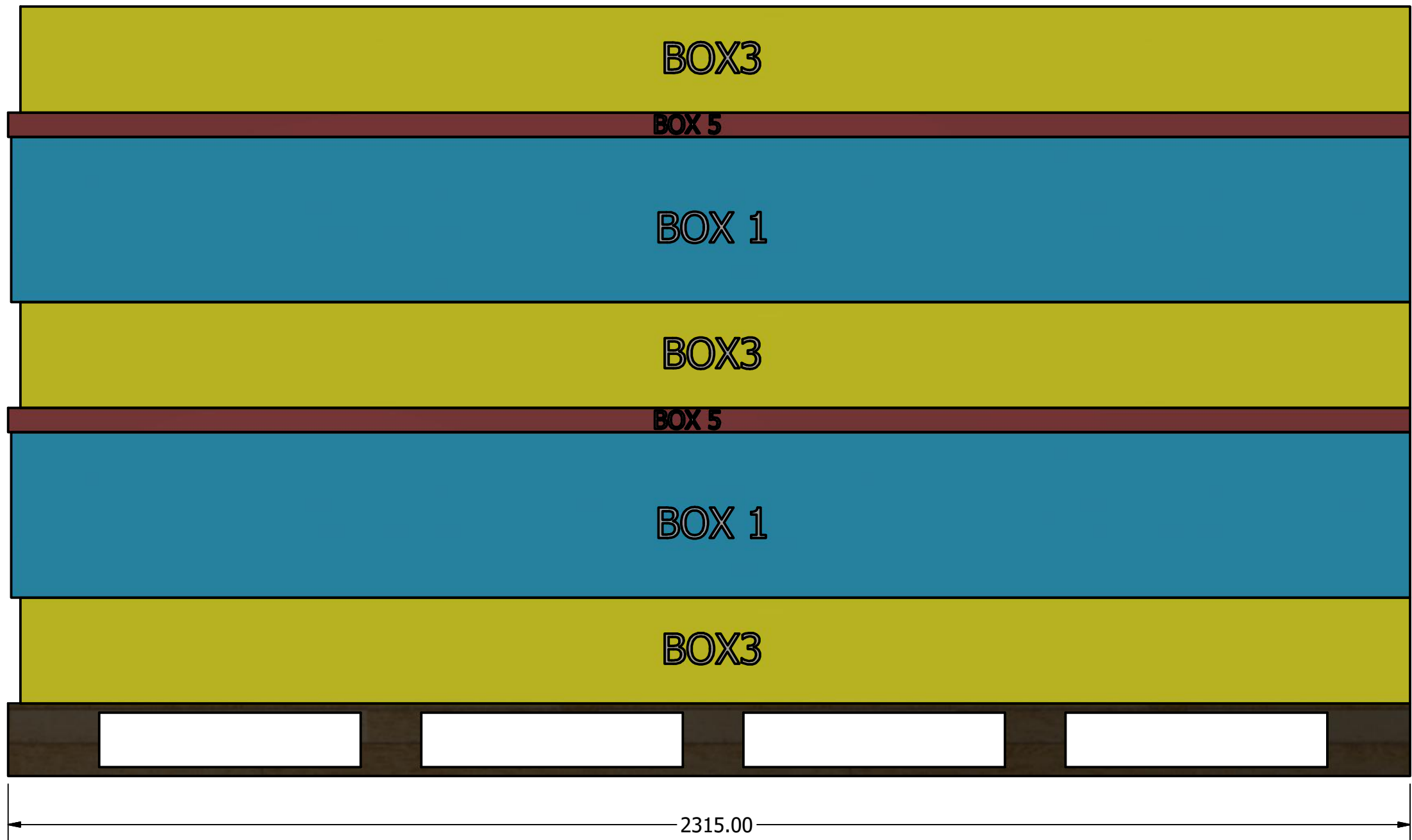
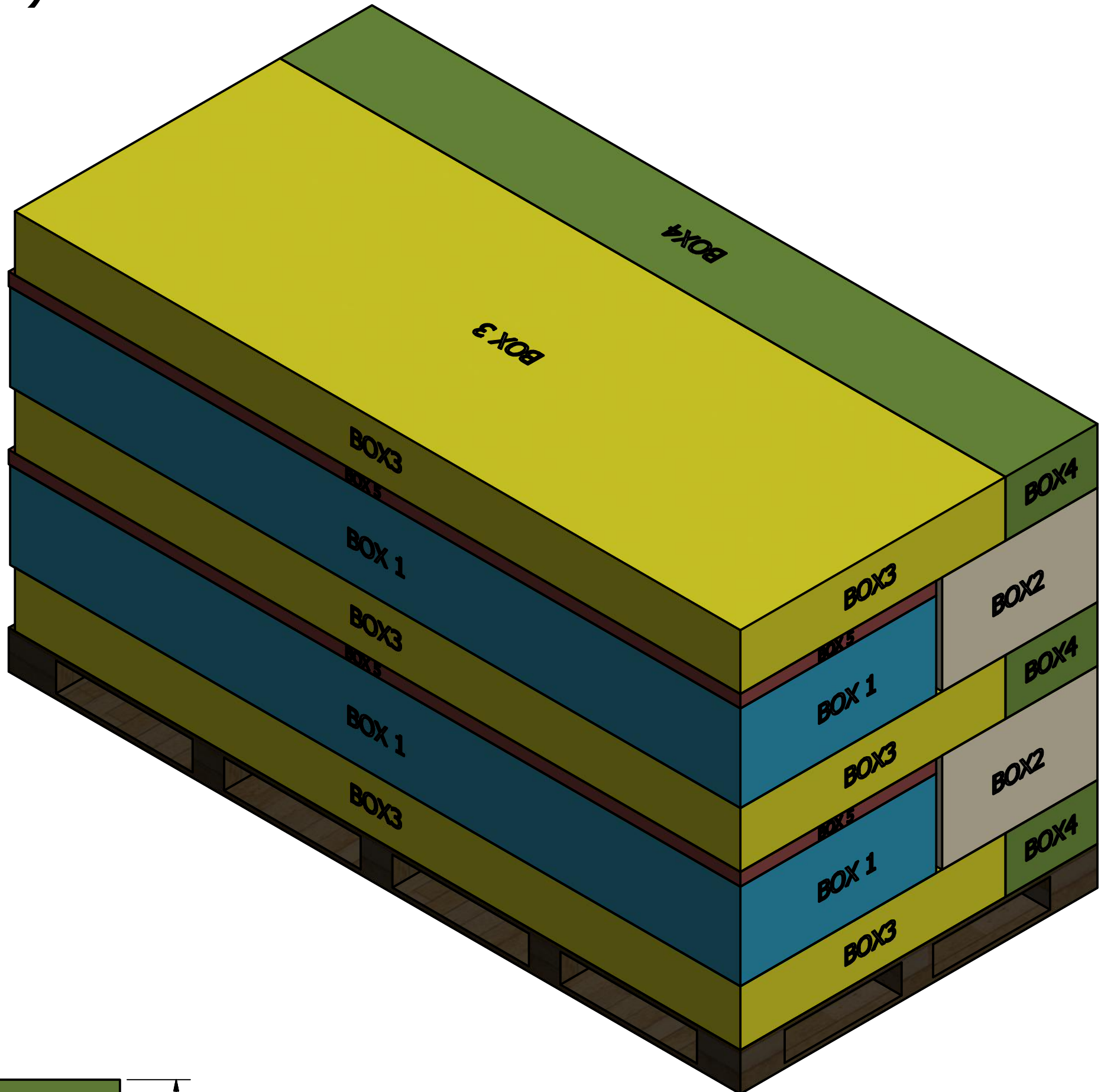

DRAWN		TITLE		
CHECKED				
QA				
MFG				
APPROVED				
		SIZE D	DWG NO	REV
		SCALE 1: 8	SHEET 1 OF 1	

Pallet C (2 sets+BOX1*1+BOX2*1+BOX5*1)

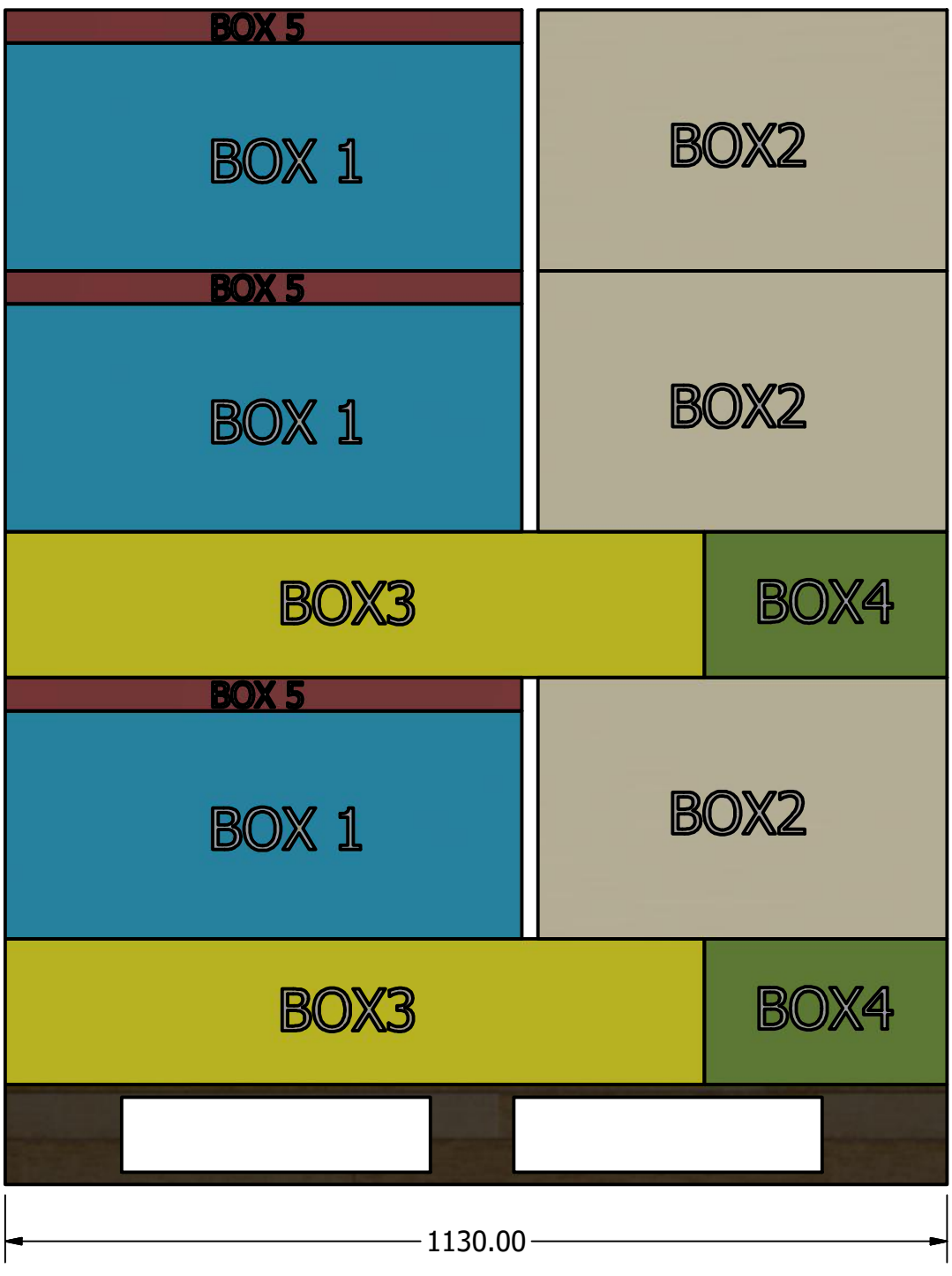
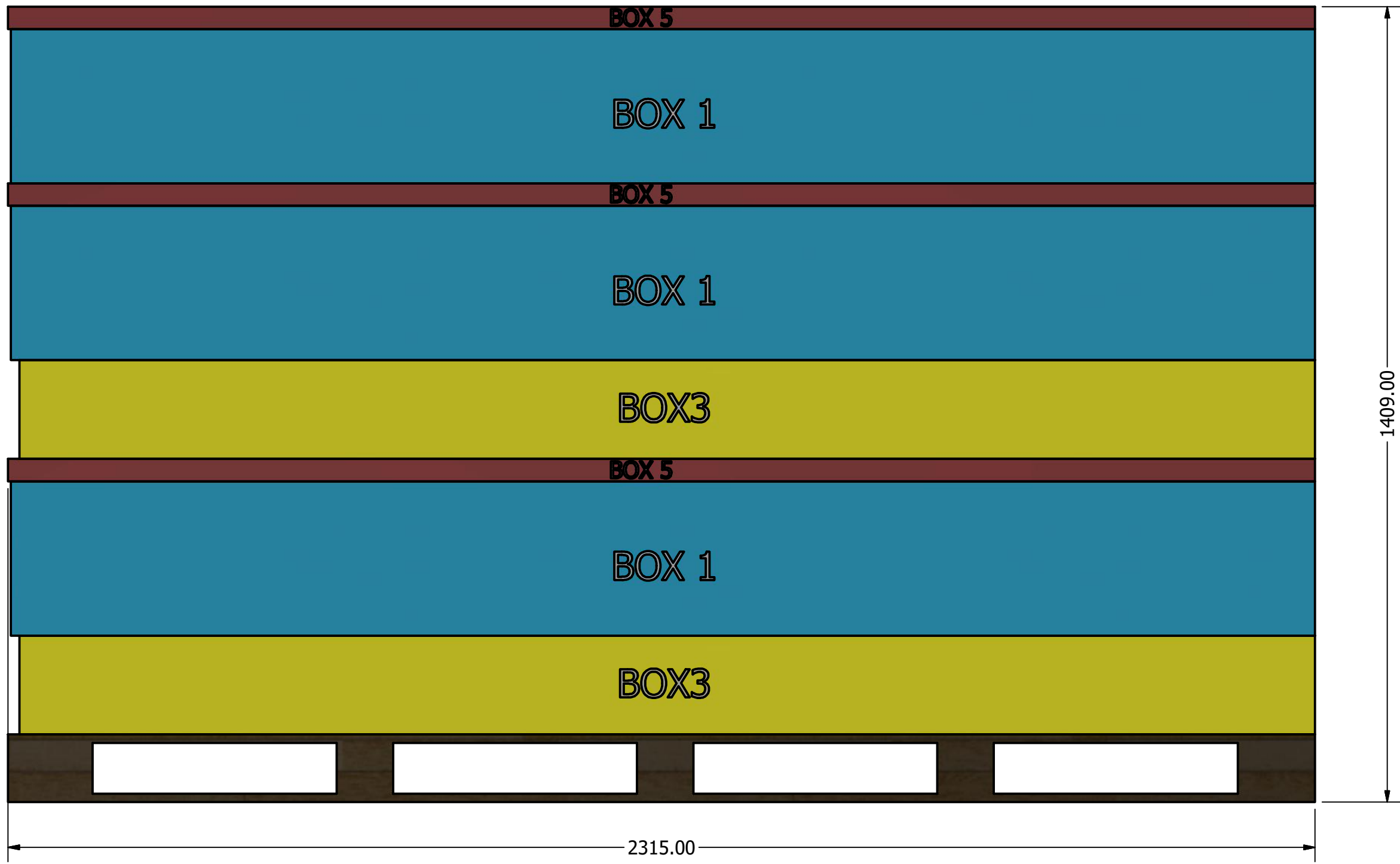
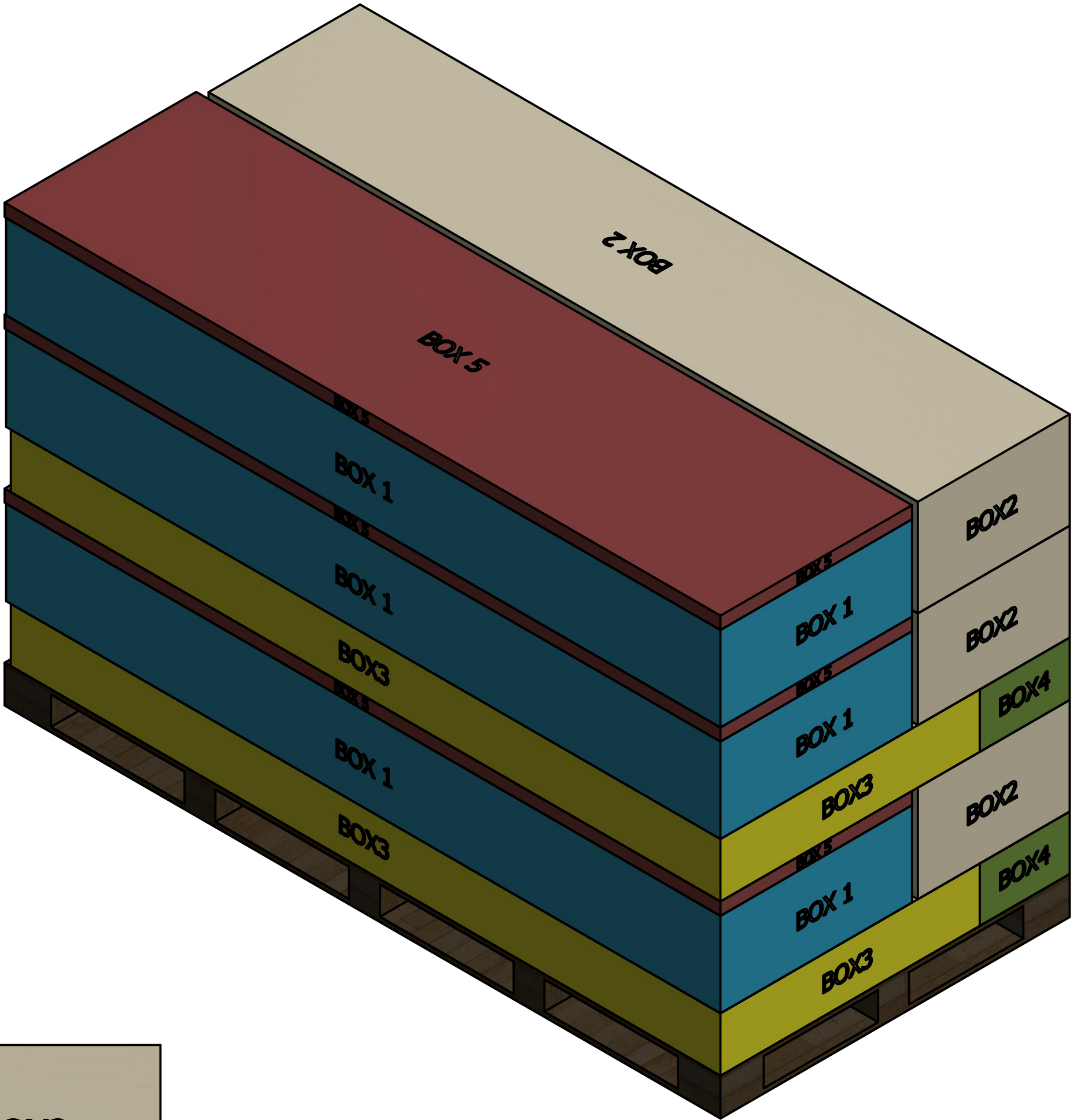
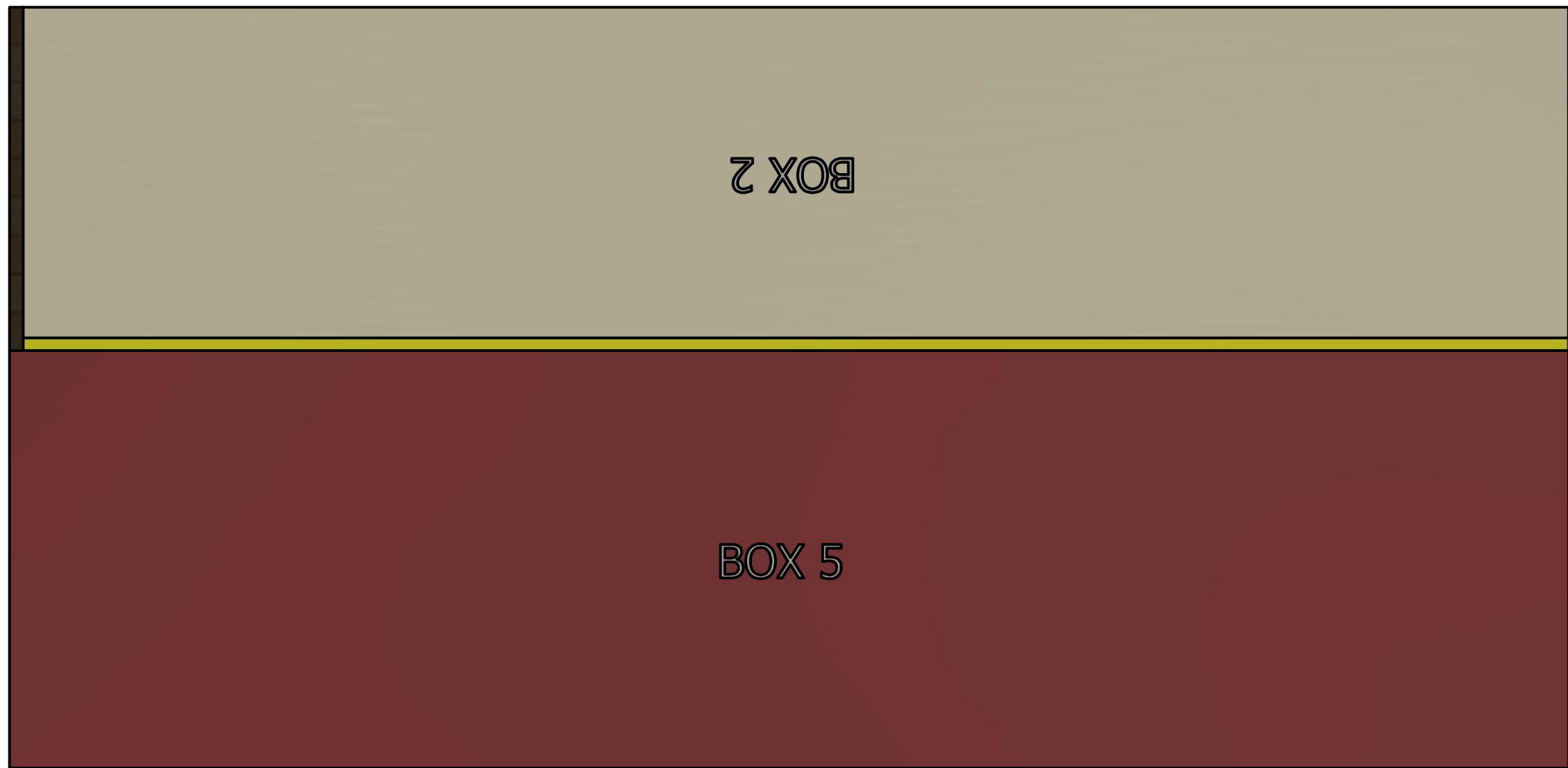

DRAWN		TITLE		
CHECKED				
QA				
MFG				
APPROVED				
		SIZE	DWG NO	REV
		D		
		SCALE	SHEET 1 OF 1	
		1 : 8		

Pallet D (BOX6*4)

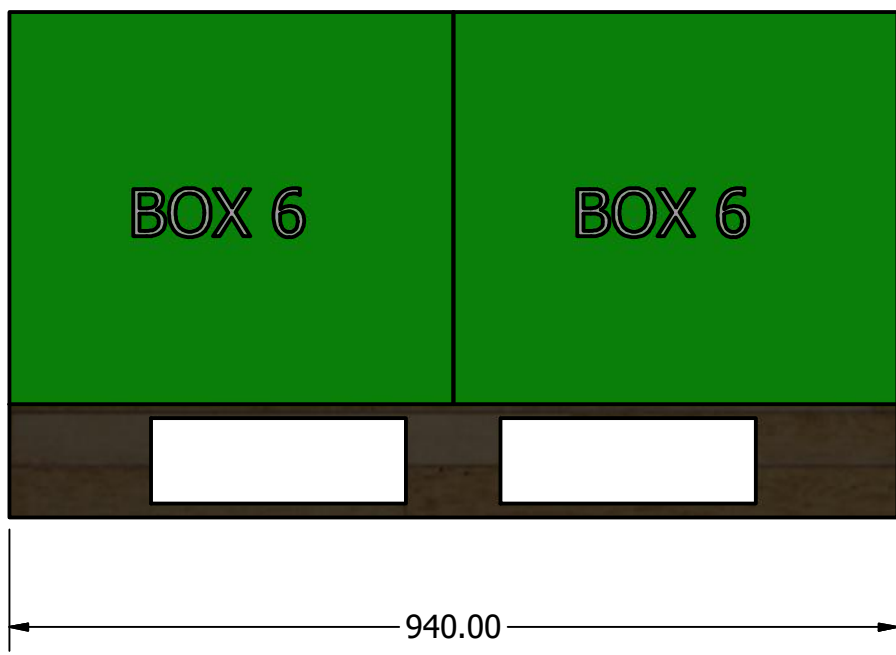
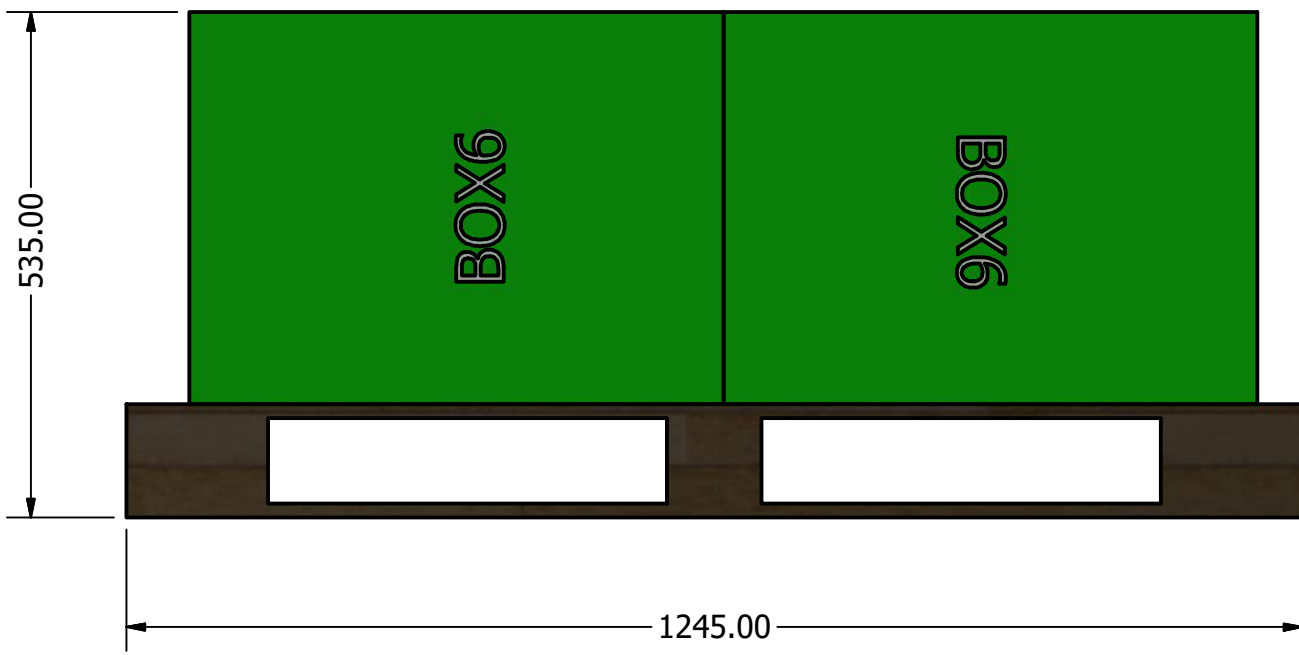
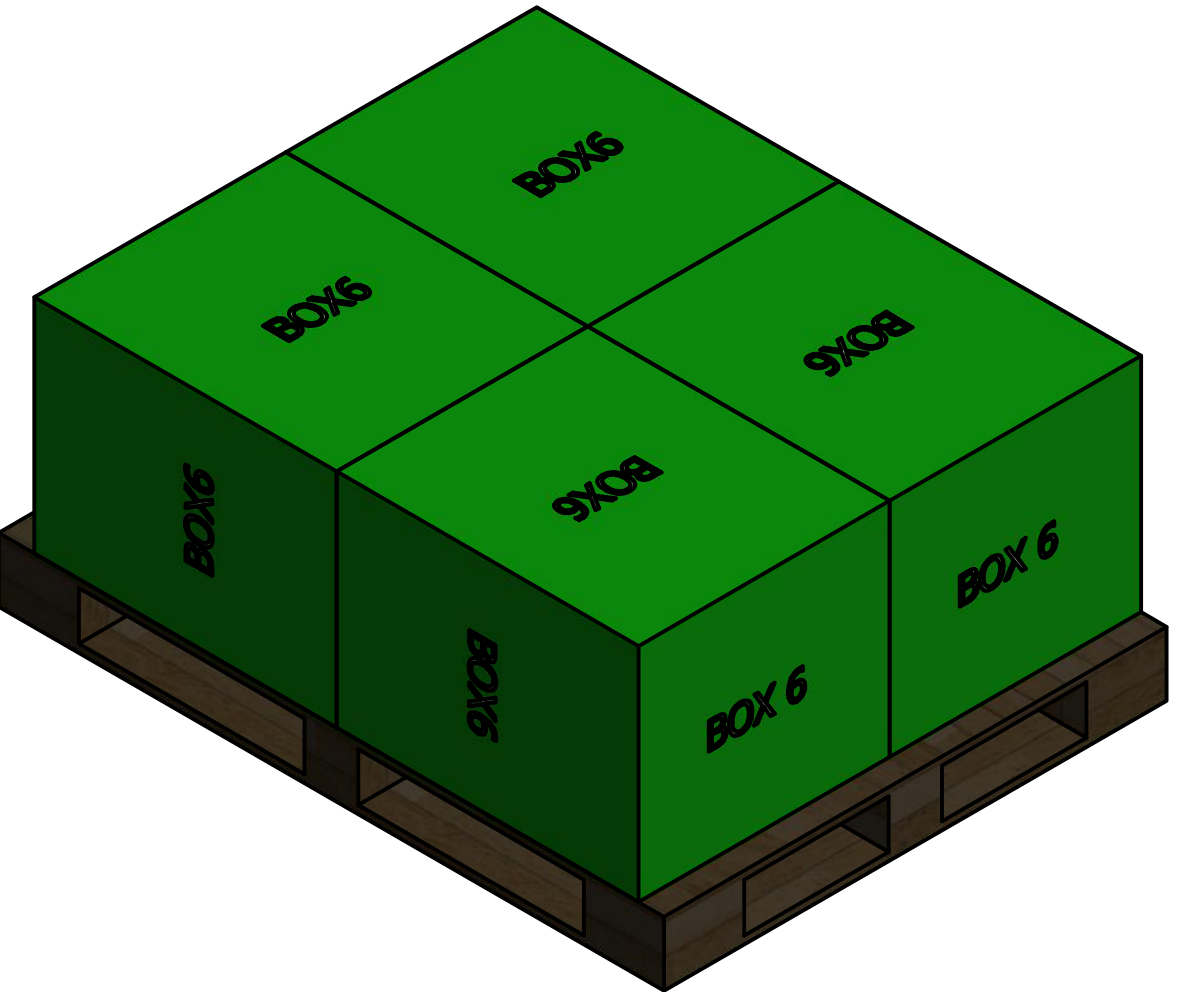
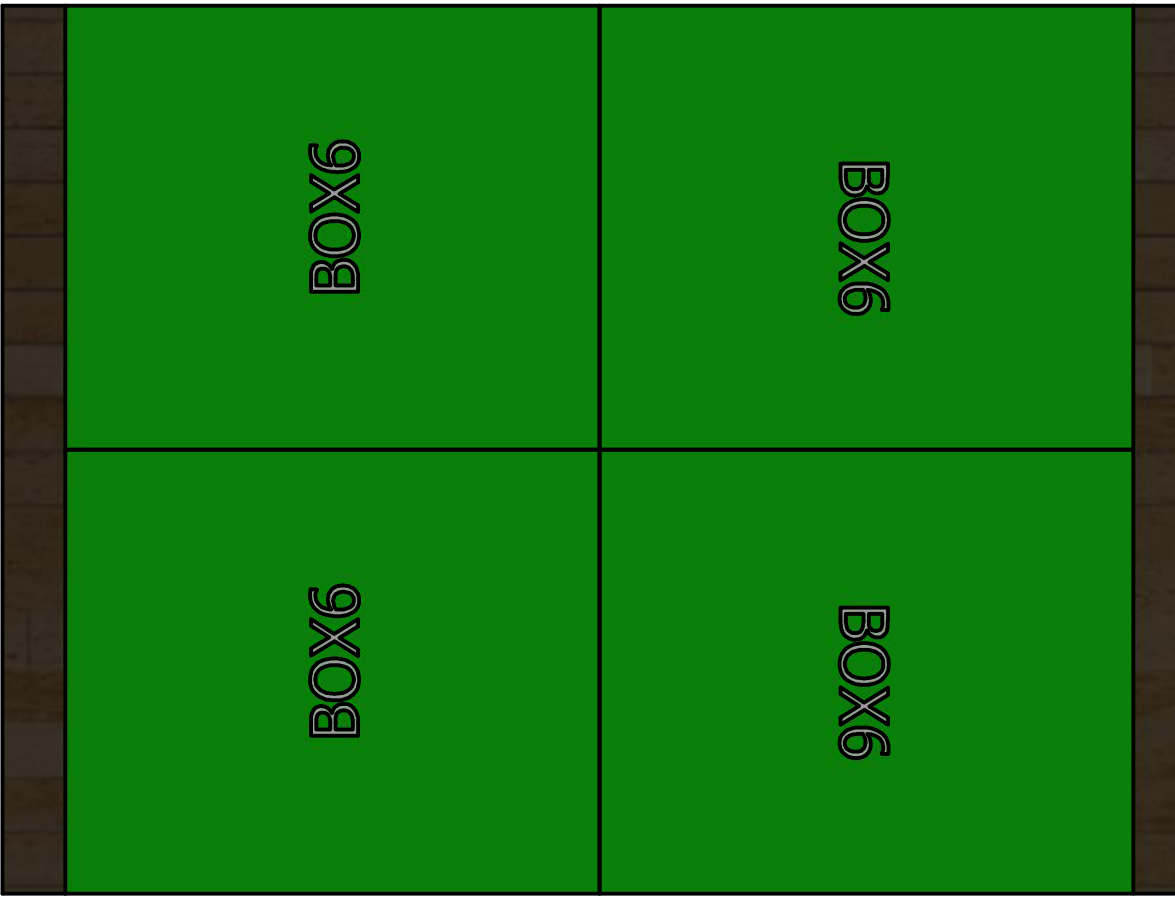

DRAWN				
CHECKED		TITLE		
QA				
MFG				
APPROVED				
		SIZE D	DWG NO	REV
		SCALE 1 : 8	SHEET 1 OF 1	

Pallet E (BOX6*12)

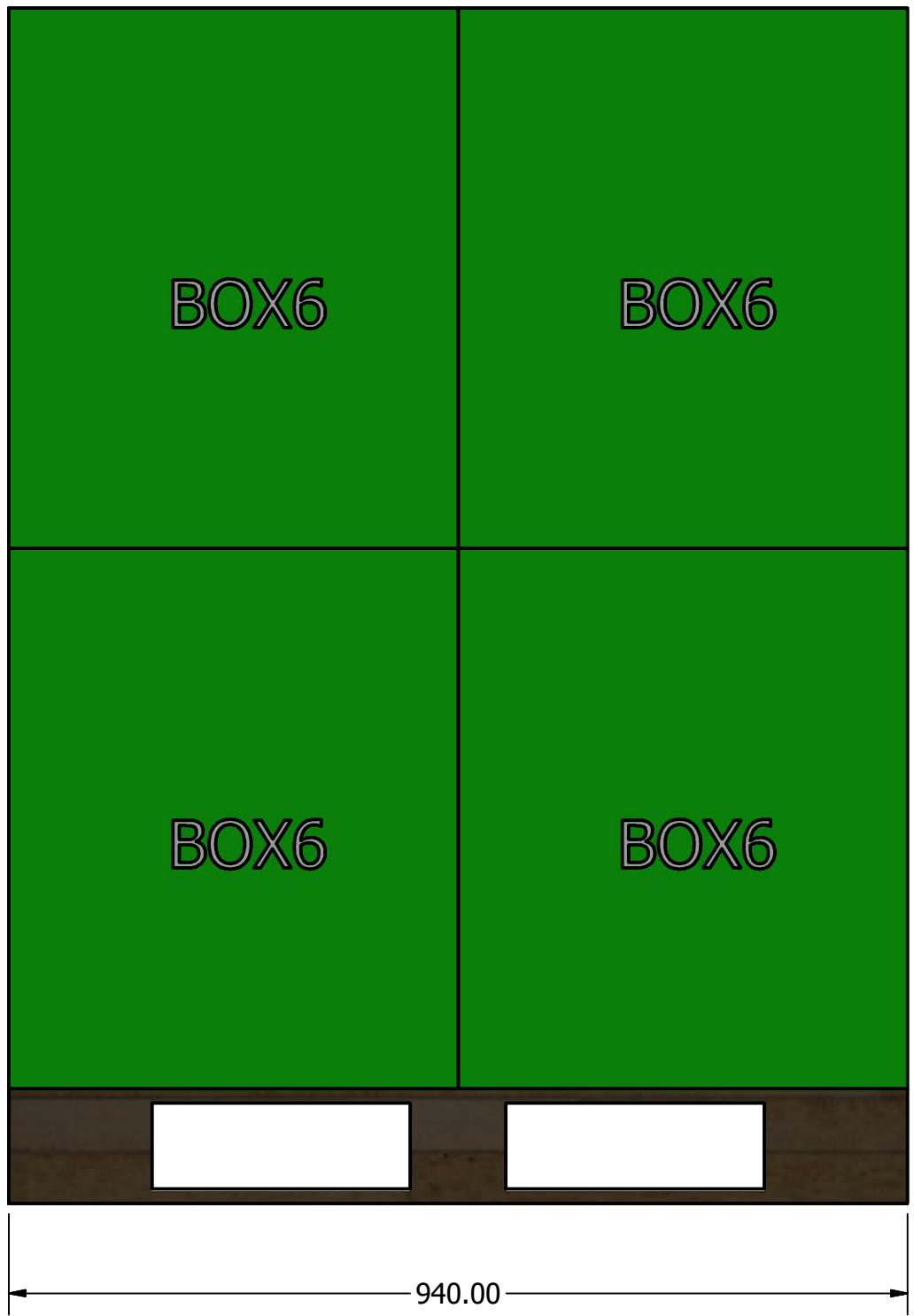
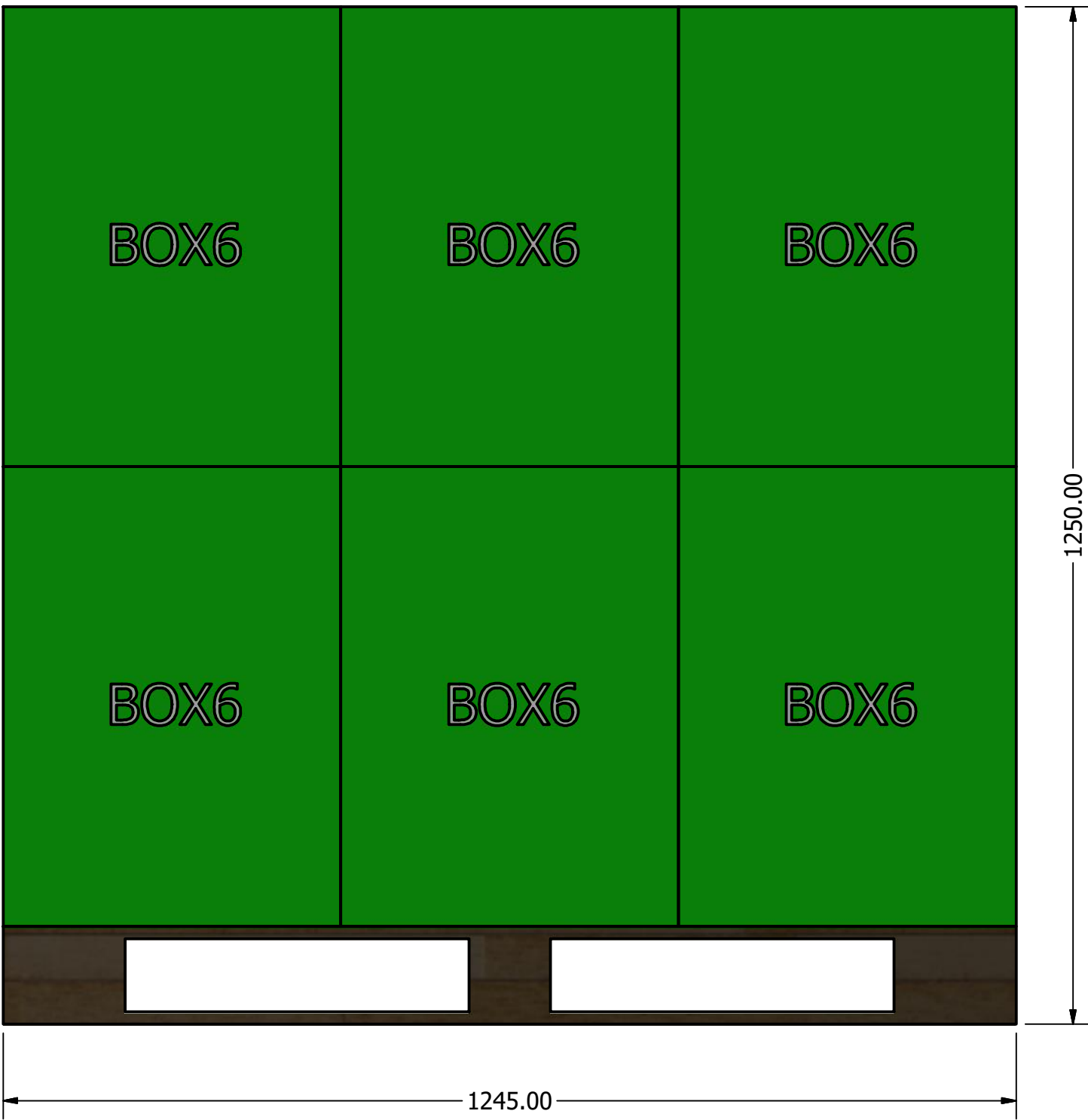
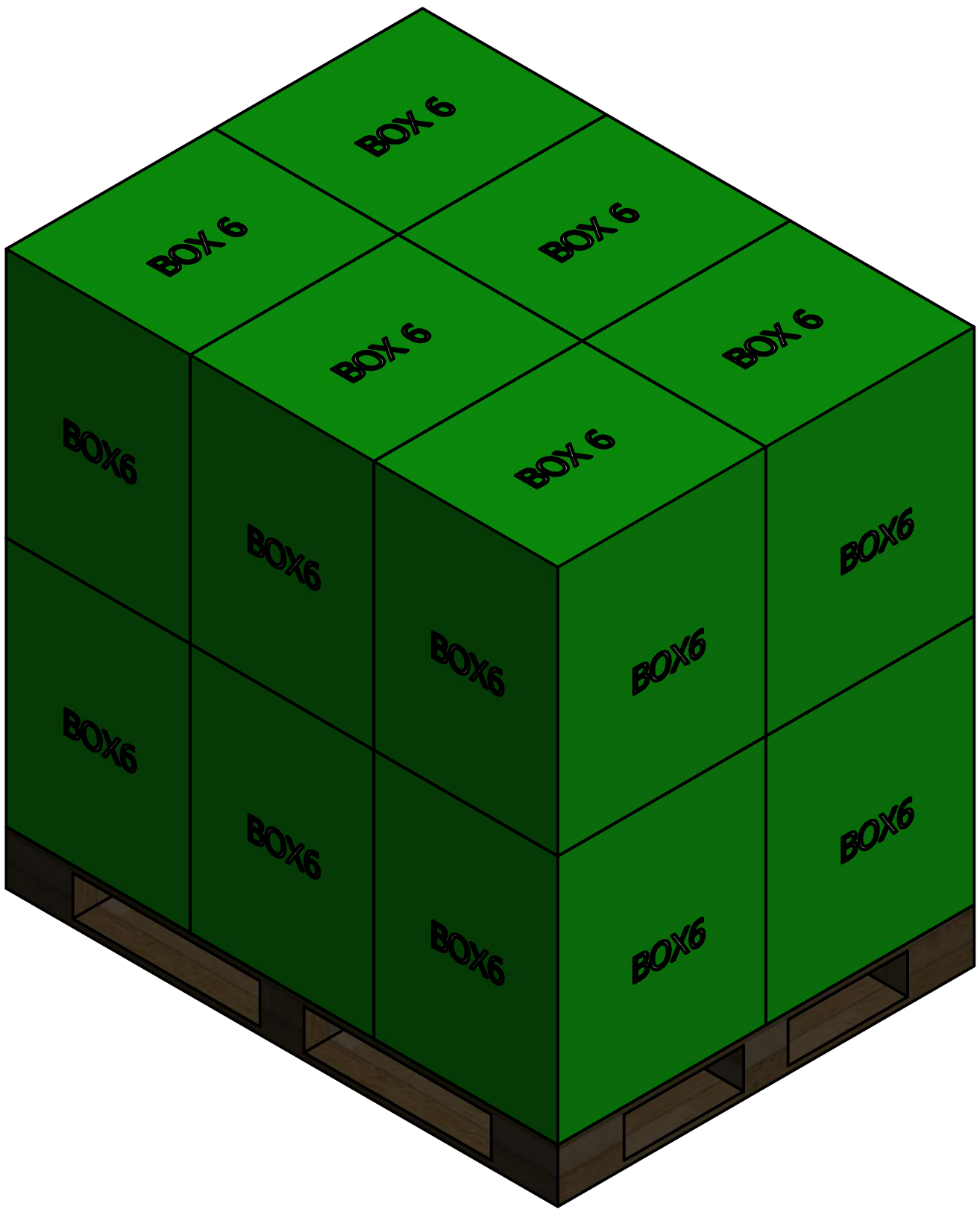
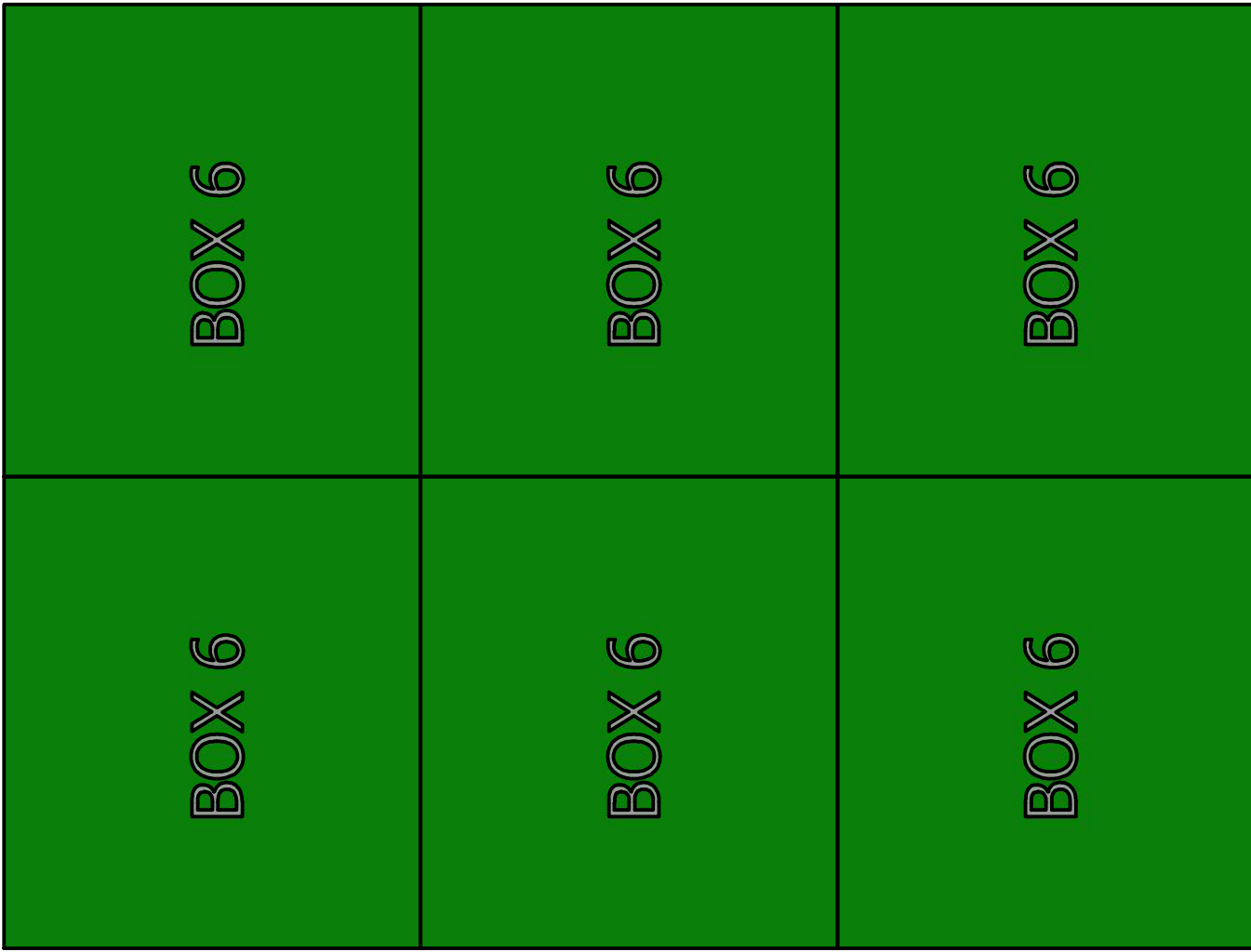

DRAWN		TITLE		
CHECKED		TITLE		
QA		TITLE		
MFG		TITLE		
APPROVED		TITLE		
		SIZE	DWG NO	REV
		D		
		SCALE	1 : 7	SHEET 1 OF 1

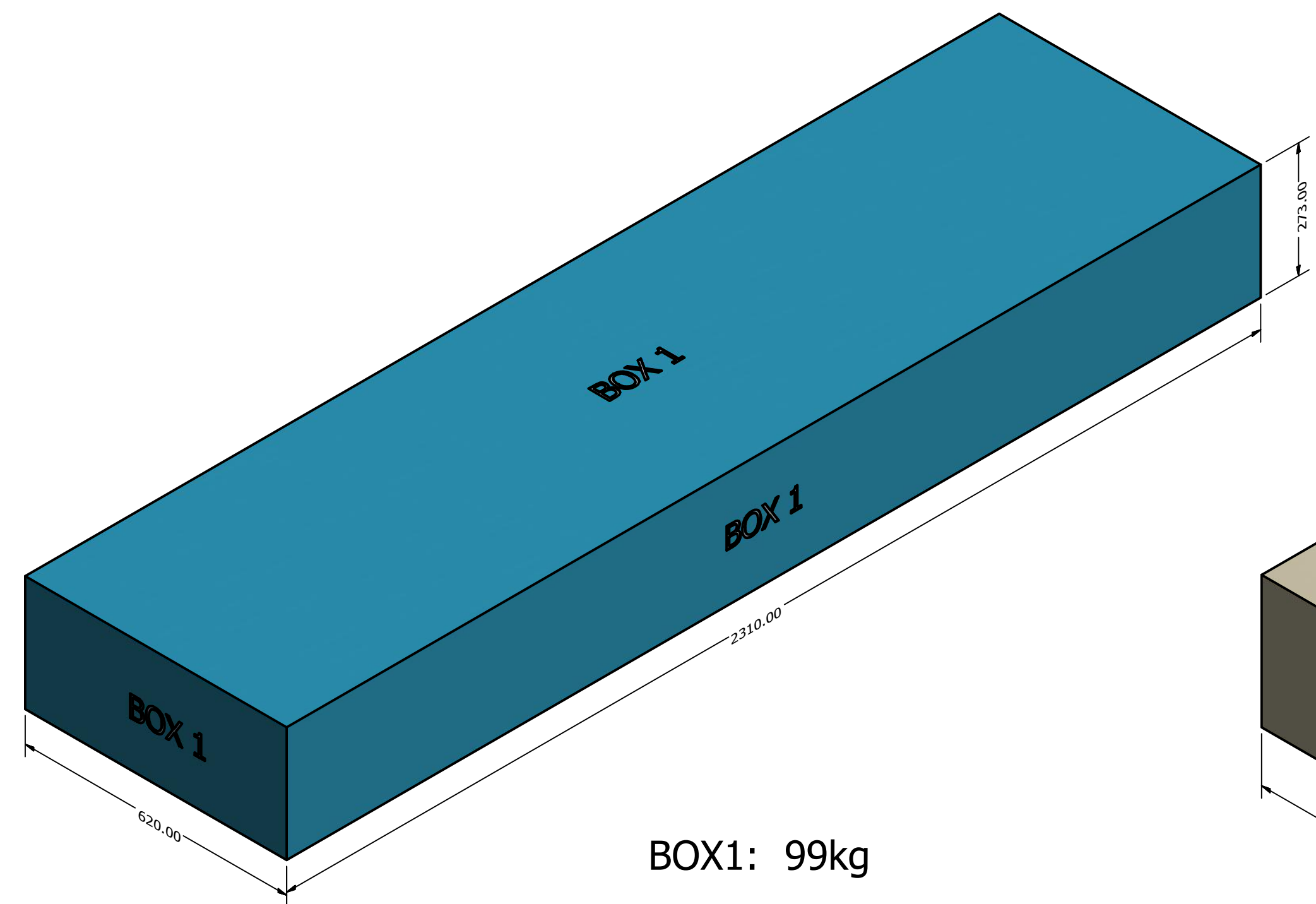

BOX1: 99kg

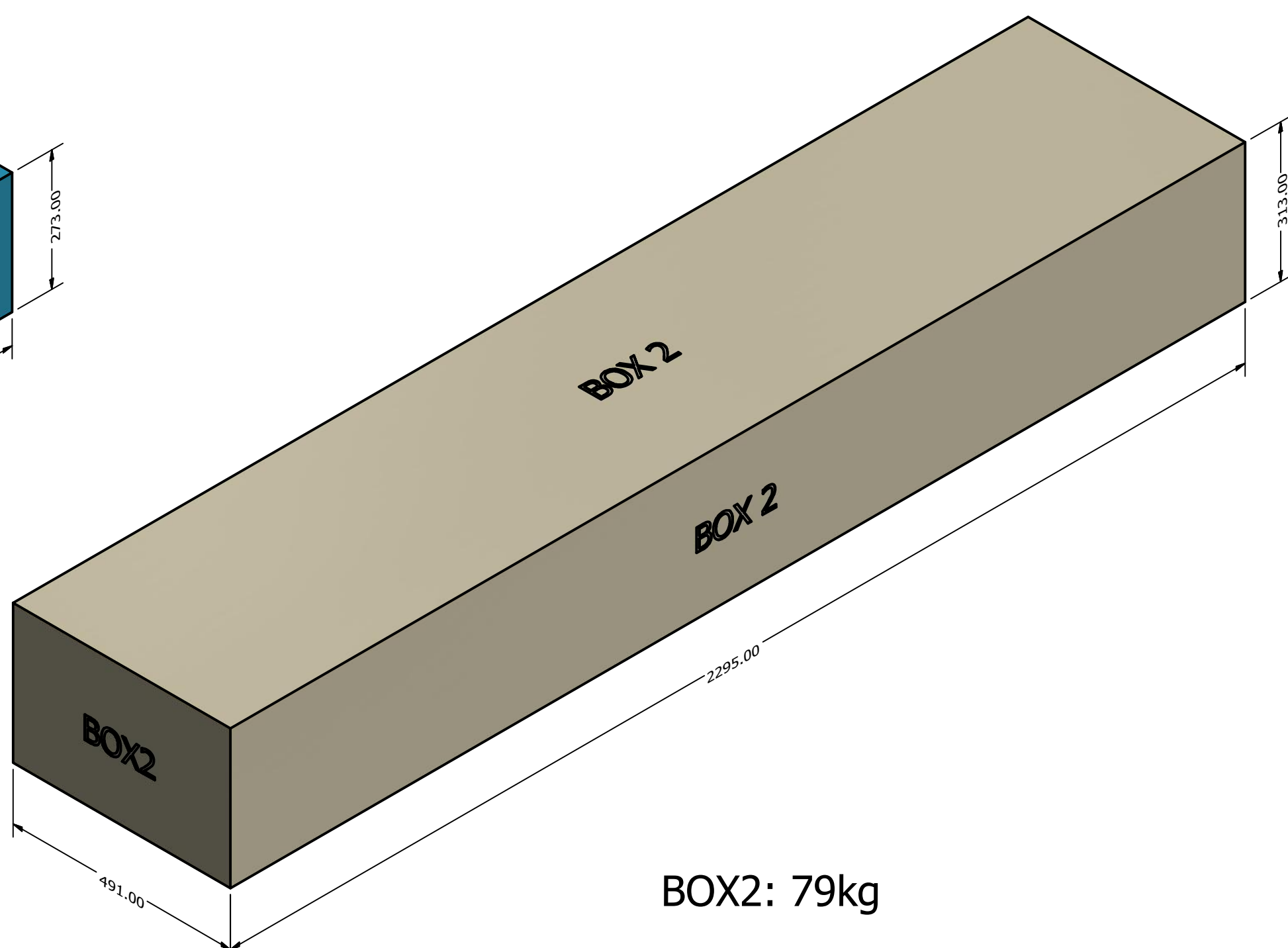

BOX2: 79kg

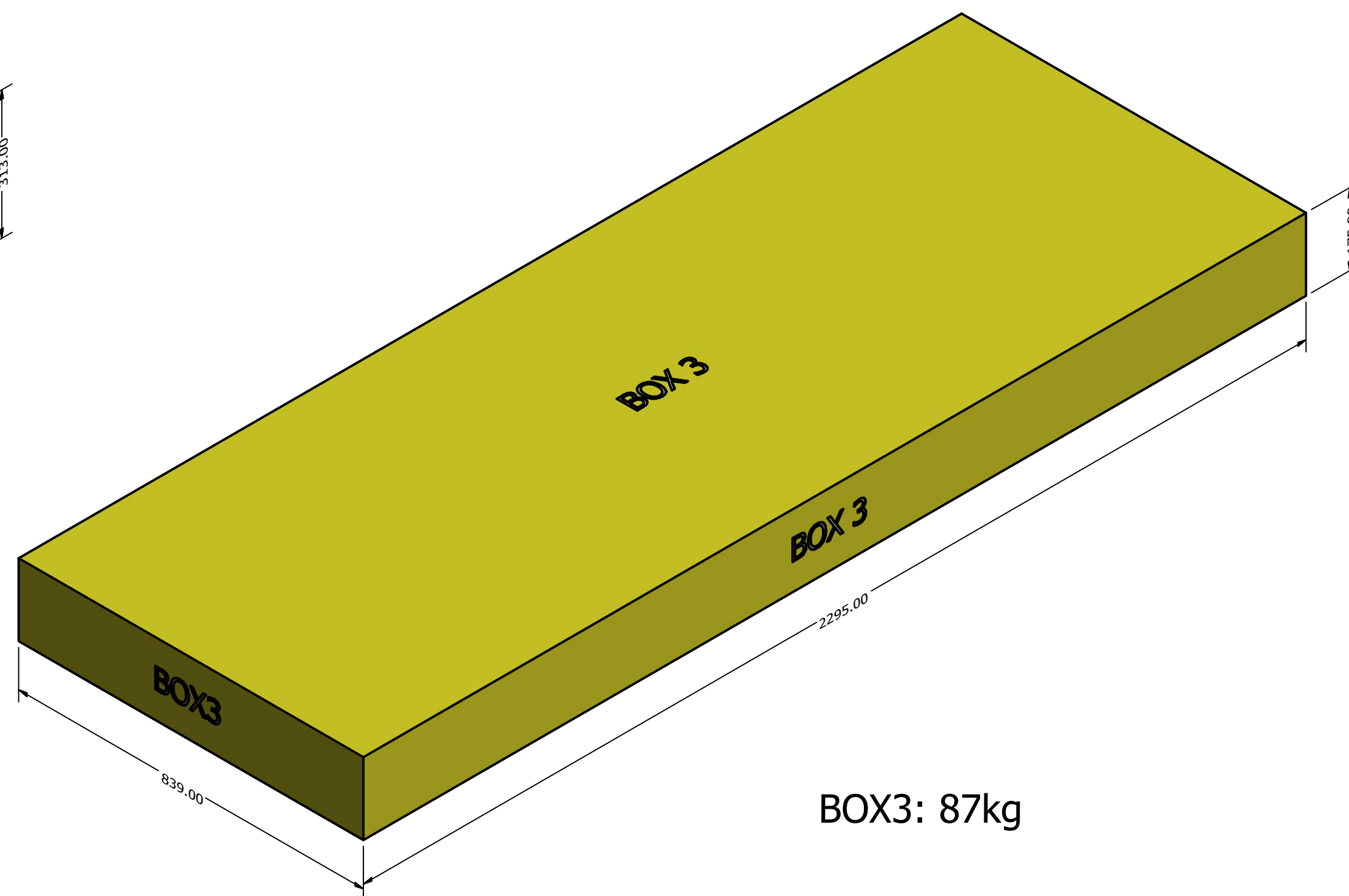

BOX3: 87kg

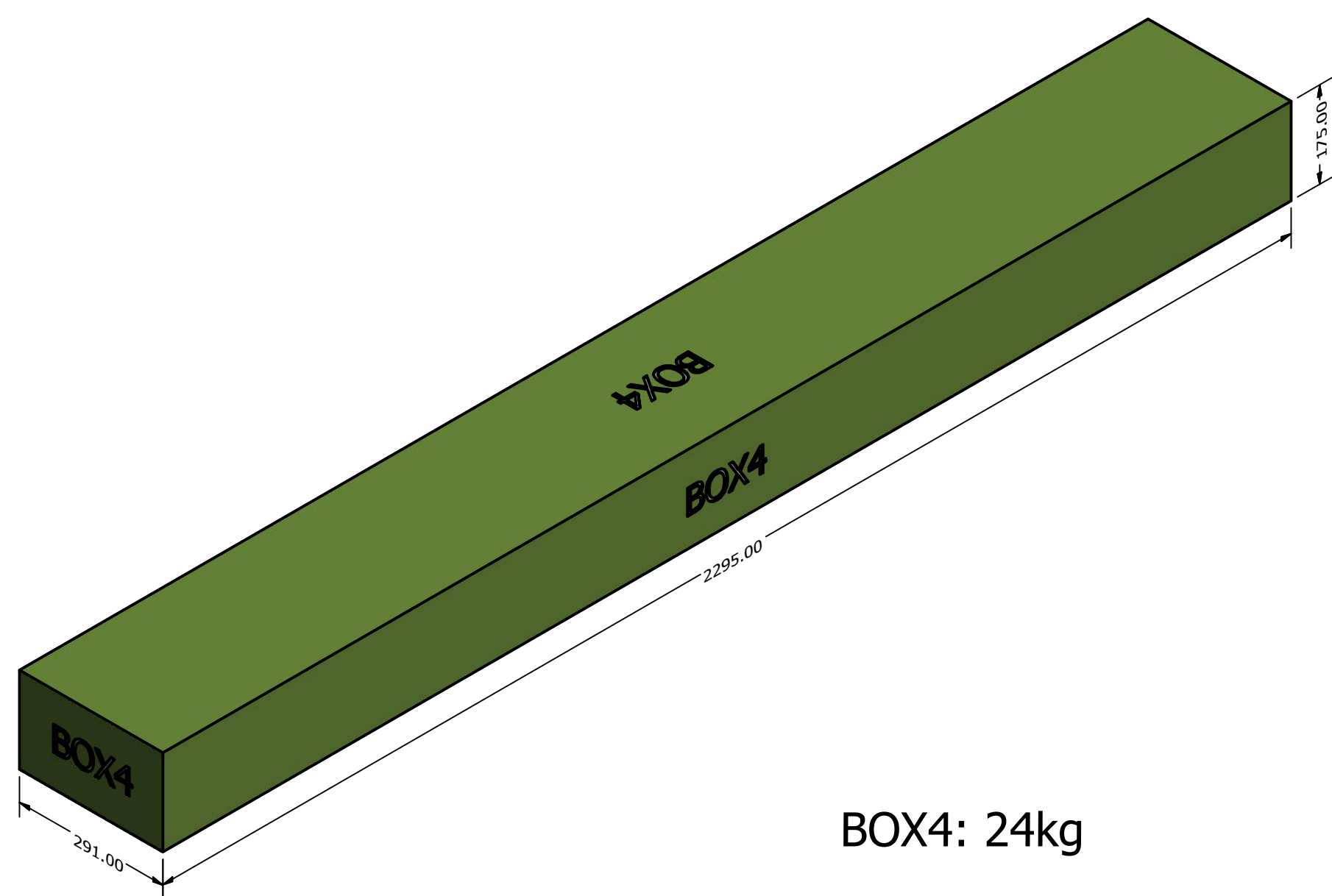

BOX4: 24kg

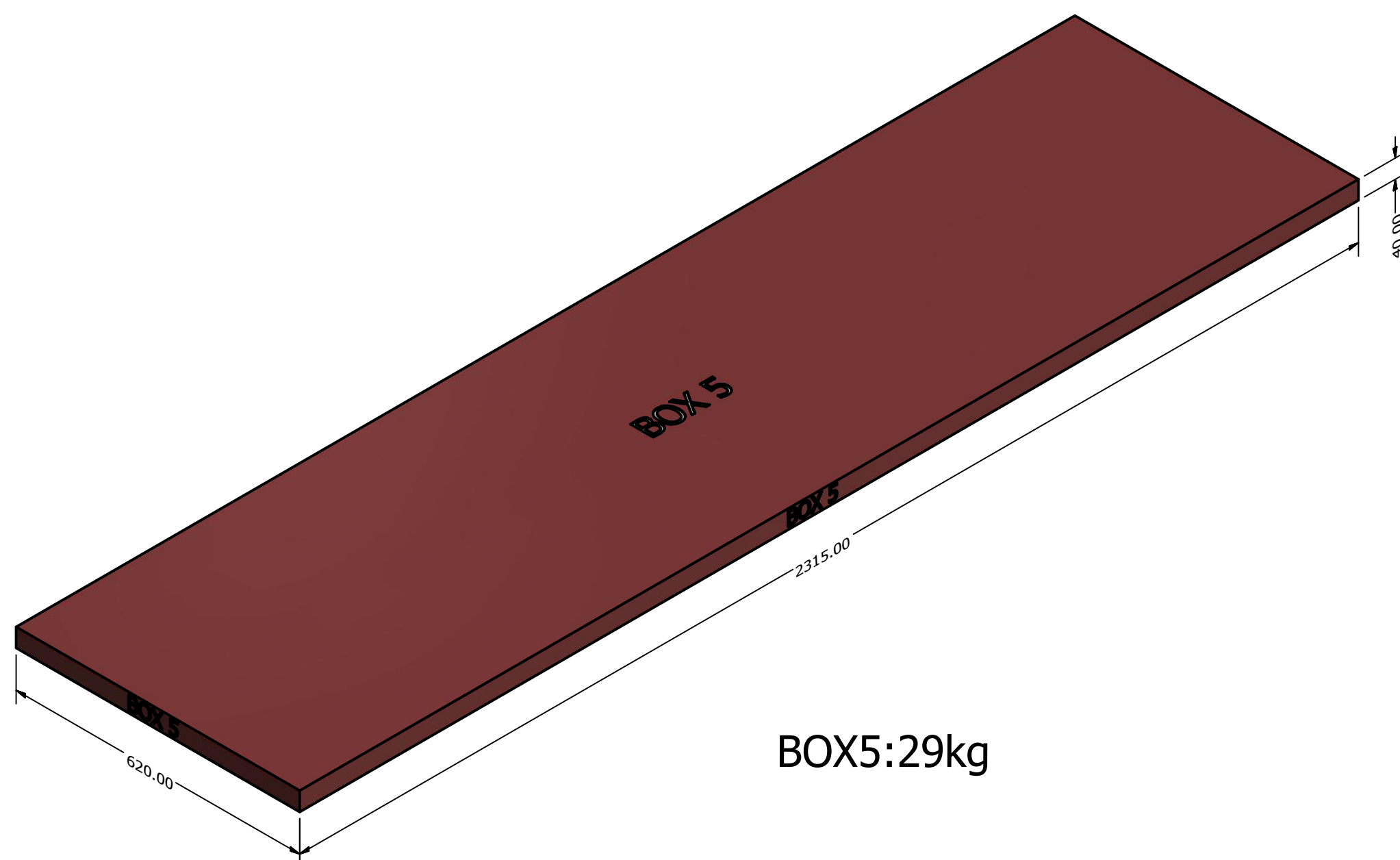

BOX5: 29kg

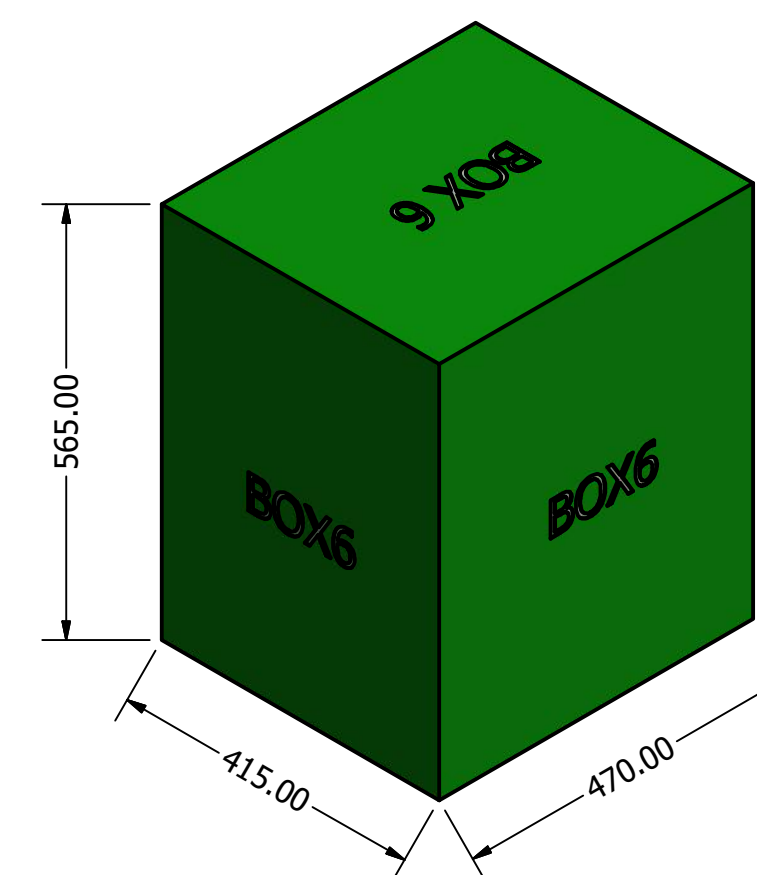

BOX6: 20kg

DRAWN		TITLE		
CHECKED				
QA				
MFG				
APPROVED		SIZE	DWG NO	REV
		D		
		SCALE	SHEET 1 OF 1	
		1 / 8		