

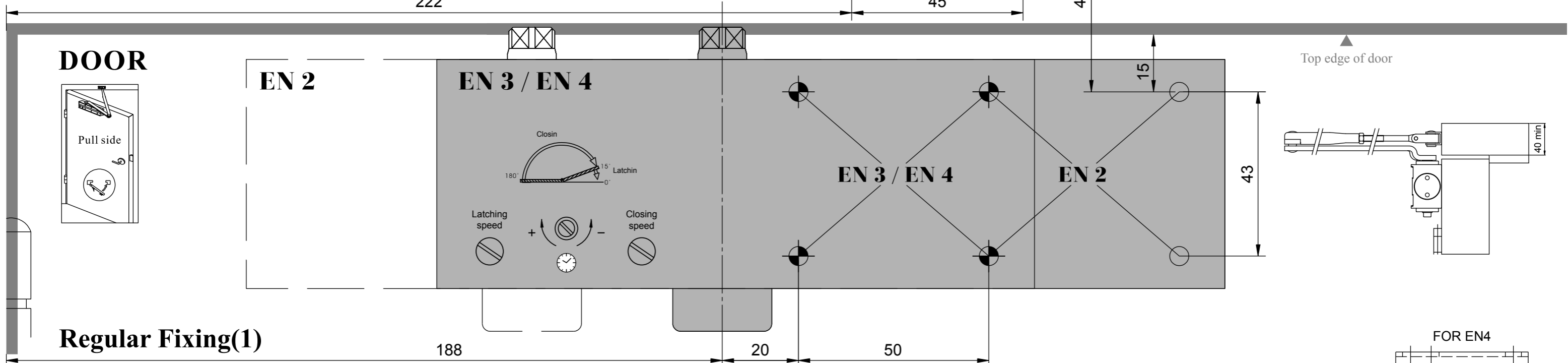

Power Selectable EN2~4 (BS EN1154:1997)



Regular Fixing(1)

Power size	Max. Door width	Max. Door weight	Max. Door opening
EN2	850mm	40Kg	180°
EN3	950mm	60Kg	180°
EN4	1100mm	80Kg	130°
4	1100mm	80Kg	180°

Ø drilling	
Ø2,5	Ø4,2
	
for wood door	for metal door

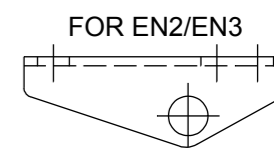
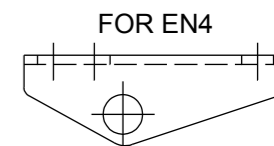
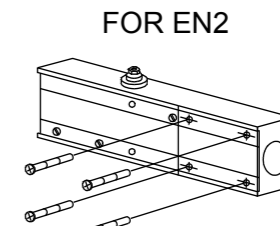
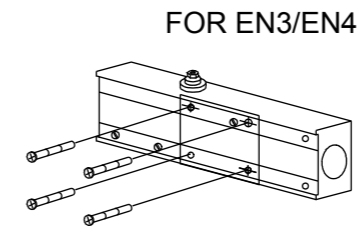

Fold Here

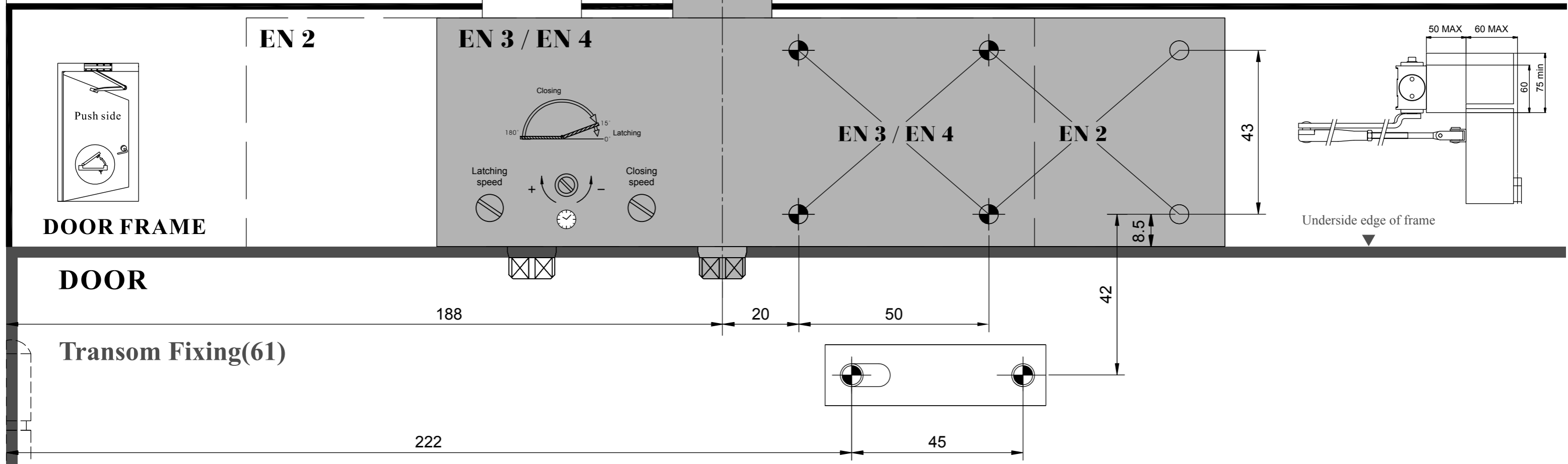

Transom Fixing(61)

DOOR FRAME

DOOR

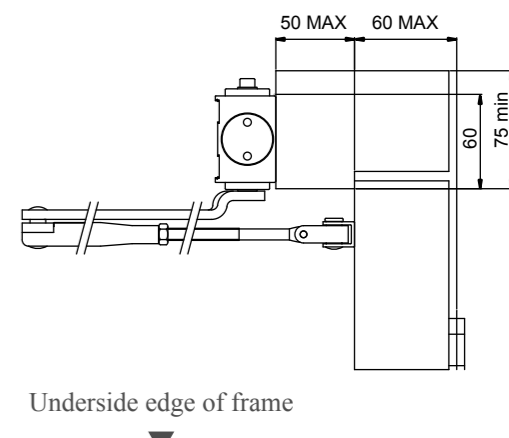

Power Selectable EN2~4 (BS EN1154:1997)

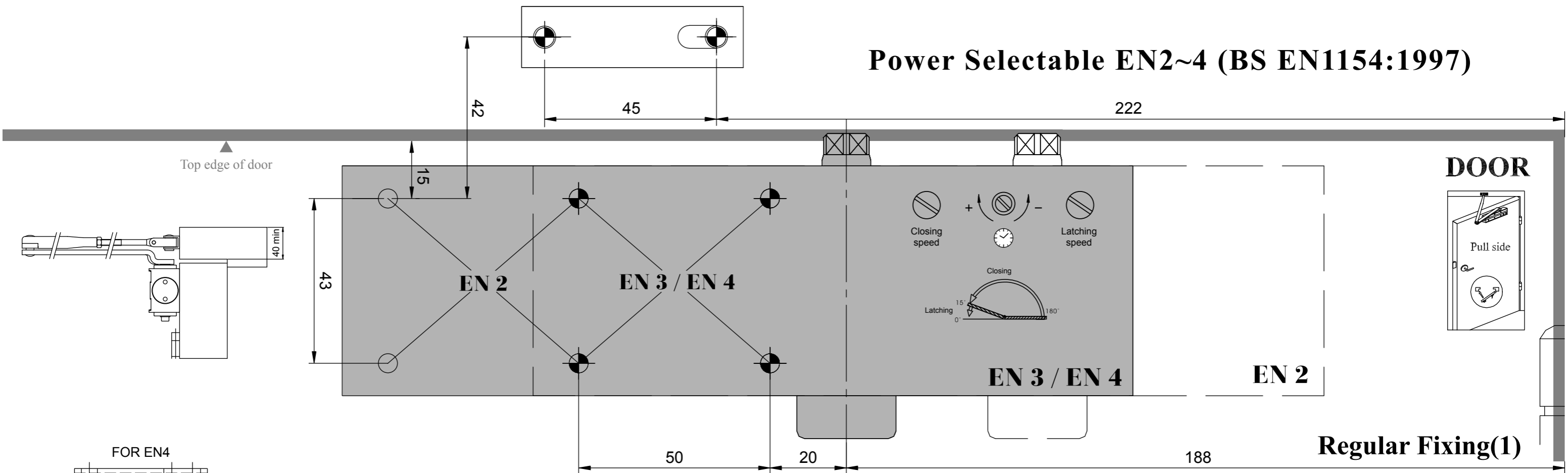

Regular Fixing(1)

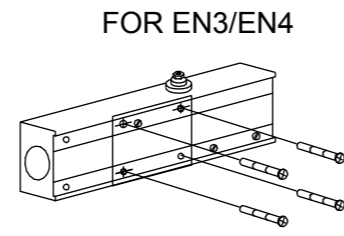
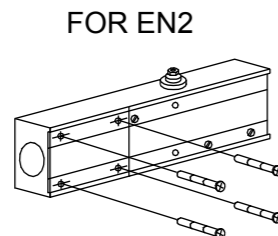
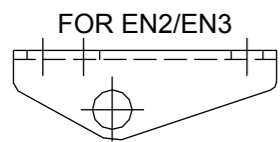
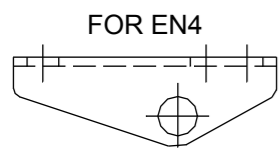

Ø drilling	
Ø2,5	Ø4,2
for wood door	for metal door

Power size	Max. Door width	Max. Door weight	Max. Door opening
EN2	850mm	40Kg	180°
EN3	950mm	60Kg	180°
EN4	1100mm	80Kg	130°
4	1100mm	80Kg	180°

Fold Here

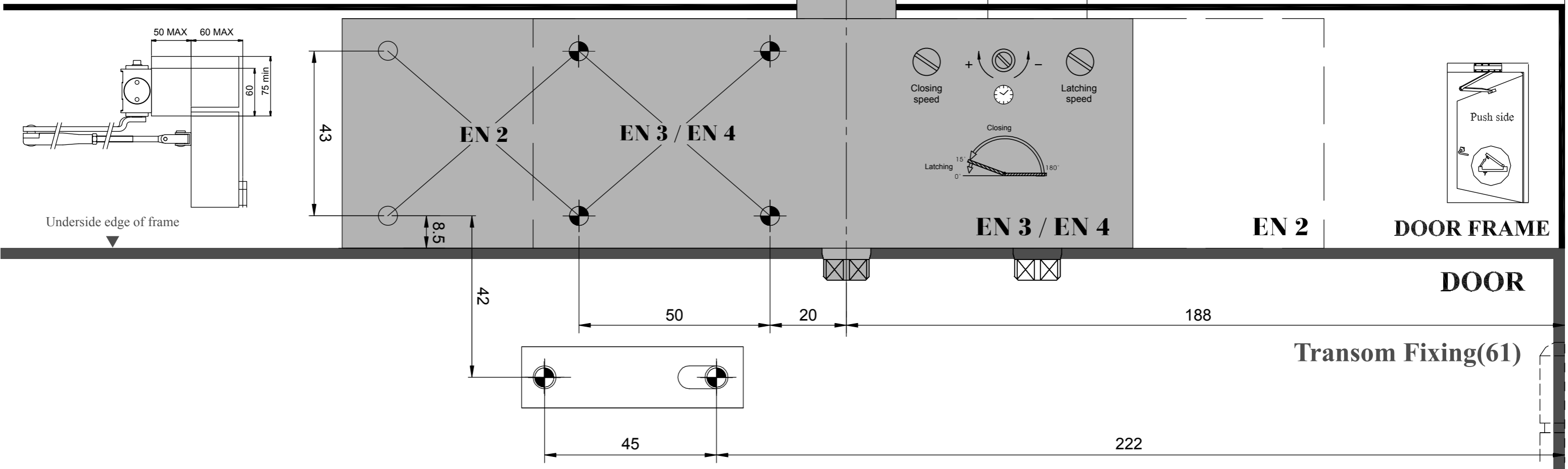

Transom Fixing(61)