

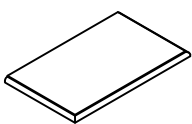

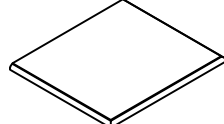

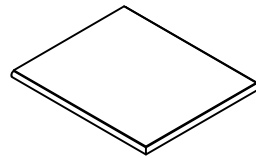

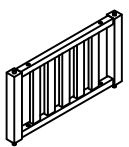

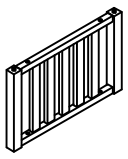

# ASSEMBLY INSTRUCTION

## E334-04(3A) END TABLE

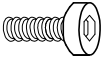
<b>A</b> Table Top  1 pc	<b>B</b> Shelf  1 pc	<b>C</b> Bottom  1 pc	<b>D</b> Up Back  1 pc
<b>E</b> Down Back  1 pc	<b>F</b> Up Left Post  1 pc	<b>G</b> Up Right Post  1 pc	<b>H</b> Down Left Post  1 pc
<b>I</b> Down Right Post  1 pc	<b>J</b> Allen Bolt $\text{\O}1/4" \times 50\text{mm}$  2 pcs	<b>K</b> Allen Bolt $\text{\O}1/4" \times 32\text{mm}$  8 pcs	<b>L</b> Allen Bolt $\text{\O}1/4" \times 15\text{mm}$  8 pcs
<b>M</b> Lock Washer $\text{\O}1/4"$  18 pcs	<b>N</b> Flat Washer $\text{\O}1/4" \times 19 \times 1.5\text{mm}$  18 pcs	<b>O</b> Allen Key 4mm  1 pc	<b>P</b> Angle Iron $30 \times 18 \times 20\text{mm}$  4 pcs

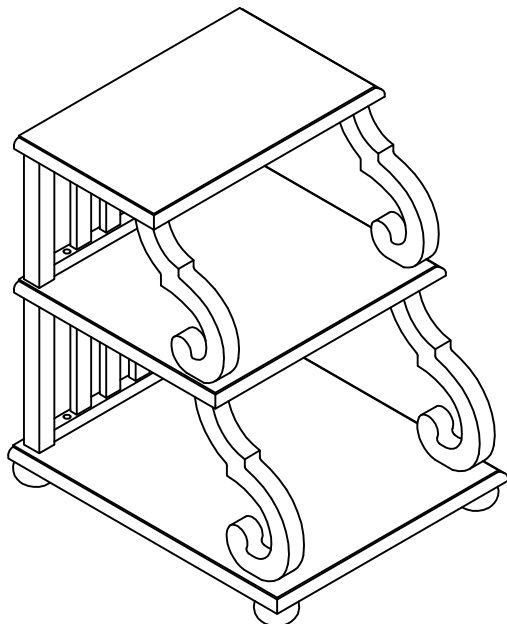

This page lists all the contents included in the box. Please take the time to identify the hardware as well as the individual components to this product. As you unpack and prepare for assembly, place the contents on a carpeted or padded area to protect them from damage.

- 1** Attached Up Back(D) to the Table Top(A). Use Allen Bolt(K) Lock Washer(M) and Flat Washer(N) on holes of Up Back(D). Attached Up Post(F & G) to the Table Top(A). Use Allen Bolt(L) Lock Washer(M) and Flat Washer(N) on holes of Angle Iron(P). Turn the Allen Key(O) in Allen Bolt(L).

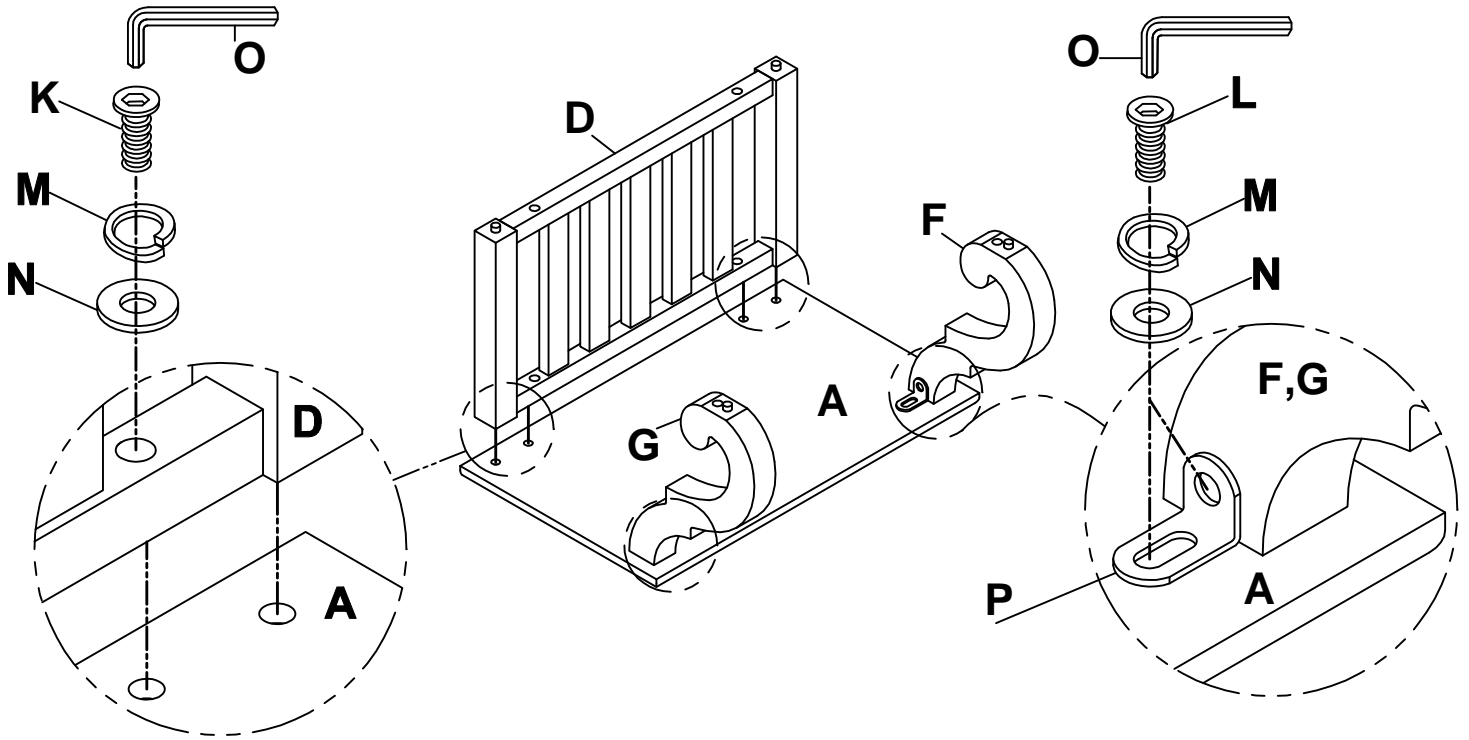

- 2** Attached Shelf(B) to the Up Back(D). Use Allen Bolt(J) Lock Washer(M) and Flat Washer(N) on holes of Down Back(E), and through holes of Shelf(B). Attached Shelf(B) to the Up Post(F & G). Use Allen Bolt(K) Lock Washer(M) and Flat Washer(N) on holes of Shelf(B). Turn the Allen Key(O) in Allen Bolt(J).

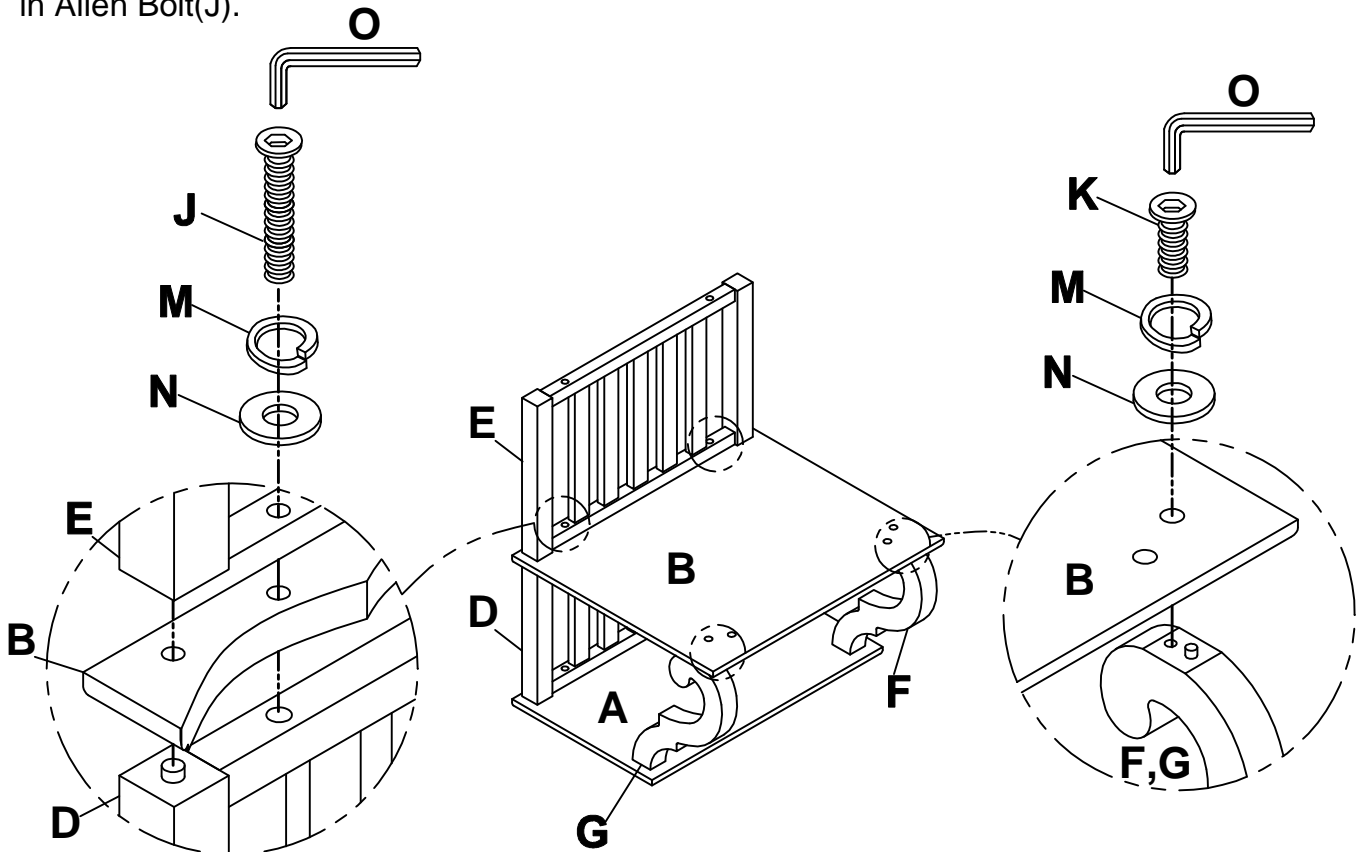

**3** Attached Down Post(H & I) to the Shelf(E). Use Allen Bolt(L) Lock Washer(M) and Flat Washer(N) on holes of Angle Iron(P). Turn the Allen Key(O) in Allen Bolt(L).

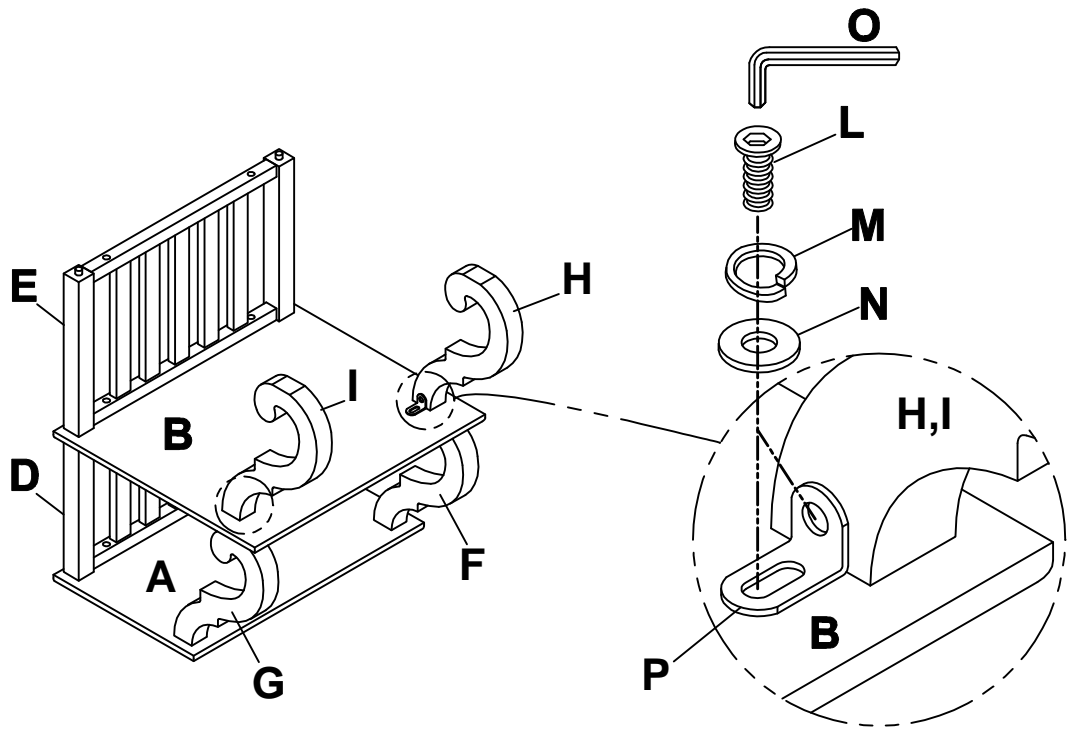

**4** Attached Bottom(C) to the Down Back(E) and Down Post(H & I). Use Allen Bolt(K) Lock Washer(M) and Flat Washer(N) on holes of Bottom(C). Turn the Allen Key(O) in Allen Bolt(K).

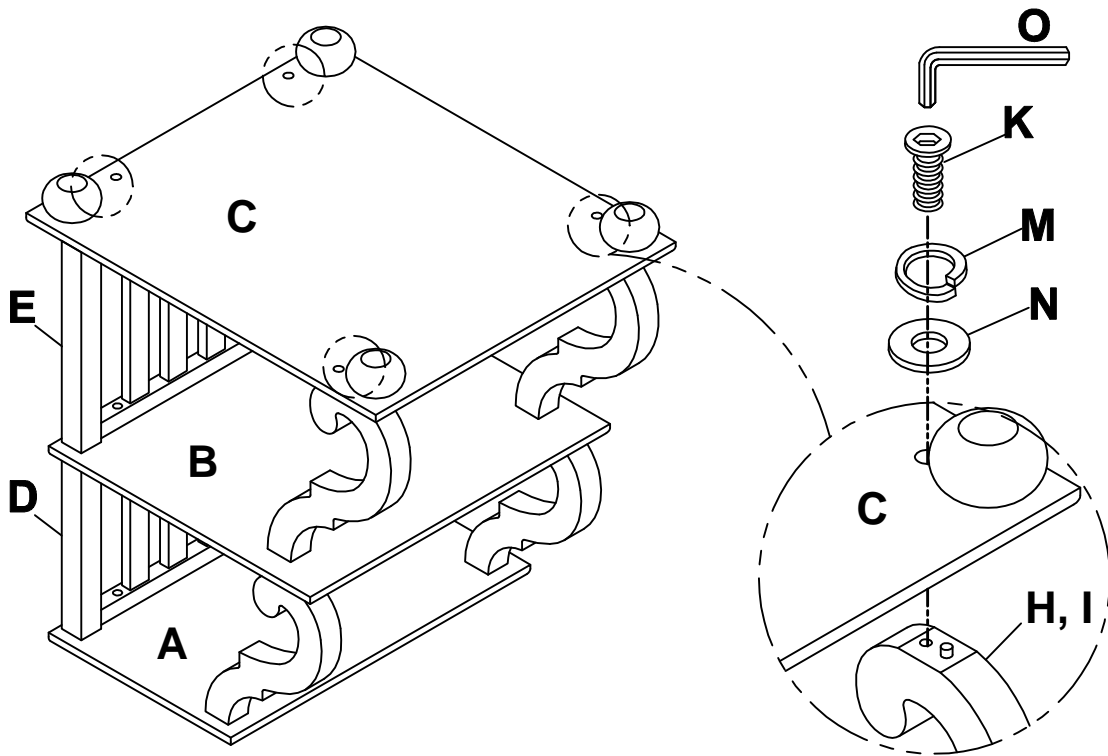

### Cleaning & Care

Treat surface with care. Surface is resistant to scratches but is not scratch resistant. Clean surfaces with a dry or damp soft cloth. Do not use abrasive cleaners. Hardware may loosen over time. Periodically check that all connections are tight.