



Send Us a Text: 1-812-652-2525
(US and Canada Only. Carrier Fees May Apply)



Find Us Online: www.maxicosi.com
Email Us: support@djgusa.com



Give Us a Call: 1-800-951-4113
(Toll Free, US and Canada Only)

Replacement Parts List

(on select models)

Seat Pad Set
Lower Anchor Belt
Locking Clip
Base
Instructions

For parts availability and questions, call, text, or chat.
If requested color is not available, similar color will be substituted.
Applicable tax and shipping & handling will also be added.

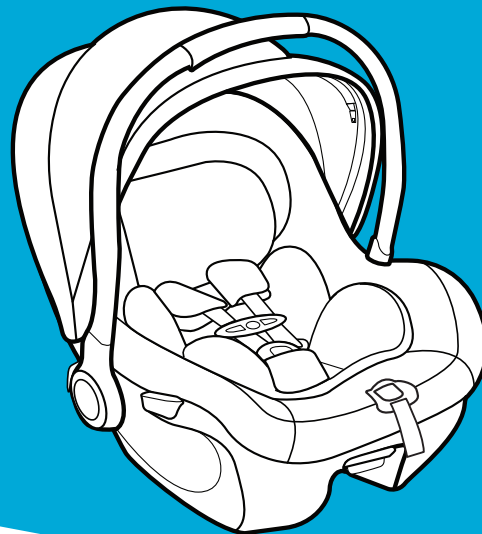

Peri™ 180

Rotating Infant Car Seat

Your model may look different than one shown on cover.

Read all instructions BEFORE USING this child restraint.

KEEP INSTRUCTIONS FOR FUTURE USE.

⚠ Failure to follow the warnings on the labels and in the instruction manual can result in serious injury or death to your child. Serious injury may include paralysis and/or permanent brain injury.

4358-8450B 12.8.23

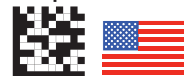

Welcome to the Maxi-Cosi Family!

Thank you for choosing this car seat, also known as a child restraint!

To help you get started using your child's new car seat, here are the 4 main tasks you'll need to complete.

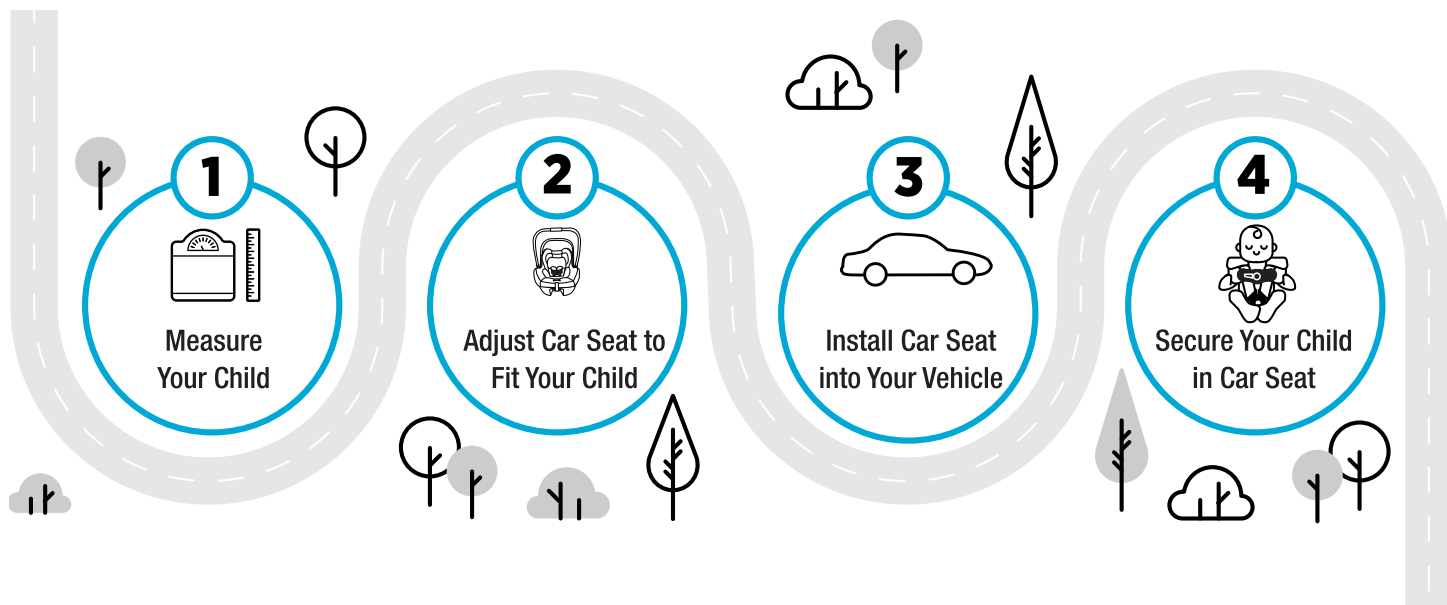

**SCAN HERE
FOR INSTALL
VIDEOS**



Your child's safety is worth the time it will take to read and follow these instructions.

Ready? Let's go!

Pages 1-4 will introduce you to the parts of the car seat.

The Back Cover of this Manual has our contact information.

If at any point you would like assistance, please feel free to reach out to us.

Contents

1 Getting Started

- 1 Parts of Car Seat
- 3 Accessory Use
- 4 [Rear-Facing Requirements](#)
- 5 Installing Base with Vehicle Belt
- 10 Installing Base with LATCH: Lower Anchor Belt
- 15 Rotating & Reclining Car Seat on Base
- 17 Load Leg
- 19 Removing & Installing Car Seat to Base

21 [Rear-Facing Section](#)

- 23 [Rear-Facing Child Fit](#)
- 28 [Vehicle Install without Base](#)
- 33 [Securing Child in Car Seat](#)

37 Making Adjustments to Car Seat

- 37 Changing Headrest/Harness Height
- 38 Changing Buckle Position
- 41 Harness System Adjustments for Smaller Infants
- 43 Carrier Use
- 44 Canopy Use

46 Wash & Care

- 46 Removing Seat Pad Set
- 48 Cleaning Parts of Car Seat & Installing Seat Pad Set

49 LATCH & Vehicle Belt Information

- 49 LATCH: Lower Anchor Belt
- 51 Vehicle Belts

55 Safety Information

- 55 Child Restraint Use
- 56 Vehicle Seating Position
- 57 Installation in Vehicle
- 58 Replacement & Expiration
- 59 Registration & Safety Notices
- 60 Aircraft Information

61 Warranty

©2023 Dorel Juvenile Group, Inc. (800) 951-4113 www.maxicosi.com. Styles, colors, and labeling may vary. Les styles, les couleurs et l'étiquetage peuvent varier. Made in China. Fabriqué en CHINE. Hecho en CHINA. Distributed by (distribué par) Dorel Juvenile Group, Inc., 2525 State St., Columbus, IN 47201-7494. Dorel Juvenile Canada, 2233 Argenta Road, Suite 110, Mississauga, ON L5N 2X7. Representante exclusivo en Chile: DOREL JUVENILE CHILE S.A. Av. del Parque 4161, oficina 602 A, Huechuraba, Santiago, Chile - Fono: 56 2 24971500 - www.infanti.cl - www.dorel.cl. Importado y distribuido en Perú por: COMEXA COMERCIALIZADORA EXTRANJERA S.A. SUCURSAL DEL PERÚ - Los Libertadores 455, San Isidro, Lima 27, Lima, Perú RUC 20431062870 - Fono: 4413029 - www.infanti.com.pe. En Centro América, Caribe y Ecuador por: Best Brands Group S.A. - Av. Balboa, Bay Mall Plaza, Planta Baja, local 9, Panamá. - Fono: (507) 300 2884. En Colombia por: Baby Universe S.A.S. - Via 40 No. 77-29, Barranquilla, Colombia - Fono: (575) 353 1110 Importador: DJGM, S.A. DE C.V. Gabriel Mancera No. 1041 Col. Del Valle, Benito Juárez C.P. 03100 México, Ciudad de México R.F.C. DJG140305GN9 Tel. (55) 67199202



Parts of Car Seat

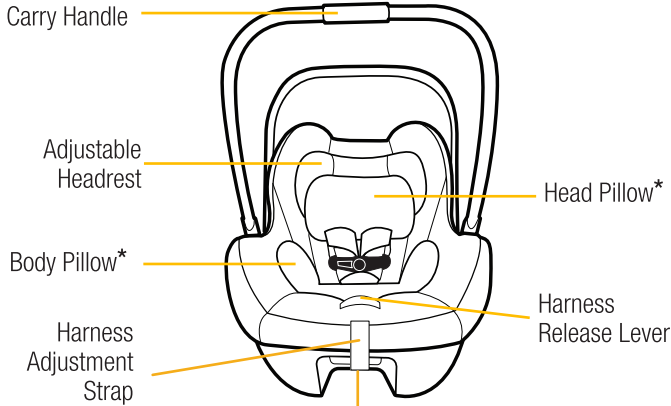

Car Seat Release Handle
(Underneath front of car seat)

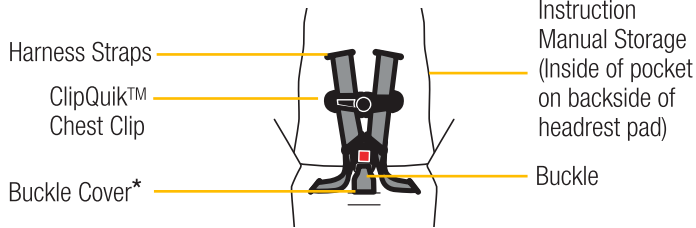
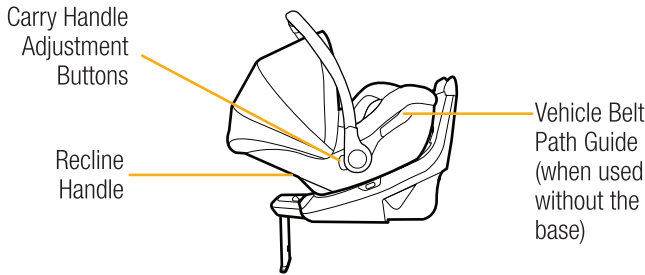

Your model may look different than one shown.

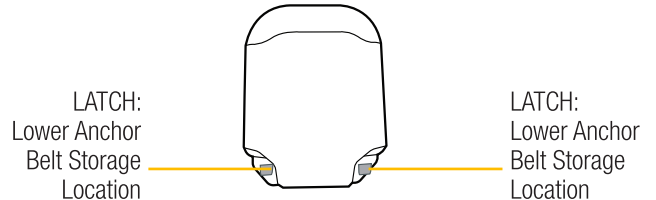
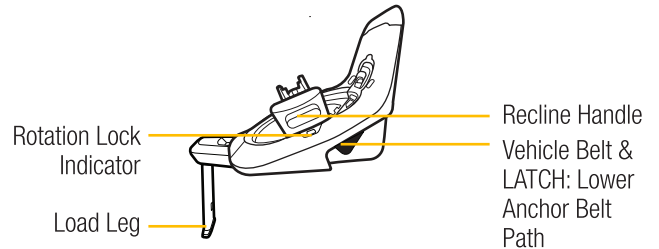
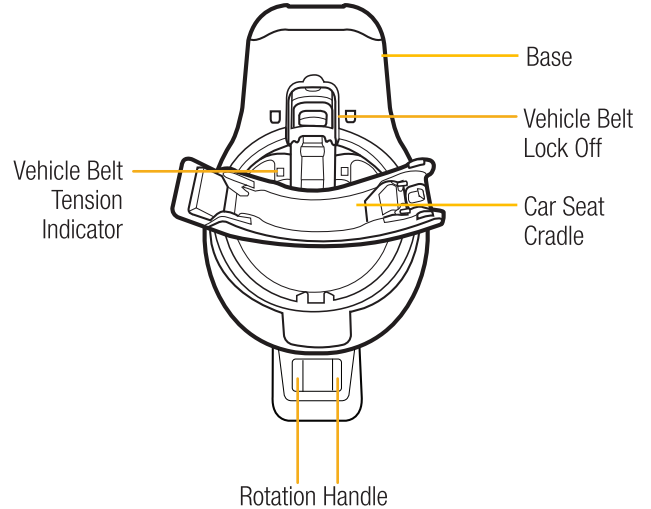

*See pages 3-4 for Accessory Use.



Head Pillow (on select models)

To remove head pillow, from the back of the head pillow gently pull the fabric tabs out of from around the harness straps.



Buckle Cover (on select models)

To remove, undo the buckle and pull the buckle cover off the buckle.



Body pillow (on select models)

To remove, undo the buckle and pull it through the slot in the pillow. Slide the pillow out from behind the harness straps



Harness Covers (on select models)

The harness covers help provide comfort to your child's neck.

To remove, undo the harness, pull the fastening strips apart

and pull the harness covers off of the top part of the harness cover. The bottom part is not removable.

⚠️ WARNING:

Failure to follow these instructions may result in serious injury or death to your child. Serious injury can include paralysis and/or permanent brain injury.

Be certain to measure your child's weight and height (do not guess) before using this car seat.

This car seat can only be used **REAR-FACING**.

Your child's height, weight, and age determine how the car seat should be placed in the vehicle. Children vary widely in body size, shape, and temperament—**please consult your doctor before switching between any modes within the limits and fit requirements of the car seat.**

Infants and Toddlers

Must use the seat in rear-facing mode as long as possible, which is until the child reaches the maximum weight or height limit for rear-facing mode.

Toddlers and Preschoolers

Once they are facing forward, the child must use the seat in forward-facing mode with a harness for as long as possible, which is until the child reaches the maximum weight or height limit for forward-facing mode.

School-Aged Children

Once they have outgrown their forward facing car seat, the child must use a belt-positioning booster seat until the vehicle's lap and shoulder seat belt fit properly.

If you have any questions regarding the proper mode for your child, please see the back cover of this manual for our contact information.

REAR-FACING

**4-30 lb (1.8-13.6 kg) and
32 in. (81.3 cm) or less in height**

Children under 1 year of age **MUST** ride Rear-Facing.

This car seat can only be used Rear-Facing.

- **Rear-Facing Child Fit** requirements, see page 23



Installing Base with Vehicle Belt



WARNING:

DO NOT use both the LATCH: lower anchor belt and vehicle belt at the same time to install the car seat.

DO NOT leave child restraint in Side-Facing mode while vehicle is in motion.

Even when unoccupied, this child restraint **MUST** be firmly secured to the vehicle with the lower anchor belt or with the vehicle seat belt in Rear-Facing mode.



Before installing the car seat in your vehicle, check if the buckle position needs to be adjusted for your child.

See page 25 for Rear-Facing buckle positions.

Review Vehicle Owner's Manual

Determine what kind of vehicle belts your car has and how to use them to lock a car seat in place **OR** where LATCH: lower anchor seating positions are located in your vehicle.

1

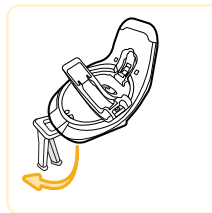

Unfold Load Leg

When possible, utilize the load leg.

In a crash, load legs reduce downward rotation, limit rebound, provide additional stability, and energy absorption.



WARNING:

DO NOT fully extend yet. **DO NOT** use the load leg to adjust the base angle.

Review your vehicle owner's manual for load leg use.

2



Place Base in Vehicle Seat

The car seat base **MUST** be flat on the vehicle seat.

Squeeze the rotation handle and swivel the seat to face you in side view.

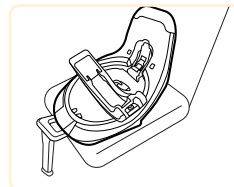

Squeeze the release handle located on the front of the car seat.



For LATCH Belt, go to page 9 to bypass the lock off.
For Lap Belt only, skip Step 3 and leave lock off closed.

3

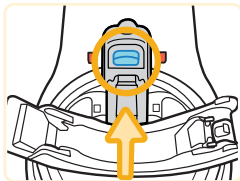

Open Belt Lock Off

Squeeze the lever to open the belt lock off & pull it forward.

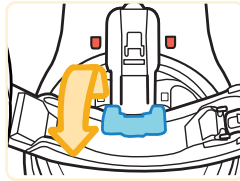

4

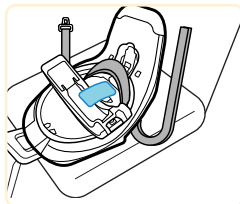

Weave Vehicle Seat Belt In and Out of Belt Path As Shown

Buckle the vehicle belt.

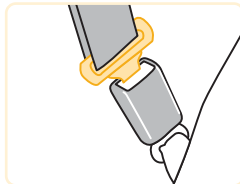

5

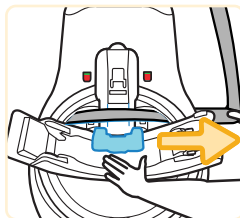

Tighten Belt & Gently Remove Slack

Place your hand in the base and firmly push the base down and back toward the vehicle seat. Pull the belt parallel (in line) with the belt path as shown.

6

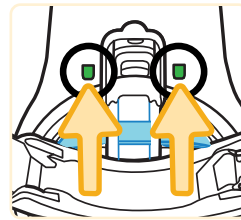

Close Belt Lock Off

Both indicators will turn **completely green** when vehicle belt is properly installed.

i

If your car has a vehicle belt that can switch to locking mode, you **MUST** use it to lock the belt.

Switching vehicle belt to locking mode: Slowly pull the shoulder belt all the way out, then let it go back in 1-2 in. (2.5-5 cm).

As it goes back in, you will most likely hear a ratcheting sound.

Gently pull the belt to see if it has locked. You will not be able to pull any more belt out if the lock has engaged.

7

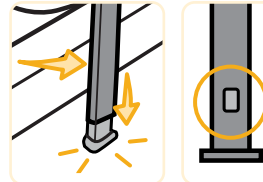

Extend Load Leg

Squeeze the button (located at back of the leg) on the load leg and pull it down until it meets the vehicle floor.

Release the button.

Lift the front of the base while holding the load leg in place as shown to lock it into position.

It **MUST BE** perpendicular to the vehicle floor.

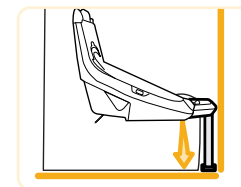



WARNING:

Do not use the load leg if it does not reach the floor of your vehicle.

Do not use the load leg on top of vehicle storage compartments.

Review your vehicle owner's manual.



If the base moves more than 1 in. (2.5 cm) side to side at the belt path, you can try:

Pulling the belt tighter; **OR**

Reinstalling the base; **OR**

Changing to a different seating location; **OR**

Switching to a different install method (LATCH: Lower Anchor Belt).

FINISHED!

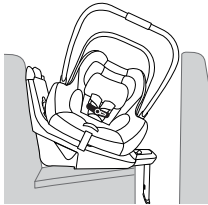

Belt Tension Indicators Completely Green?

If they are not green, see steps 3-6.

Car Seat Cradle Side-Facing As Shown? If it is not side-facing, squeeze the rotation handle and move it into side-facing position.

Rear-Facing Child Fit: pages 23-27.

When using the passenger and driver side locations, where possible, the car seat **MUST** be touching the back of the seat in front of it.

Installing Base with LATCH: Lower Anchor Belt



WARNING:

DO NOT use both the LATCH: lower anchor belt and vehicle belt at the same time to install the car seat.

DO NOT leave child restraint in Side-Facing mode while vehicle in is motion.

Even when unoccupied, this child restraint **MUST** be firmly secured to the vehicle with the lower anchor belt or with the vehicle seat belt in Rear-Facing.



Before installing the car seat in your vehicle, check to see if you need to adjust the buckle position for your child.

Review Vehicle Owner's Manual

Determine what kind of vehicle belts your car has and how to use them to lock a car seat in place **OR** where LATCH: lower anchor seating positions are located in your vehicle.

1

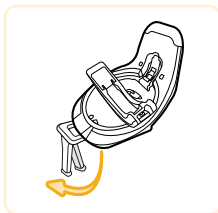

Unfold Load Leg

When possible, utilize the load leg.

In a crash, load legs reduce downward rotation, limit rebound, provide additional stability, and energy absorption.



WARNING:

DO NOT fully extend yet. **DO NOT** use the load leg to adjust the base angle.

Review your vehicle owner's manual for load leg use.

2



Place Base in Vehicle Seat

The car seat base **MUST** be flat on the vehicle seat.

Squeeze the rotation handle and swivel the seat to face you in side view.

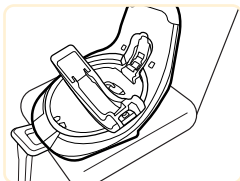

Squeeze the release handle located on the front of the car seat.

3

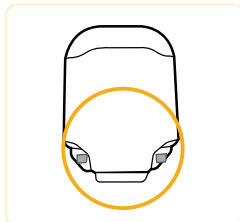

Take Lower Anchor Belt Out of Storage Location

i

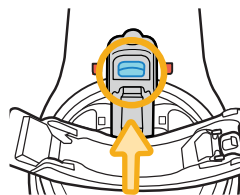

Vehicle Belt Lock Off **MUST BE** Closed **BEFORE** Routing Lower Anchor Belt

4

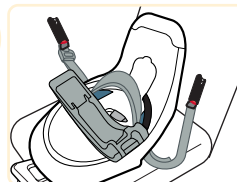

Weave Lower Anchor Belt In & Out of Belt Path

You may need to fully lengthen the belt before routing it into the belt path. Squeeze the adjuster button and pull the belt out as shown.



Weave the connector without the adjuster closest to it through the belt path.

5



Attach LATCH Connectors to Vehicle's LATCH Anchors

Review your vehicle owner's manual for LATCH anchor locations and LATCH belt use.

Make sure arrows on connectors are facing up.

Fasten one LATCH belt connector to the anchor located in the vehicle seat.

Repeat for the other side of the car seat.

6

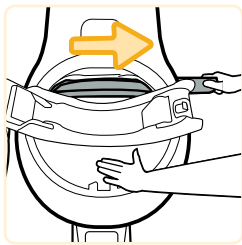

Tighten Belt & Gently Remove Slack

Place your hand in the base and firmly push the base down and back toward the vehicle seat.

Pull the belt parallel (in line) with the belt path as shown.

Tension indicators will begin to turn **green**.

Both indicators will turn **completely green** when the LATCH is properly installed.

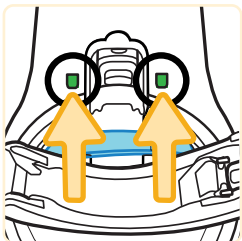

i

If the base moves more than 1 in. (2.5 cm) side to side at the belt path, you can try:

Pulling the belt tighter; **OR**

Reinstalling the base; **OR**

Changing to a different seating location; **OR**

Switching to a different install method (vehicle belt).

7

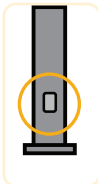
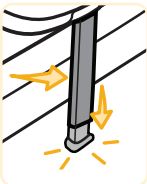

Extend Load Leg

Squeeze the button (located on back of leg) on the load leg and pull it down until it meets the



vehicle floor.

Release the button.

Lift the front of the base while holding the load leg in place as shown to lock it into position.

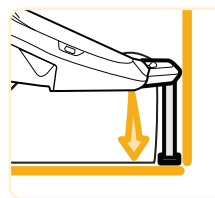

It **must be** perpendicular to the vehicle floor.



WARNING:

Do not use the load leg if it does not reach the floor of your vehicle. **Do not** use the load leg on top of vehicle storage compartments.

Review your vehicle owner's manual.

FINISHED!



Belt Tension Indicators Completely Green?

If they are not green, see steps 4 & 5.

Car Seat Cradle Side-Facing As Shown? If it is not side-facing, squeeze the rotation handle and it move into side-facing position.

Rear-Facing Child Fit: pages 23-27.

When using the passenger and driver side locations, where possible, the car seat **MUST** be touching the back of the seat in front of it.

Rotating & Reclining Car Seat on Base

Rotating Car Seat

You must squeeze the **Rotation Handle** on the front of the base to move the seat out of Rear-Facing.



Rotation Handle

Rotation Lock Indicator will show the **locked** symbol when car seat is locked in place.

! WARNING:

SIDE-FACING Position ONLY for use when:
Placing child into car seat.
Removing child from car seat.

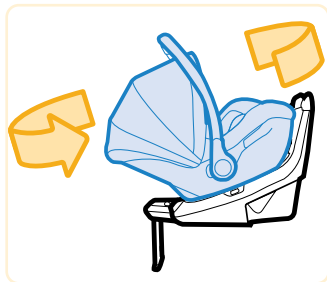

Side-Facing Position (Towards Parent)

To rotate the car seat from Side-Facing, firmly rotate the seat towards the back of the base.

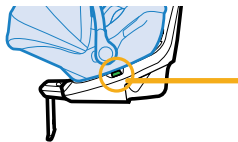

Rotation Lock Indicator will show the **locked** symbol when car seat is locked in place.

Reclining Car Seat

There are 5 Recline positions.

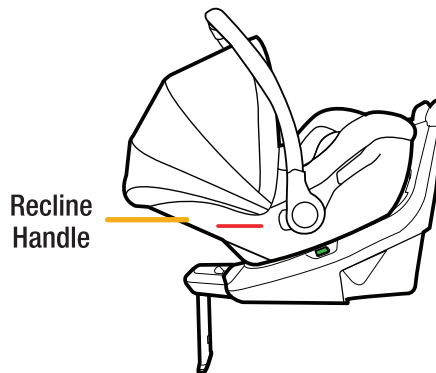

Recline Handle

To Recline: Squeeze the recline handle and push the top of the car seat back.

For More Upright: Squeeze the recline handle and pull the top of the car seat forward.

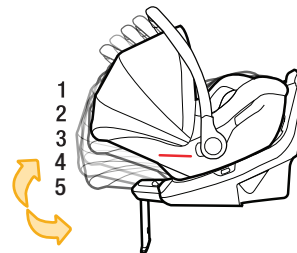

For children **who cannot sit up unassisted**, the **Rear-Facing Level Line** on the car seat **MUST** be parallel with the ground using **any position**.

For children **who can sit up unassisted**, you may make the car seat more upright in **any position**.

i

The load leg is stored under the base. When possible, utilize the load leg

The base install is equally safe with or without the use of the load leg.

In a crash, load legs reduce downward rotation, limit rebound, provide additional stability, and energy absorption.

1

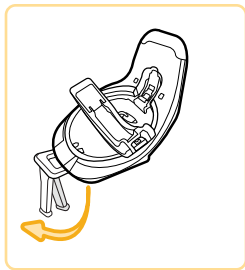

Fold the load leg out

2

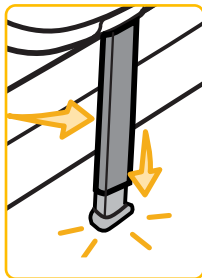

Squeeze button on load leg

The button is located on the back of the load leg.

Pull it down until it meets the vehicle floor.

Release the button.

Lift the front of the base while holding the load leg in place to lock it into position.

3

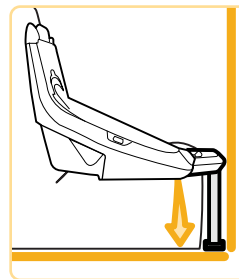

Check to see if Perpendicular

It **MUST BE** perpendicular to the vehicle floor.

! WARNING:

DO NOT use the load leg on top of vehicle storage compartments. Review your vehicle owner's manual.

DO NOT use the load leg if it does not reach the floor of your vehicle. When not in use, the load leg must be stored under the base.

Removing and Installing Car Seat to Base

The Car Seat Cradle **MUST BE Side-Facing** to attach or remove the car seat from the base.

To recline car seat, see page 16.

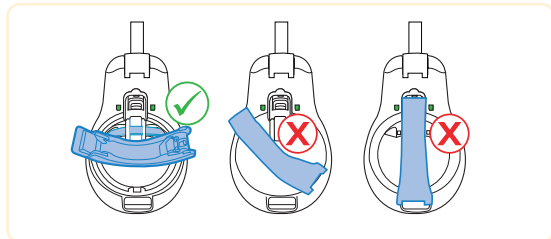

i

Before installing the car seat in your vehicle, check to see if you need to adjust the buckle position for your child.

Review Vehicle Owner's Manual

Determine what kind of vehicle belts your car has and how to use them to lock a car seat in place **OR** where LATCH: lower anchor seating positions are located in your vehicle.

If you are having issues with the car seat going back onto the base, check on the switch located as shown.

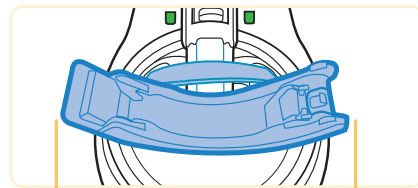
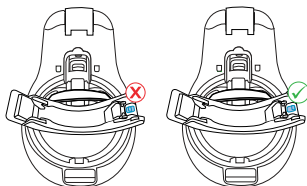

Back of Car
Seat Goes Here

Front of Car
Seat Goes Here

Installing Car Seat to Base

1

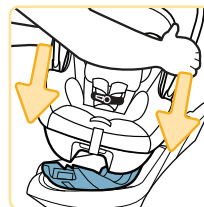

Align Bar on Back of
Car Seat into Cradle

2

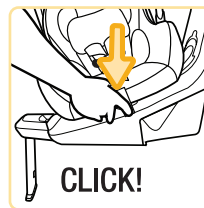

Push Down on Front
of Car Seat to
Lock into Cradle

FINISHED!



The car seat has been
installed into the
Side-Facing position.

To Remove Car Seat from Base

1. Squeeze the Car Seat Release Handle.
2. Pull Car Seat up from the base.



**4-30 lb (1.8-13.6 kg) and
32 in. (81.3 cm) or less in height**

Children under 1 year of age **MUST** ride Rear-Facing.

This car seat can only be used **Rear-Facing**.

Weight Limit: 30 lb (13.6 kg); **OR**

Height Limit: 32 in. (81.4 cm); **OR**

Rear-Facing Child Fit requirements, see pages 23-27.

Please see page 3 for accessory use.

WARNING:



NEVER install a rear-facing child restraint in the front seat of a vehicle equipped with an active frontal airbag.

DO NOT use the lower anchor belt along with the vehicle lap or lap/shoulder belt.

DO NOT fasten multiple lower anchor connectors on the same lower anchor bar in the vehicle.

Check the vehicle belt or the lower anchor belt before each use. Use **ONLY** if the belt can be tightened properly and locked securely in place.

DO NOT leave child restraint in Side-Facing mode while vehicle is in motion.

Even when unoccupied, this child restraint **MUST** be firmly secured to the vehicle with the lower anchor belt or with the vehicle seat belt.

This child restraint **MUST ALWAYS** face the rear of the vehicle until the child has reached the maximum weight or height limit.

1



Attach Car Seat to Base

Align bar on back of car seat into cradle.

Push down on front of car seat to lock into cradle.

The car seat base **MUST** be flat on the vehicle seat.

2

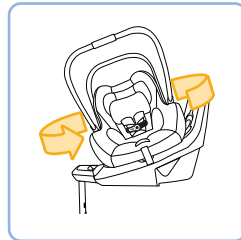

Rotate Car Seat in Side-Facing Position on Base

Squeeze the rotation handle and swivel the seat to face you in side view.

3

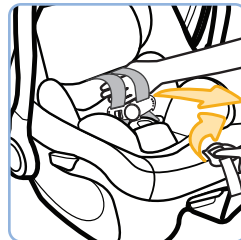

Fully Loosen Harness Straps

Push down on the harness release lever (through the opening in the pad) while pulling at or below the harness covers as shown.

4

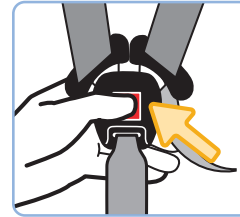

Undo Buckle

5

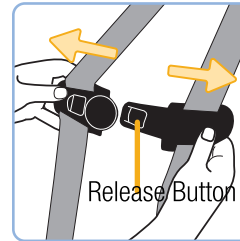

Undo Chest Clip

Hold each side of the chest clip.

Press the release button with your thumb.

Pull the chest clip and release button apart.

6

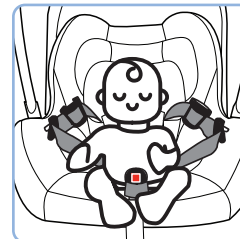

Place Child in Car Seat

Your child's bottom and back should be flat against the car seat.

7

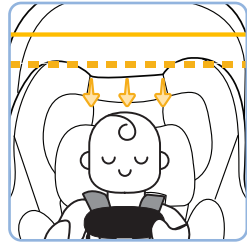

Check Headrest Position

The top of your child's head **MUST be at least 1 in. (2.5 cm) below** the top of the car seat's headrest.

8

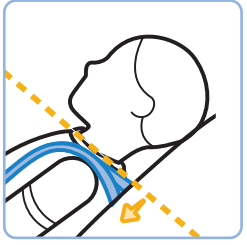

Check Harness Strap Position

The harness strap **MUST be at or slightly below** the shoulders, never above.

9

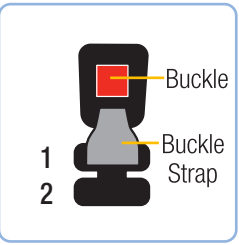

Check Buckle Position

Use the slot closest to your child.
The buckle **should not be underneath or behind** your child.

10



Rotate Car Seat Towards Rear-Facing Position

Rotation Lock Indicator will show the **locked** symbol when car seat is locked in place.

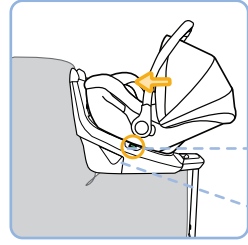

Check **Rear-Facing Level Line**.

i

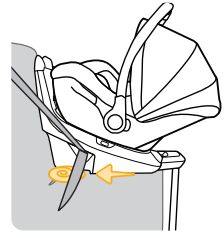

Only if necessary, you may place a tightly rolled towel(s) or foam pool noodle(s) under the front of the car seat base to help make the **Rear-Facing Level Line** parallel with the ground.

Check often to make sure padding is still in place and the belt is tight.

i

- To secure child in car seat, see pages 33-36.
- To change the harness strap height, see page 41.
- To change the buckle position, see pages 38-40.
- To learn how to check harness tightness, see pages 33-36.

FINISHED!

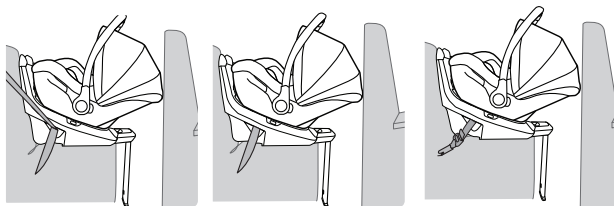
Lap/Shoulder
Belt

Lap Belt

LATCH: Lower
Anchor Belt

- ✓ **Headrest Position:** Is your child's headrest in the correct position? See step 6.
- ✓ **Harness Strap Position:** Is your child's harness strap in the correct position? See step 7.
- ✓ **Buckle Position:** Is your child's buckle in the correct position? See step 9.
- ✓ **Base Vehicle Belt Install:** See page 5.
- ✓ **Base LATCH: Lower Anchor Belt Install:** See Page 9.

When using the passenger and driver side locations, where possible, the car seat **MUST** be touching the back of the seat in front of it.

Lap/Shoulder
Belt

OR



Lap Belt

**Review Vehicle Owner's Manual**

Determine what kind of vehicle belts your car has and how to use them to lock a car seat in place **OR** where LATCH: lower anchor seating positions are located in your vehicle.

1

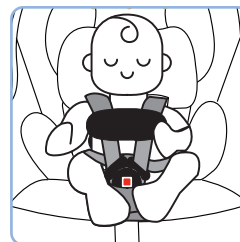
**Secure Child in
Car Seat**

To properly secure your child in the car seat, see pages 33-36.

Check your child's fit often and make any needed adjustments to the car seat as they grow.

2

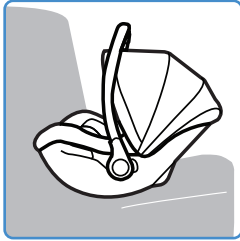

Place Car Seat in Vehicle Rear-Facing

Center the car seat in the chosen seating position.

The carry handle must be upright and locked when carrying and when installed in the vehicle.

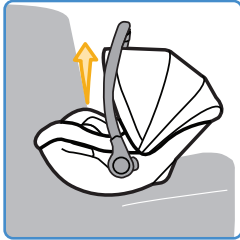

3

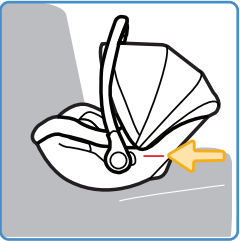

Check Level Line

Check the level line on the side of shell to see if it is parallel with the ground.

Adjust if needed.

4

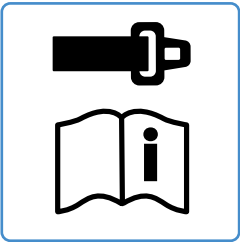

Check if Your Vehicle Belts Will Work With This Car Seat

This is very important because **not all vehicle belts will work with car seats.**

Review pages 51-54 and your vehicle owner's manual to find out what kind of vehicle belts you have and how to lock a car seat in place.

5

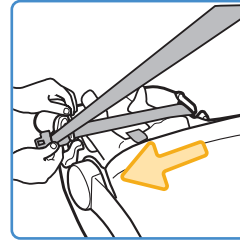

Route Vehicle Lap or Lap Portion of the Lap/Shoulder Belt Through Shell Belt Path on Both Sides of Shell As Shown

6

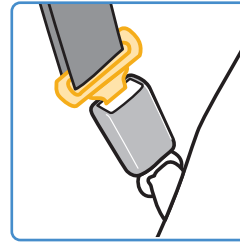

Buckle Vehicle Belt

If your car's vehicle belt has a switchable retractor, use it to lock the vehicle belt. For information about switchable retractors, see page 57 or review your vehicle owner's manual.

7

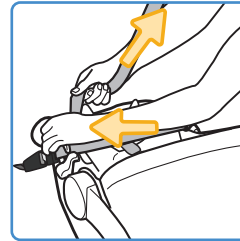

Tighten Belt

Lay your forearm across the car seat at the belt path while pulling the shoulder belt or the free end of the lap belt to tighten.

8

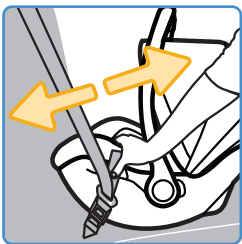

Check Belt Tightness

Hold the car seat at the belt path with your weaker hand. Push and pull from side to side.

It should not move more than **1 in.** (2.5 cm).

i

If it moves more than 1 in. (2.5 cm), you can try:

Pulling the belt tighter; **OR**

Reinstalling the car seat; **OR**

Changing to a different seating location

9

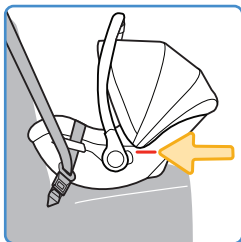

Recheck Level Line

Redo the installation if level line is not parallel with the ground.

i

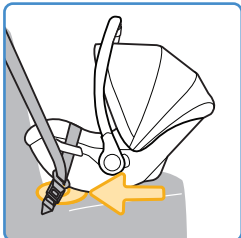

Only if necessary, you may place a tightly rolled towel(s) or foam pool noodle(s) under the front of the car seat base to help make the **Rear-Facing Level Line** parallel with the ground.

Check often to make sure padding is still in place and the belt is tight.

FINISHED!

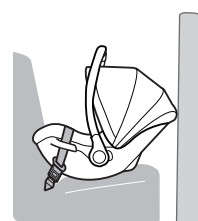
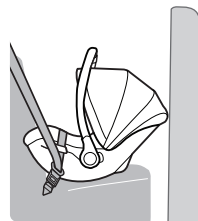

Lap/Shoulder
Belt



Lap Belt

- Carry Handle Position:** Is your carry handle in the correct position? See step 1.
- Level Line:** Is your child's car seat level line parallel? See step 2.
- Rear-Facing Check Fit:** See page 23.
- Base Vehicle Belt Install:** See page 5.

When using the passenger and driver side locations, where possible, the car seat **MUST** be touching the back of the seat in front of it.

1

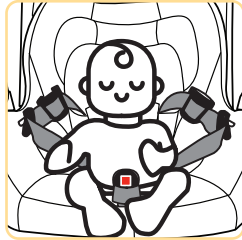

Place Child in Car Seat

Your child's bottom and back should be flat against the car seat.

Position the harness straps over your child's shoulders and upper thighs.

2

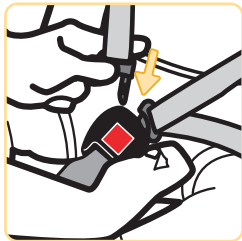

Buckle Harness

Push the buckle tongues into the buckle until you hear them "click".

Pull up on the harness straps to make sure the buckle is locked.

3

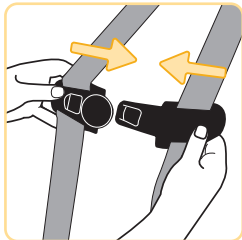

Fasten Chest Clip

Insert the right half of chest clip into the left half.

Gently push each half of the chest clip together.

Pull gently on each half of the chest clip together to make sure it is locked.

4

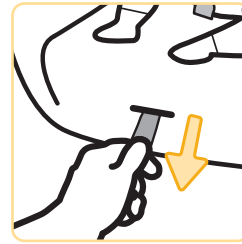

Tighten Harness

Pull the harness adjustment strap straight out to snugly tighten the harness.

5

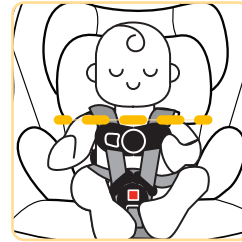

Position Chest Clip

Pull the harness covers down on the child.

Place the chest clip on the lower part on the harness cover so that the harness covers are between your child and the chest clip.

Position it at mid-chest (even with armpits) and away from your child's neck.

6

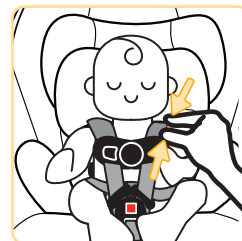

Check Harness Tightness

Unfasten the harness covers.

Try to pinch the harness at the shoulders vertically between index finger and thumb as shown.

If your fingers slip off, the harness is tight enough.

If you can pinch the harness strap, tighten more.

Fasten the harness covers.

i

A snug strap should not allow any slack.
It lies in a relatively straight line without sagging.
It does not press on the child's flesh or push the child's body into an unnatural position.

7



Rotate Car Seat towards Rear-Facing Position

Rotation lock indicator will show the **locked** symbol when car seat is locked in place.

FINISHED!



Your child is now secured in the car seat.
Check your child's fit often and make any needed adjustments to the car seat as they grow.

To Remove Child from Car Seat:

1. Loosen Harness Strap
2. Unbuckle Harness
3. Release Chest Clip
4. Remove Child

Troubleshooting

1. If the buckle or harness release lever sticks: DO NOT lubricate. Check for dropped food, sticky spilled drinks, dirt, leaves, etc.

Clean with warm water and/or remove the object with tweezers. If you cannot get the harness to adjust and remain tight with the buckle securely locked, **DO NOT** use this car seat.

2. If your harness twists: Straighten the harness each time you put your child in the car seat. Lock the buckle and tighten the harness so it will be ready for next use.



WARNING:

Failure to fasten and tighten the harness system correctly may allow the child to be ejected from the child restraint in a crash or sudden stop causing serious injury or death. Serious injury can include paralysis and/or permanent brain damage.

DO NOT mistake comfort for safety. The harness system **MUST** be snugly adjusted.



DO NOT put snowsuits or bulky garments on your child when placing them in the child restraint.

Bulky clothing can prevent the harness straps from being tightened properly.

Changing Headrest/ Harness Height

1

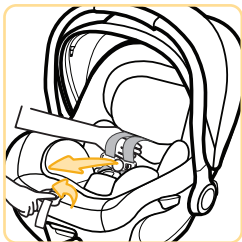

Fully Loosen Harness Straps

Push down on the harness release lever (through the opening in the pad) while pulling at or below the harness covers as shown.

2

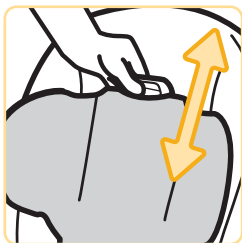

Adjust Headrest/ Harness Height

1. Squeeze the adjustment handle lever up.
2. Move the headrest up or down to the proper height for your child.

3. Release the handle to lock in place.
4. Make sure it is locked securely.

i

For Rear-Facing Child Fit, see page 23-27.

To learn how to check harness tightness, see pages 33-36.

Check the harness straps often for any wear or damage.

Changing Buckle Position



WARNING:

Failure to place buckle's metal retainer completely through pad and child restraint can result in serious injury or death. Serious injury can include paralysis and/or permanent brain damage.

1



Undo Buckle

2

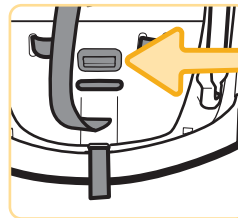

Turn Car Seat Over

Locate the buckle's metal retainer on the bottom of the shell.

3

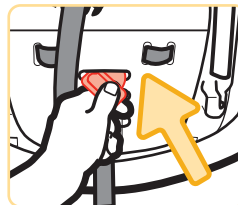

Rotate Metal Retainer and Push It Up Through Shell and Pad

4



From Top of Car Seat, Pull Buckle Out of Shell and Pad

5



Insert Buckle's Metal Retainer into Buckle Slot Closest to Your Child

The buckle **must** face out.

6

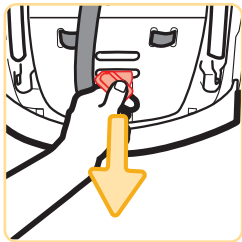

From Bottom of Car Seat, Pull Buckle's Metal Retainer Completely Through Pad and Shell

7

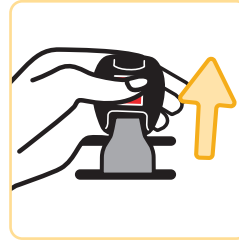

Check Buckle

Pull up on the buckle to make sure it is secured.

The buckle **must not** pull out.

i

For Rear-Facing Child Fit, see page 23-27.

Check your child's fit often. If you cannot achieve a snug harness fit for your child, see pages 41-42.

To learn how to check harness tightness, see pages 33-36.



If you cannot achieve a snug harness fit for your child, make these adjustments.

1

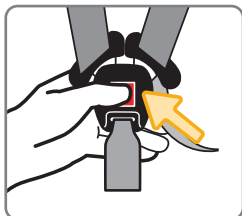

Undo Buckle & Undo Chest Clip

Hold each side of the chest clip.
Press the release button with your thumb.
Pull the chest clip and release button apart.

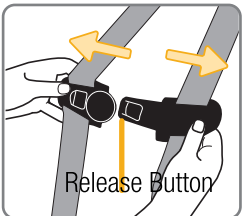

2

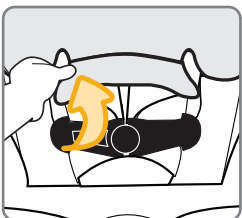

Undo Fasteners on Seat Pad

Pull the car seat pad towards you.

3

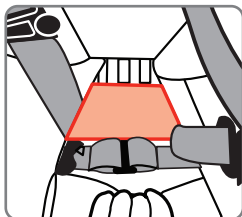

Locate Foam under the Seat Pad

Undo the fastening strips as shown.

4

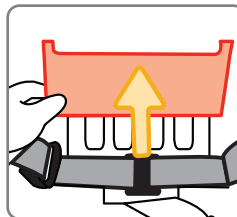

Remove Foam
from Car Seat Shell

5

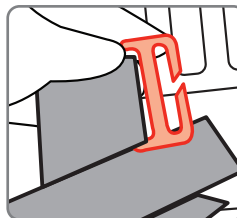

Unloop Harness
Strap from Clip

6

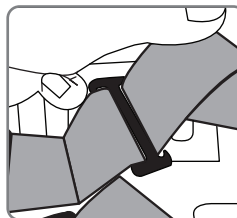

Attach 2nd Harness
Strap Loops

7

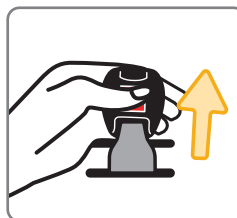

Replace Foam and
Seat Pad and
Check Buckle

Pull up on the buckle to make sure it is secured.
The buckle **must not** pull out.



For Rear-Facing Child Fit, see page 23-27.

To learn how to check harness tightness, see pages 33-36.



To Adjust Carry Handle

Squeeze both of the adjustment buttons on each side of the carry handle.

Rotate the carry handle up or down to the desired location. Release the buttons.

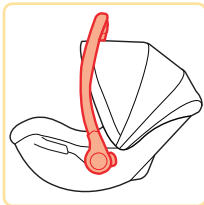

Make sure both carry handle adjustment buttons are in the locked position.

The carry handle must be upright AND locked when carrying and when installed in the vehicle.

! WARNING:

Read ALL instructions before using child restraint as a carrier.

NEVER use carrier unless child is properly secured.

Use only as a carrier by children weighing 4-30 pounds (1.8-13.6 kg) and 32 inches (81.3 cm) or less in height.

NEVER leave child unattended. Always keep child within arm's reach.

Suffocation Hazard: Infant carrier can roll over on soft surfaces and suffocate child. **NEVER** place carrier on beds, sofas or other soft surfaces.

Strangulation Hazard: Children have **STRANGL**ED in loose or partially buckled harness straps. Fully restrain the child even when carrier is used outside the vehicle.



Fall Hazard: Child's activity can move carrier. **NEVER** place carrier on counter tops, tables, or any other elevated surface.

The carrier can fall from the shopping cart. Do not use on shopping cart.

Do not use the carrier if it is damaged or broken, or if any parts are missing.

! WARNING:



Do not use this canopy with children who have an implanted electronic medical device. A magnet is used to help secure the canopy locking mechanism together which may interfere with the proper function of an implanted electronic medical device.

Parents or caregivers who have an implanted electronic device should keep their device away from the canopy and consult their doctor and medical device manufacturer for specific information before using this canopy.



For wash and care instructions, see page 50.

Removing Canopy

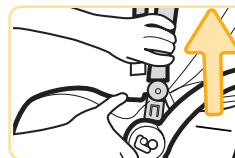

Pull Canopy Hub Off of Shell

Installing Canopy

1

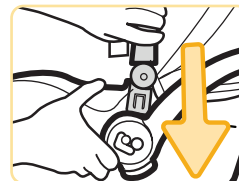

Attach Canopy Hubs to Shell

2

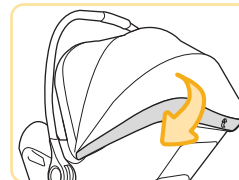

Pull Canopy Over Back of Shell Over Edge

To Extend Canopy

1

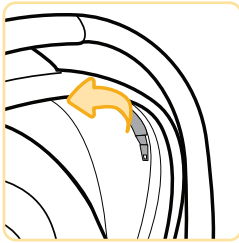

Unzip pocket on front of canopy

2



Pull extended canopy out of pocket

3

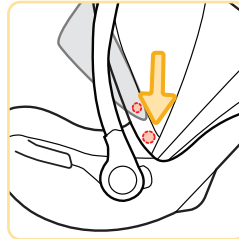

Attach magnets to inside of canopy

4

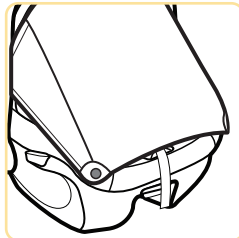

Attach magnets to front of car seat

i

You do not need to remove the harness system to remove the pad from the car seat.

DO NOT fully pull the harness strap out of the car seat. Leave it threaded in the hip harness slots. If removed, you will not be able to rethread it.

To remove accessories, see pages 3.

1

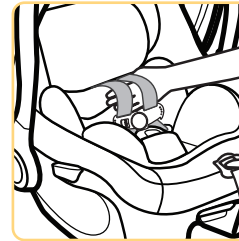

Fully Loosen Harness Straps

Push down on the harness release lever (through the opening in the pad) while pulling at or below the harness straps as shown.

2

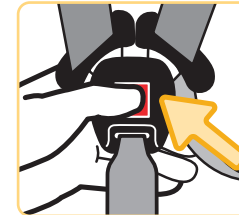

Undo Buckle & Undo Chest Clip

Hold each side of the chest clip. Press the release button with your thumb. Pull the chest clip and release button apart.

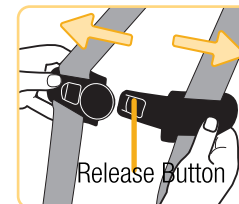

3

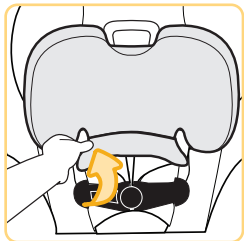

**Undo Fasteners on
Headrest Pad and
Gently Pull
Headrest Pad Off
Top of Headrest**

4

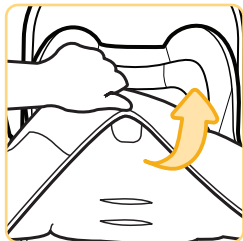

**Pull Seat Pad Off
Sides & Bottom of
Car Seat**

5

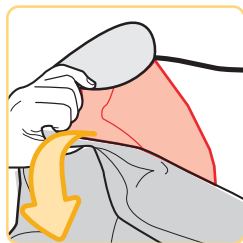

**Pull Seat Pad
Around Headrest &
Off of Car Seat**

Cleaning Pad & Accessories

MUST turn car seat pad inside-out before machine washing. Machine wash separately with cold water on a gentle cycle. **DO NOT** use bleach. Tumble dry separately for 10-12 minutes on low heat. Remove immediately.

Cleaning Harness Strap

Check the harness straps often for any wear or damage.

Spot clean using warm sudsy water and damp cloth. Spilled food and liquids on the car seat may result in mold or bacterial growth over time. These spills could also attract insects or rodents.

Cleaning Buckle & Car Seat

Spot clean using warm sudsy water and damp cloth. **DO NOT** submerge into water.

Installing Seat Pad Set

1. Lower Headrest to Middle of Car Seat
2. Pull Seat Pad Around Headrest
3. Pull Seat Pad around Sides & Front of Car Seat
4. Adjust Headrest to Highest Position
5. Pull Headrest Pad onto Headrest
6. Attach All Pad Fasteners



WARNING:

DO NOT use the child restraint without the seat pad or with damaged harness straps.

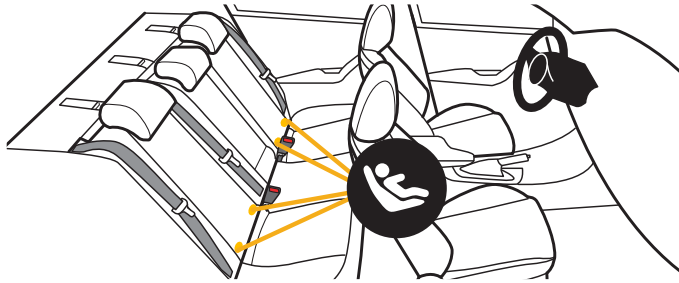

Your vehicle's features may be considerably different than those pictured here.

The lower anchors of **LATCH** (Lower Anchors and Tethers for Children) is a universal system for installing car seats without using vehicle seat belts. The LATCH: lower anchor belt can **ONLY** be used in vehicles that have the lower anchor bars installed in designated seating positions. Most vehicles manufactured after September 2002 are equipped with LATCH: lower anchor bars. Check your vehicle owner's manual to see which seating positions may be equipped with LATCH: lower anchor bars.

Lower Anchor Belt Parts

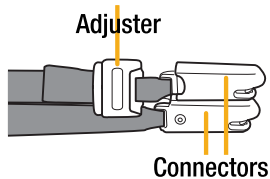

Lower Anchor Belt Storage Location

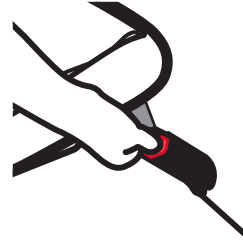
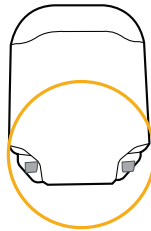

To Remove Lower Anchor Belt from Vehicle's Lower Anchor Bars

1. Remove the tension from the belt by pushing down on the side of the car seat with the adjuster.
2. Then press the adjuster's button to loosen the belt.
3. Press the release button on each connector, then pull the connectors out of the vehicle seat.

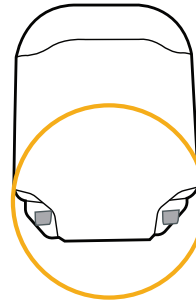

To Store Lower Anchor Belt

The lower anchor belt **MUST** be properly stored in its storage location when:

using the vehicle belts to install the base; **OR**

the base is not installed in a vehicle.

Gather the lower anchor belt and place it into the storage location as shown.



WARNING:

DO NOT use both the lower anchor belt and vehicle belt at the same time.

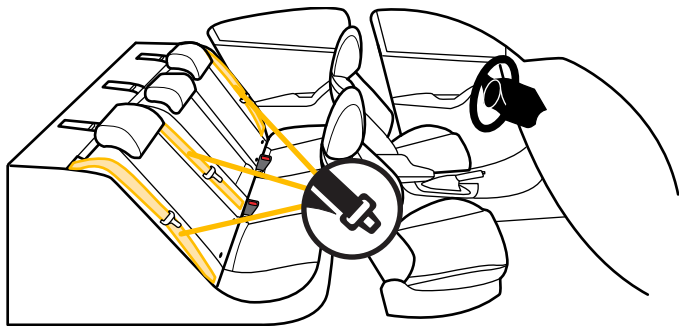

Your vehicle's features may be considerably different than those pictured here.

If LATCH: lower anchors are not an option or if your child weighs more than **25 lb (11 kg)**, in **Rear-Facing Mode** you **MUST** use the vehicle seat belt system to install the car seat.

Not all vehicle belts and seating positions will work with car seats. Please go through the following steps to understand how to lock a car seat in Rear-Facing Mode with a vehicle belt.

1

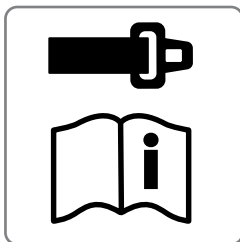

You **MUST** Review Your Vehicle Owner's Manual

Your vehicle owner's manual will let you know which vehicle belts and seating positions car seats can be installed in.

2



Check How This Car Seat Will Be Locked Into Place

The vehicle belt **MUST NOT** loosen after tightening.

This means there needs to be a way to lock the vehicle belt.

The ways this can be done are:

- By using the seat belt's retractor (see step 3); **OR**
- By using the seat belt's latch plate (see step 4).

3

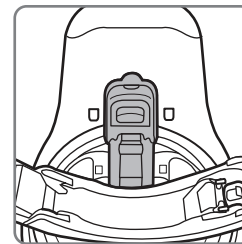

Lock Off

The vehicle belt retractor **MUST** be locked after closing the lock off.

Please go to the vehicle belt with base installation section of the manual to see how to properly use this feature.

Base Install with Vehicle Belt: **Page 5**

4

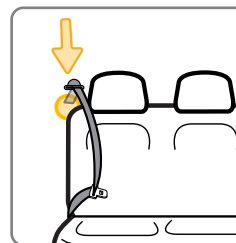

Check Retractor

Retractors pull seat belts into stored positions and lock the belt to hold passengers in place.

See the next page for some common types of vehicle belt retractors that will work with this car seat.

Types of Retractors

Switchable Retractor

(most vehicles have this type)

This retractor can be switched to a locking mode.

You **MUST have the retractor in the locking mode** to use the seat belt with this car seat.

Switching to locking mode: Slowly pull the shoulder belt all the way out, then let it go back in **1-2 in.** (2.5-5 cm).

As it goes back in, you will most likely hear a ratcheting sound.

Gently pull the belt to see if it has locked. You will not be able to pull any more belt out if the lock has engaged.

Automatic Locking Retractor

This retractor always locks.

It will automatically lock after slowly pulling the seat belt out at least halfway and letting the belt go back into the retractor **1-2 in.** (2.5-5 cm).

Emergency Locking Retractor

See Step 5
“Check Latch Plates”

If the retractor does not lock, it is most likely an Emergency Locking Retractor. These retractors only lock during a sudden stop or collision.

You will need to determine if your seat belt’s latch plate can lock the belt. See step 5, “Check Latch Plates”.

5



Locking
Latch
Plate



Emergency
Locking
Retractor with
a Sliding Latch
Plate

Check Latch Plates

Latch plates are the part of the seat belt that goes into the buckle.

To see if the latch plate locks:

1. Buckle Vehicle Belt
2. Firmly Tug Lap Portion of Seat Belt While Pulling It Up

If the vehicle belt does not slide through the latch plate, it’s locked.

If the latch plate slides up and down the vehicle belt, it is a **sliding latch plate**.

Sliding latch plates easily slip between the lap and shoulder portions of the belt.

i

**Never Use the Following With
This Car Seat:**

**Emergency Locking Retractor Lap Only Belt
Inflatable Seat Belts**

**WARNING:**

NEVER take your child out of the child restraint while the vehicle is moving.

NEVER leave your child unattended. Placing your child in a hot child restraint may result in burns.

DO NOT use a child restraint with damaged or missing parts.

DO NOT use a child restraint with cut, frayed, or damaged harnesses.

DO NOT substitute parts or try to modify the child restraint in any way. **DO NOT** lubricate buckles and fasteners.

DO NOT use any child restraint accessory except those approved by Dorel Juvenile Group.

NEVER allow any child to play with this child restraint; it is not a toy.

DO NOT remove or cover up any of the warning labels or other labels on the child restraint.

This child restraint has been certified for use in passenger vehicles. **DO NOT** use in a boat, on a motorcycle or in a cargo van or bus where there are no seat belts or tether anchors.

Read all instructions for additional warnings.

**WARNING:**

NEVER place a child rear-facing in a seating position with an active frontal air bag.

Check the vehicle owner's manual for more information about air bag/child restraint use.



Use the child restraint only on vehicle seats that face forward.



DO NOT use on seats that face the sides or rear of the vehicle.

For vehicles without a back seat, refer to your vehicle owner's manual.



According to accident statistics, children are safer when properly restrained in the rear seating positions than in the front seating positions.

Rear seating positions are statistically safer, whether you have air bags, advanced air bags, or no air bags at all.

If you are not sure where to place the car seat in your vehicle:

- Consult your vehicle owner's manual; **OR**
- Contact Dorel Juvenile Group Consumer Care Department; **OR**
- Visit your local Child Passenger Inspection Station. Go to <https://www.nhtsa.gov/equipment/car-seats-and-booster-seats> to find your closest station.

To avoid your child being seriously burned, take the following precautions:

Park in the shade or where the sun does not directly hit the car seat.

Cover the car seat with a sheet or blanket when not in use.

Check for hot seat and buckles before placing child in car seat.

To help protect your vehicle seat's upholstery from damage: you may use an accessory approved by Dorel Juvenile Group or a single layer towel underneath and behind car seat.



WARNING:

Check the vehicle belt or lower anchor belt before each use. Use only if the belt can be tightened properly and locked securely in place.

Even when unoccupied, this child restraint **MUST** be firmly secured to the vehicle with the lower anchor belt or with the vehicle seat belt.

In a crash or sudden stop, an unsecured child restraint could injure occupants.

DO NOT risk your child's safety.

To keep your child as safe as possible, Dorel Juvenile Group strongly recommends replacing the car seat even after a minor crash, even if it was not occupied at the time.

Replacement After a Minor Crash

The National Highway Traffic Safety Administration states that for a crash to be considered minor **ALL of the following MUST be true:**

Vehicle able to drive away from the crash site; **AND**

Vehicle door nearest the car seat was not damaged; **AND**

No passengers were injured; **AND**

Airbags did not deploy; **AND**

There is no visible damage to the car seat.

If the crash your car seat was involved in meets **ALL** the criteria, you may not need to replace the car seat.

If one or more of these criteria are not true or if you are uncertain of any of your answers, replace the car seat immediately.

Replacement After a Moderate to Severe Crash

You **MUST** replace this car seat if it has been in a moderate to severe car crash.

This car seat is intended to protect a child in a single crash. During a crash, the car seat and all of its parts absorb crash energy which can deform or weaken it. Damage is not always visible. A damaged car seat **MUST** be replaced immediately.

Expiration

On the bottom of the car seat there is a date of manufacture label as shown.

DO NOT use this car seat more than 8 years after the date of manufacture.

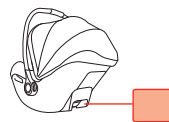

0515079		Tear Off and Mail This Part or Register Online		4348-0081D	
Consumer: Just fill in your name, address and email. Please print (use dark ink).					
Your Name					
Your Street Address					
City		State		Zip Code	
Email Address (optional)					
Model Number		Model Name		Manufacture Date	
AB123CDE		Brand Car Seat		05/16/2015	
		L#11 B265035			

Example of model number, manufacture date, and line code.

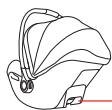

If you don't have the card or if your address changes, you will find the model number, manufacture date, and line code on the label located on the bottom of the car seat.

Please complete the postage-paid registration card that came with your child restraint, and send it to us.

Child restraints could be recalled for safety reasons.

You must register this restraint to be reached in a recall.

Send your name, address, e-mail address if available and the restraint's model number and manufacturing date to:

Dorel Juvenile Group

2525 State Street
Columbus, IN 47201

or call 1-800-951-4113 or register online at
www.djgusa.com/registration/carseat/us.

For recall information, call the U.S. Government's Vehicle Safety Hotline at 1-888-327-4236 (TTY: 1-800-424-9153), or go to www.NHTSA.gov.



This restraint is certified for aircraft use when used with the internal harness.

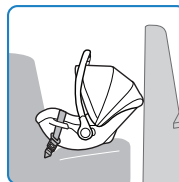

Rear-Facing Aircraft Installation

Follow the steps on pages 28-33.

Install the car seat in a window seat to avoid blocking the aisle. If the aircraft lap belt is too short, ask the flight attendant for a belt extender. Use only on forward-facing aircraft seats. Contact the airline for their specific policies.

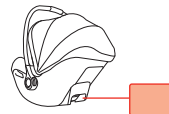

Some airlines may ask to see a label stating that this car seat is certified for aircraft use.

There is an airplane certification label located on the back of this car seat as shown.

WARNING:

You **MUST** store the LATCH belt when installing with aircraft belts.

Dorel Juvenile Group, Inc. (DJG) warrants this product to the original retail purchaser as follows: This product is warranted against defective materials or workmanship for one year from the date of original purchase. **An original receipt is required to validate your warranty.** DJG will, at its option, provide replacement parts or replace this product. DJG reserves the right to substitute if the part or model has been discontinued.

To make a claim under this warranty contact our Consumer Care Department by phone at 1-800-951-4113; or text us at 1-812-652-2525. Our hours of operation are from 8:00 a.m. to 6:00 p.m. ET Monday through Thursday and from 8:00 a.m. to 4:30 p.m. on Friday.

Proof of purchase is required and shipping charges are the responsibility of the consumer.

Warranty Limitations: This warranty does not include damages which arise from misuse or abuse of this product.

Limitation of Damages: The warranty and remedies as set forth are exclusive and in lieu of all others, oral or written, expressed or implied. In no event will DJG or the dealer selling this product be liable to you for any damages, including incidental or consequential damages, arising out of the use or inability to use this product.

Limitation of warranties and other warranty terms and state law rights: Any implied warranties, including implied warranties of the merchantability and fitness for a particular purpose, shall be limited to the duration and terms of the express written warranty. Some states do not allow limitations as to how long an implied warranty lasts or the exclusion or limitation of incidental or consequential damages, so the above limitations may not apply to you.

This warranty gives you specific legal rights, and you may have other rights, which vary from state to state. Neither DJG nor the dealer selling this product authorized any person to create for it any other warranty, obligation, or liability in connection with this product.

Please note: Our product warranty only applies when purchased from an authorized Maxi-Cosi retailer. The origin of products not purchased through these authorized retailers is unknown and could be counterfeit. We cannot support products from an unknown origin as we cannot verify the handling or condition of such merchandise. We maintain a strong network of authorized retailers to ensure you are purchasing safe and complete products. Fulfillment by a third party does not guarantee you are purchasing from one of these authorized retailers. Pricing which is inconsistent with the majority of retailers is a strong indication that the retailer is not authorized, as we have a consistent price offering across all authorized retailers. If you are unsure of the authorization status of a retailer you are considering purchasing from, or have purchased from, you can check www.maxicosi.com/us-en/shops.aspx; or call our Consumer Care Department at 1-800-951-4113; or text us at 1-812-652-2525.