

4

3

2

1

[264.60]
10 ²⁷/₆₄"

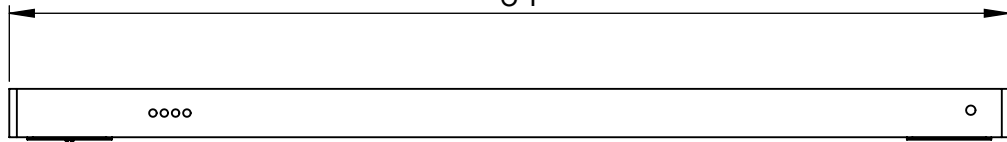

B

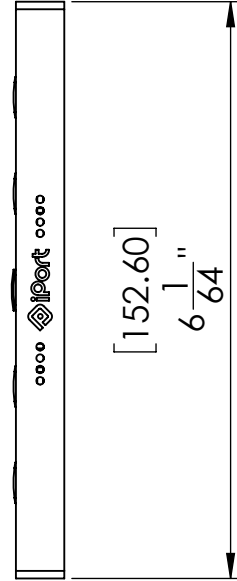
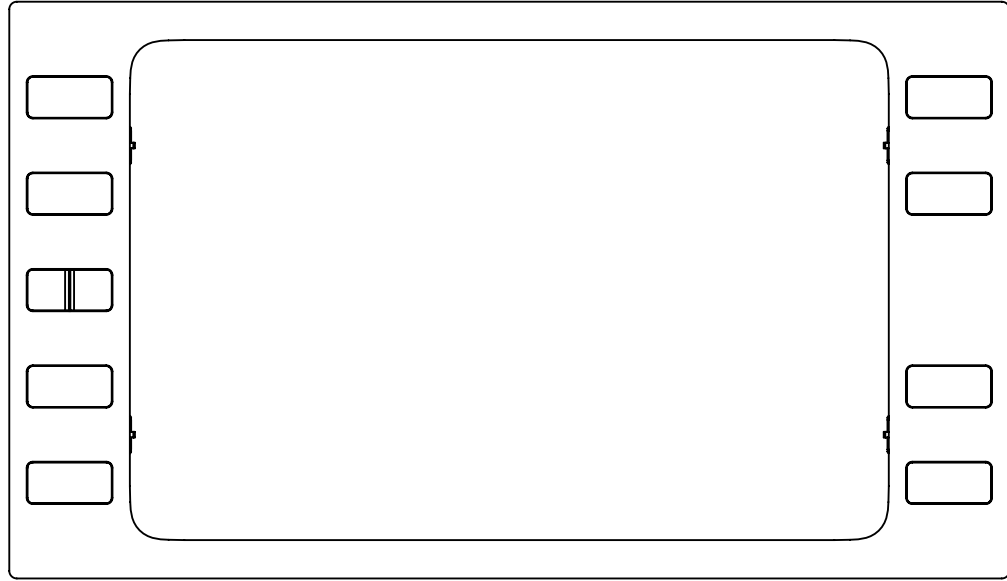

[152.60]
6 ¹/₆₄"

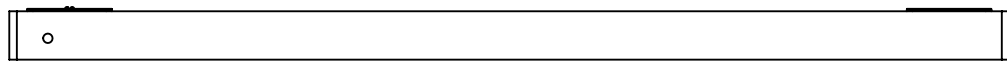

[12.80]
1/2"

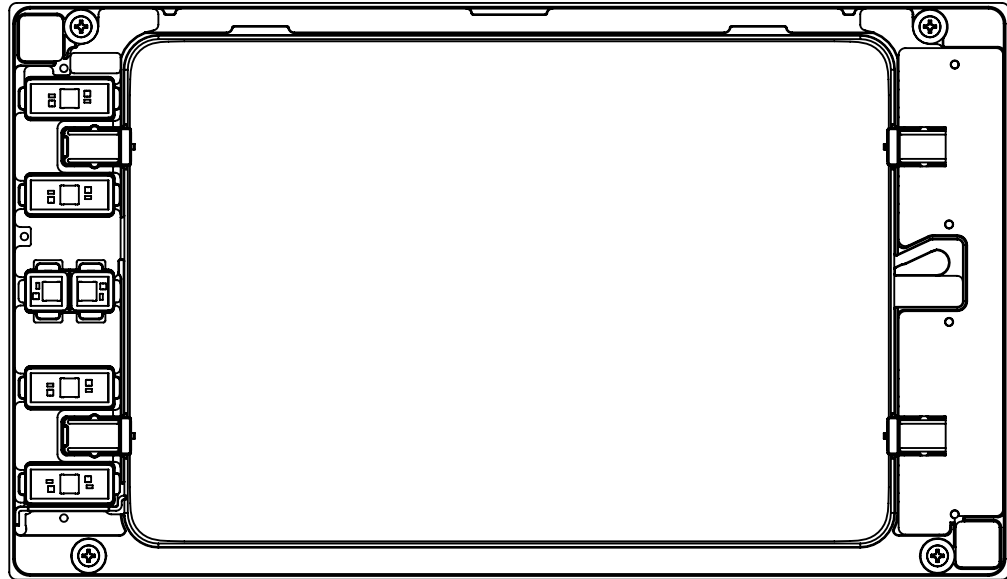

A

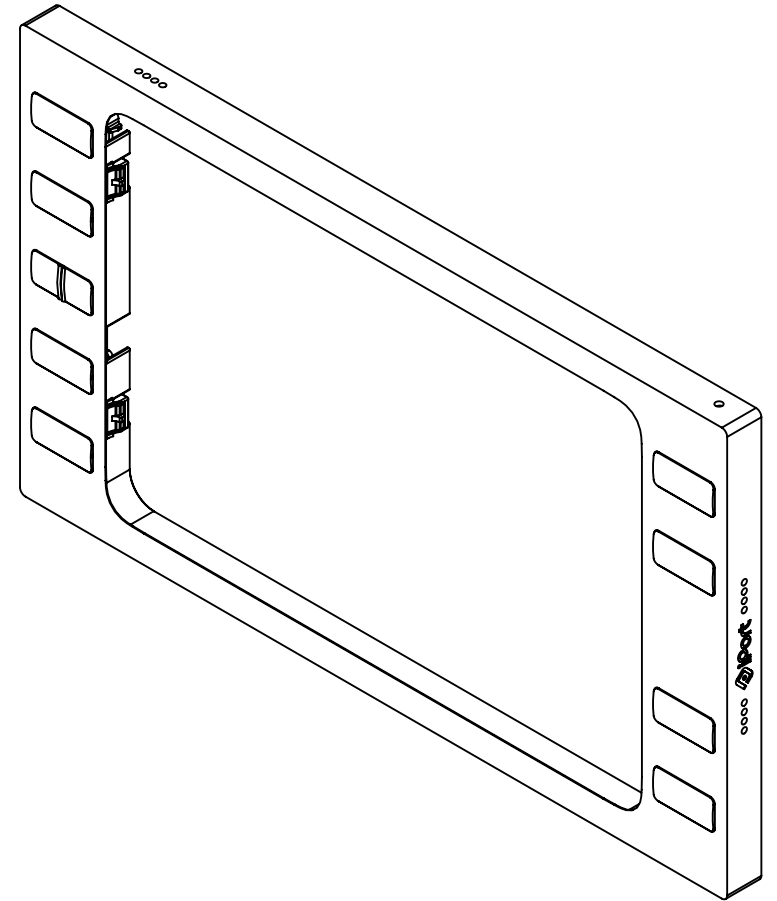

B

A

4

3

2

1

IPORT SURFACE MOUNT MINI 4 BEZEL 10 BUTT

METRIC/INCHES	 a DANA INNOVATIONS COMPANY	
DESIGNED IN SAN CLEMENTE, CALIFORNIA BY IPORT	NAME BEZEL SUBASSY SURFACE MOUNT	
NOTICE OF PROPRIETARY INFORMATION: THE INFORMATION CONTAINED HEREIN IS THE PROPRIETARY PROPERTY OF DANA INNOVATIONS. THE POSSESSOR AGREES TO THE FOLLOWING: 1. TO MAINTAIN THE SECRECY AND CONFIDENTIALITY OF THE INFORMATION CONTAINED HEREIN. 2. NOT TO REPRODUCE, COPY, MIRROR, OR PUBLISH IT. 3. NOT TO REPRODUCE OR PUBLISH IT IN WHOLE OR IN PART. 4. ALL RIGHTS RESERVED.	SIZE IPAD MINI4 10	REV
SCALE: 1:2	WEIGHT:	SHEET 1 OF 1