

88 5177 301C

Round Table

IMPORTANT NOTE

Carefully remove all the parts from the carton and put them individually on a soft cloth to prevent scratches or other damage occurring to the parts.

We have taken great care in the design of this product and request that you carefully and strictly follow our assembly instructions to ensure a completed product as it was designed.

*Home
Styles*

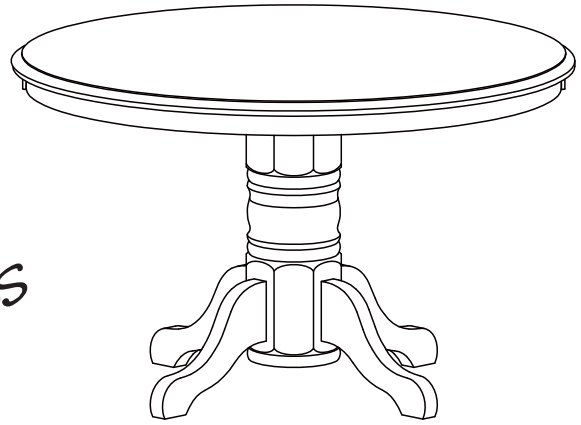

Part List

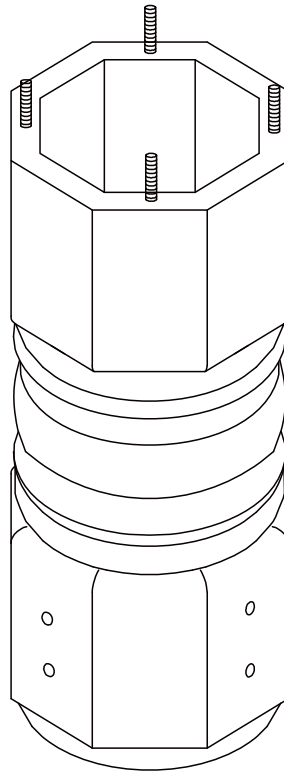

C.
Post
1 pc.

For assembly see instructions in carton 88 5177 302C

88 5177 302C Round Table

IMPORTANT NOTE

Carefully remove all the parts from the carton and put them individually on a soft cloth to prevent scratches or other damage occurring to the parts.

We have taken great care in the design of this product and request that you carefully and strictly follow our assembly instructions to ensure a completed product as it was designed.

*Home
Styles*

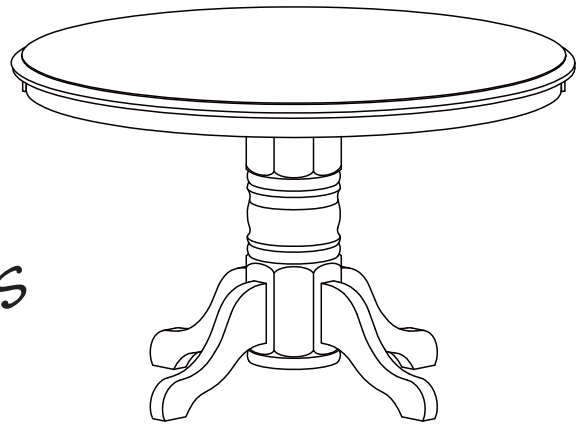

Part List

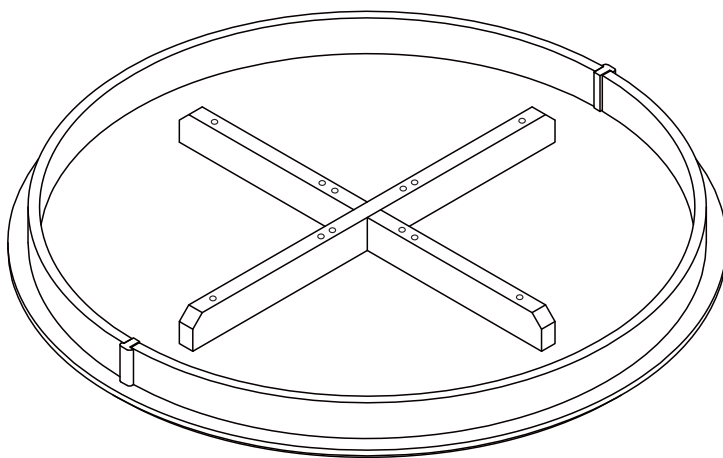

A.
Table Top
1 pc.

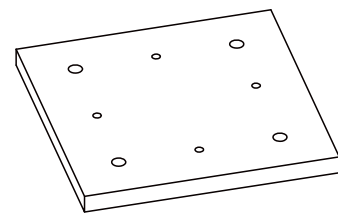

B.
Connector Panel
1 pc.

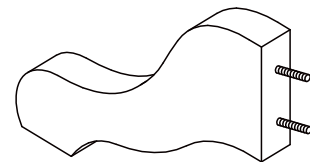

D.
Leg
4 pcs.

Hardware List

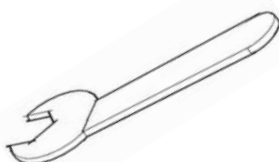

Key Wrench
1 pc.



Hex Wrench
1 pc.



Small Wrench
1 pc.

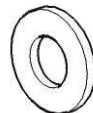

Flat Washer (large)
12 pcs. (+1 extra)



Spring Washer (large)
12 pcs. (+1 extra)



Flat Washer (small)
4 pcs. (+1 extra)



Spring Washer (small)
4 pcs. (+1 extra)



Nut
12 pcs. (+1 extra)

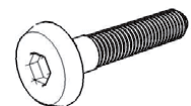

**M6x40
Head Cap Bolt**
4 pcs. (+1 extra)

For assembly also need carton 88 5177 301C

Tools recommended for assembly : Level

Home Styles Consumer Assistance : www.homestyles-furniture.com,
servicedesk@homestyles-furniture.com, 888-680-7460, 877-831-0319

IMPORTANT

- * Please keep Hex Wrench and Key Wrench in a safe place as you may need to tighten up the Head Cap Bolts in the future.
- * Use a soft cloth between these parts and the floor.
- * After assembly, item must be level to work properly. Use the included adjustable levelers to level.

STEP 1

Attach Connect Panel (B) to Post (C) with Flat Washers (large), Spring Washers (large) and Nuts.

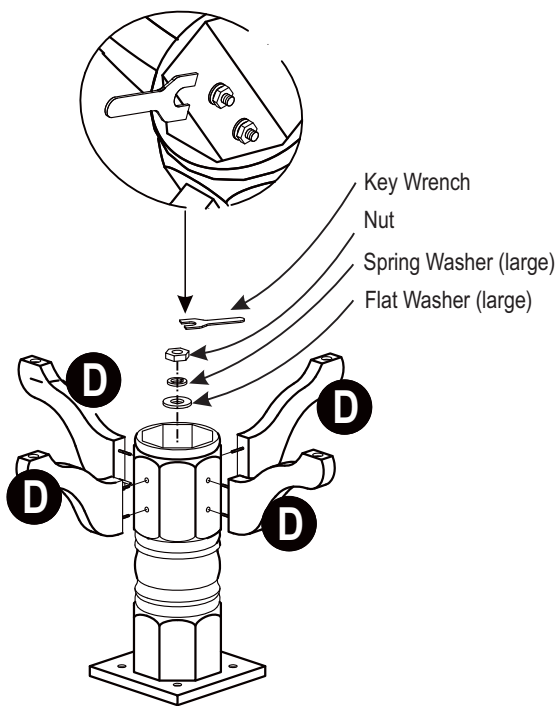
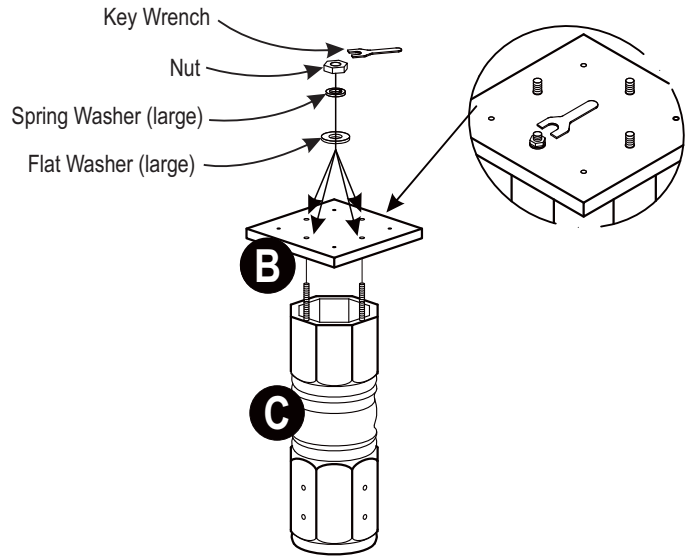

STEP 2

Turn the unit upside down on the soft cloth.

Attach Legs (D) to the unit with Flat Washers (large), Spring Washers (large) and Nuts.

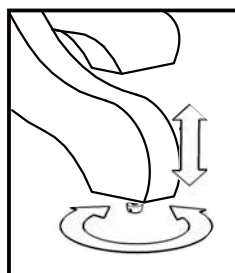

Figure 1

STEP 3

Attach base unit from Step 2 to Table Top (A) with Flat Washers (small), Spring Washers (small) and Head Cap Bolts.

Turn the unit over to its' upright position.

To level the unit, adjust the adjustable levelers on the bottom of unit. (See Figure 1)

