

# ASSEMBLY INSTRUCTION

## NIGHTSTAND

**A** Nightstand

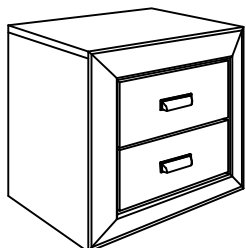

1 pc

**B** Front Right Feet (FR)

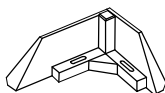

1 pc

**C** Front Left Feet (FL)

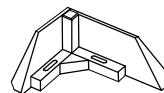

1 pc

**D** Rear Right Feet (BR)

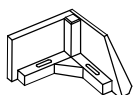

1 pc

**E** Rear Left Feet (BL)

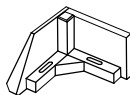

1 pc

**F** JCBC Bolt  
M6 x 35mm



8 pcs

**G** Spring Washer  
Ø1/4"



8 pcs

**H** Flat Washer  
Ø1/4" x 20mm



8 pcs

**I** Allen Key  
M4 x 65mm



1 pc

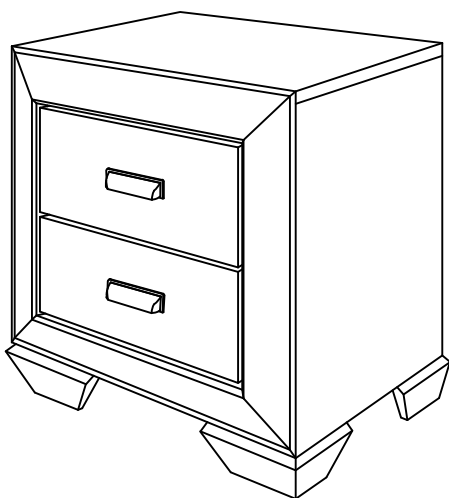

This page lists all the contents included in the box. Please take the time to identify the hardware as well as the individual components to this product. As you unpack and prepare for assembly, place the contents on a carpeted or padded area to protect them from damage.

**IMPORTANT NOTE :**

1. Do not tighten all screws / bolts until all completely assembled.
2. Keep all hardware parts out reach of children.

- 1** Take out Hardware Pack with Feet Packaging from the bottom of Nightstand which marked with the rope while Assembly Instruction sheet is placed at 1<sup>st</sup> drawer.

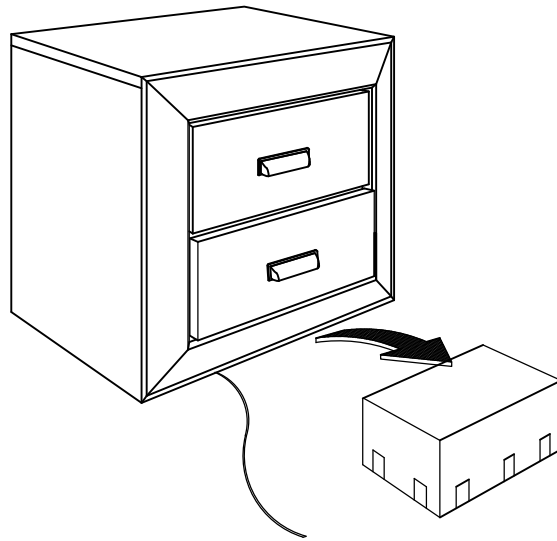

- 2** Align and tighten Front Right Feet (FR) (B), Front Left Feet (FL) (C), Rear Right Feet (BR) (D) and Rear Left Feet (BL) (E) to unit according to the position left and right. Follow the label correctly using JCBC Bolt (F), Spring Washer (G) and Flat Washer (H) and fully tighten with Allen Key (I).

"FR" & "FL" marking at bottom of the unit & top of the leg

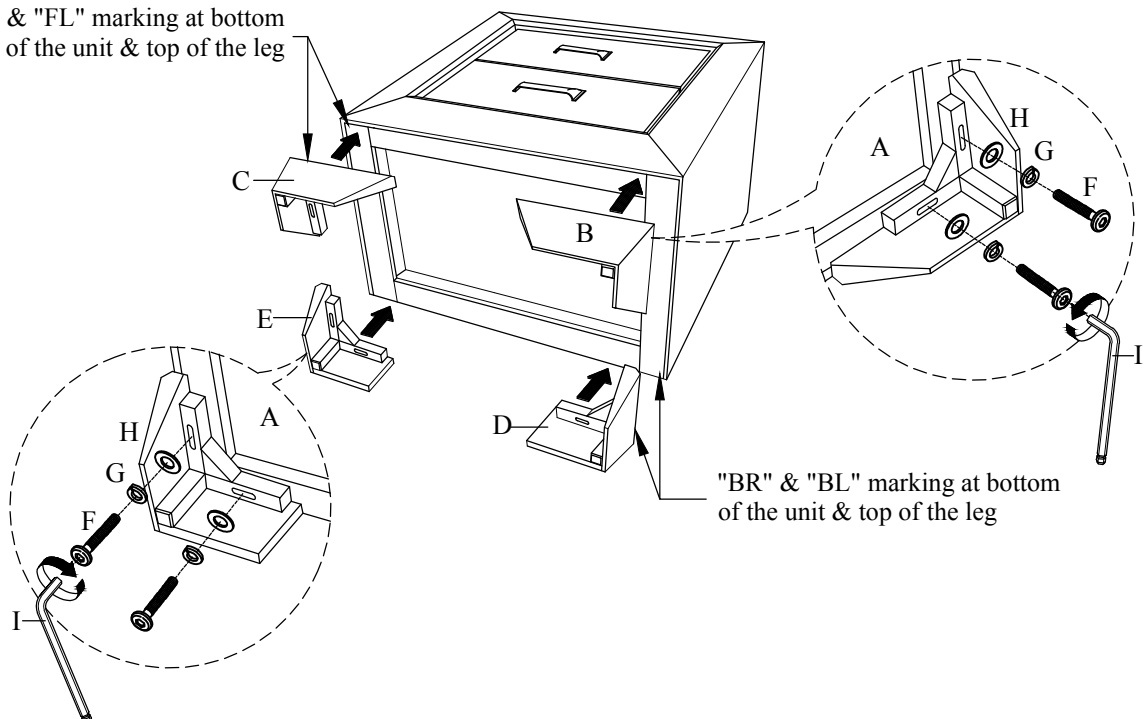

"BR" & "BL" marking at bottom of the unit & top of the leg

#### CLEANING & CARE

Treat surface with care. Surface is resistant to scratches but is not scratch resistant. Clean surfaces with a dry or damp soft cloth. Do not use abrasive cleaners. Hardware may loosen over time. Periodically check that all connections are tight.