

NetShelter™ EIA Adapter Kit 23 in. - 19 in.

AR8150

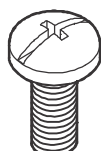

4

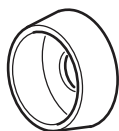

4

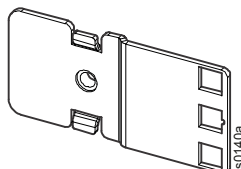

4

ns2140b

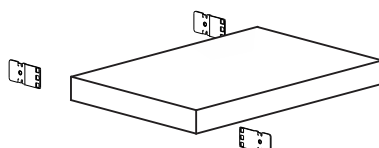
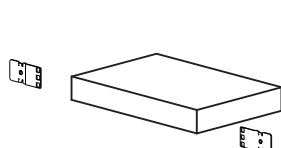
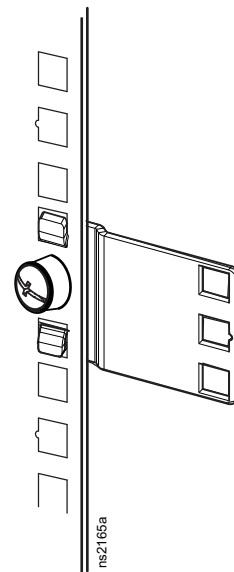
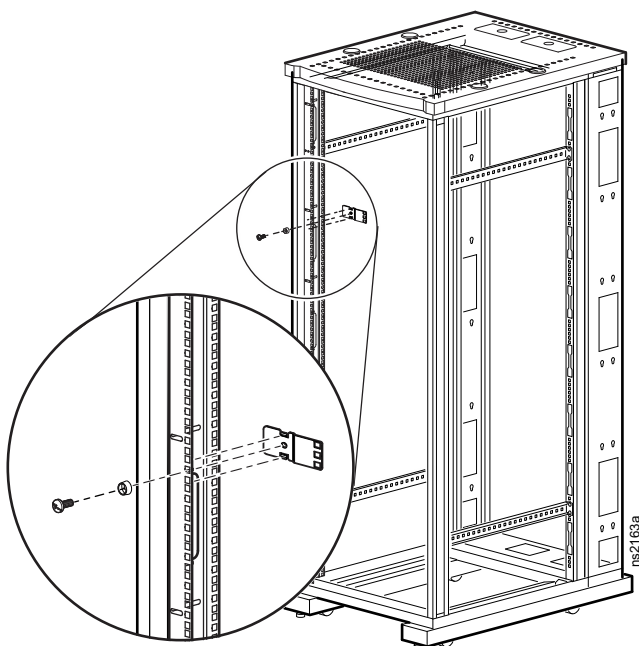

ns2177a

Customer support and warranty information is available at www.schneider-electric.com.