

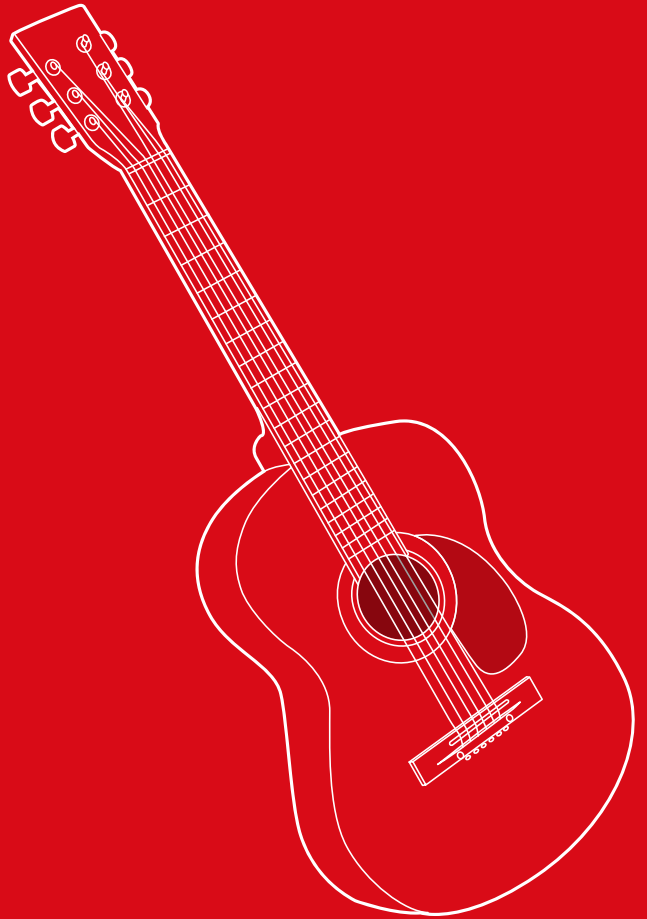

bestchoiceproducts



INSTRUCTION MANUAL

41-Inch Acoustic Guitar Starter Kit

Ver. 5

SKY1080 + SKY5497 + SKY6093 + SKY6094 + SKY6095 + SKY6096



bestchoiceproducts

As shoppers, we're always trying to find the perfect balance between quality & value. At BCP, we believe we've achieved that. Our diverse catalog of everyday essentials is tailored especially to our customers & guaranteed to hit that sweet spot of high quality & low price.

— Always. —

TOOLS REQUIRED



ALLEN WRENCH
(PROVIDED)



3V CR2032
BATTERY

PARTS

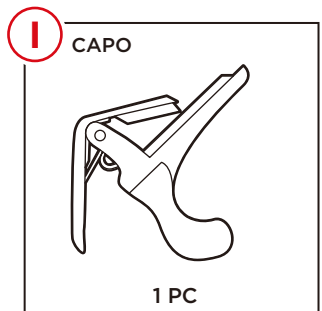
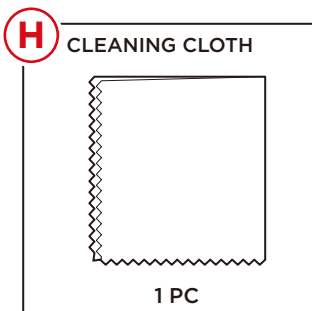
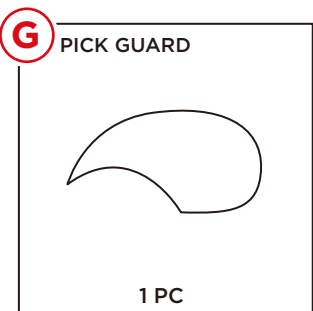
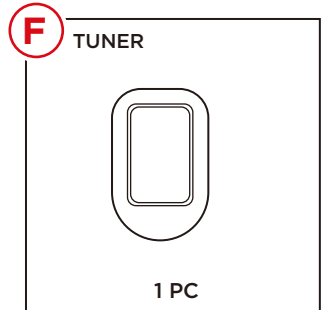
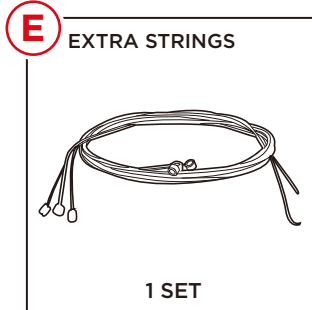
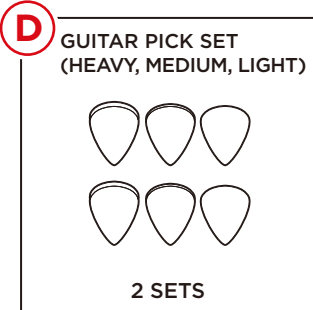
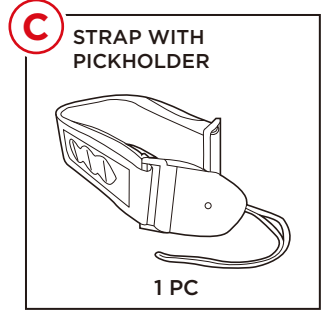
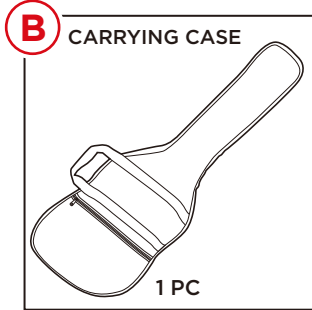
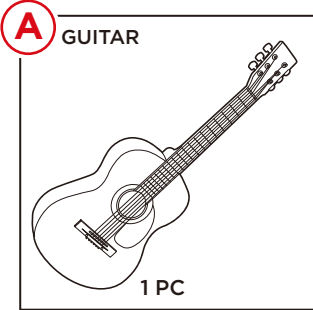

DIAGRAM

Please retain these instructions for future reference.

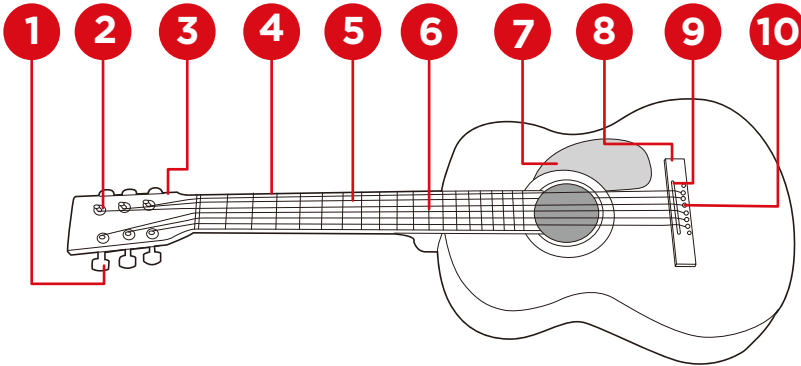

- | | |
|-------------------|--|
| 1. Tuning Pegs | 7. Pick Guard: Remove backing and adhere part G pick guard |
| 2. Tuning Machine | 8. Bridge |
| 3. Headstock/Head | 9. Saddle |
| 4. Neck | 10. Bridge Pins |
| 5. String | |
| 6. Fret | |

TUNING STRINGS

1. Install a 3V CR2032 battery in the part F tuner. Attach the tuner to the headstock of the guitar.
2. Turn tuner on and tune the guitar strings accordingly.
 - Standard tuning is as follows (low to high): E, A, D, G, B, E

GUITAR STRING MAINTENANCE

If strings are difficult to play or do not play correctly:

Replacing guitar strings can remedy many problems involving poor sound. All strings can be changed at once or strings can be changed individually. To change a guitar string, the old string should be completely removed before attaching the new string. After the new string is attached, the guitar will need to be re-tuned.

CHANGING STRINGS

Removing Old Strings:

1. To remove a guitar string, find the tuning peg and tuning machine that the string is attached to. Loosen the string by winding the tuning peg until the string has no tension.
2. Continue to wind the string loose until the string can be pulled loose from the top. The strings can be pulled out via the bridge at the bottom of the guitar.
3. If you do not wish to use the old string again, you can cut the string near the middle of the strings via wire cutters. If you choose to do this, be careful and hold the string securely next to the cut; otherwise, the string will pop up and can potentially harm you.

CHANGING STRINGS

Installing New Strings:

1. Remove the bridge pin of your guitar. Bridge pins can stick to the guitar, and may take some time to get off; the edge of a peg winder (available at any local music store) can be used to help. Locate the proper string to replace your old string. Then, from the end of the string that does NOT have a ball at the end, feed the string through the bridge via the open hole exposed by removing the pin. Then, press the bridge pin back into place gently with the slot facing forward, and while holding your finger on the pin, run the string through until the ball on the end of the string is flush to the bottom of the pin.

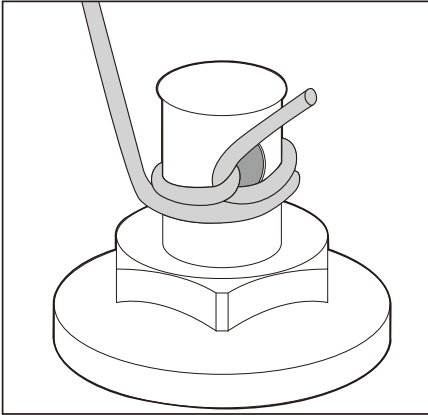

2. Secure the string to the headstock via the tuning machine. To do so, make sure the eye/hole of the tuning machine is parallel to the neck/headstock of the guitar. Feed the string through the eye of the tuning machine and pull the string fairly taut. The string should have a bit of slack (about 1-2 inches).
3. While holding the string taut, secure it to the tuning machine by turning the corresponding tuning peg to wrap the string around. For extra security, route the string through itself on the initial wrap around (see diagram).
 - For treble strings (G,B,E), wind the strings clockwise. For bass strings (E, A, D), wind the strings counter-clockwise.
4. Begin to tune the string by winding the tuning peg until the desired sound is produced. After reaching the desired tone, pull the string lightly. The string will go slightly out of tune. Readjust the tuning peg until receiving the desired tone again. Repeat the process a few more times. This will ensure that your string will stay in tune while playing.
5. You may cut off the excess string, but it is important to leave some excess still attached (about ¼-1 inch) in case the guitar string needs to be restrung again. Remember, it is easy to cut more off later, but impossible to add string back.

GUITAR CARE

Dust and other foreign matter can harm the quality of your guitar. Make sure to regularly clean and maintain your guitar, including around the tuning pegs and bridge. To clean your guitar, use a dry, soft cloth. If desired, guitar polish can be bought from any local music store. Do not leave your guitar exposed to the sunlight or elements, and be aware that guitars are made of wood and are therefore sensitive to changes in temperature, humidity, and altitude.

ADJUST NECK TENSION

1. Locate the tension rod on the base of the neck under the strings.
2. Use Allen wrench to loosen/tighten the tension of the guitar neck.

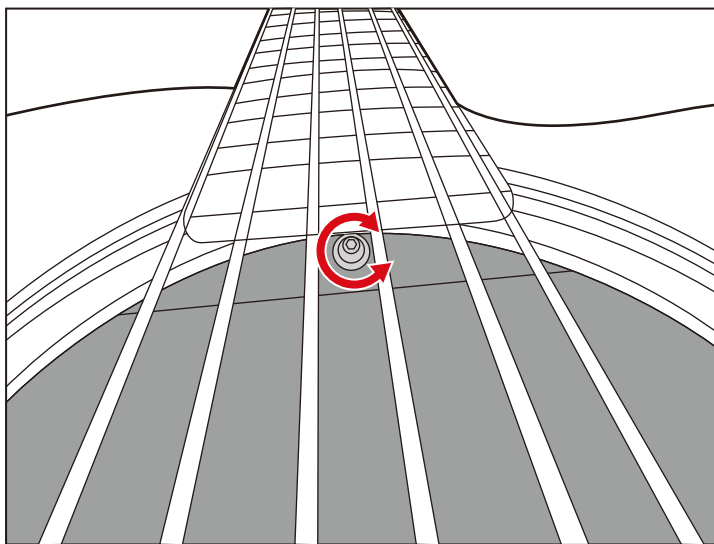

CAPO

Place on different frets to play in different keys/tunings.

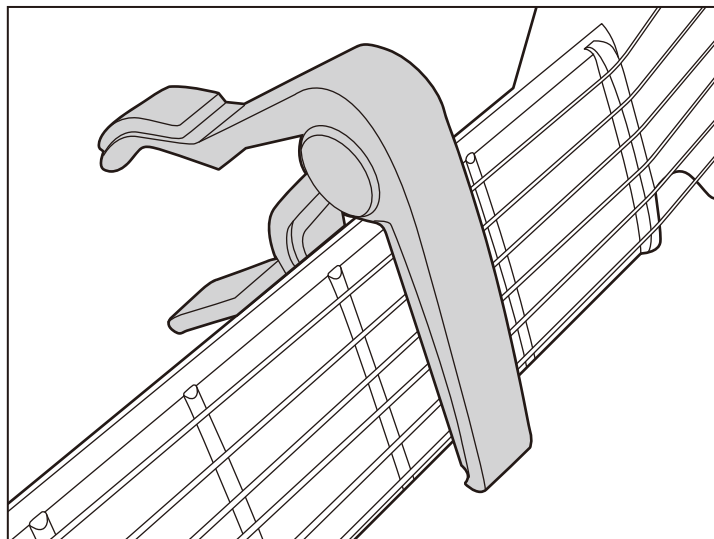

Earn points while you shop. Join today!

bestchoiceproducts
rewards

Join | Earn | Redeem

Give your friends 15% off their first order! For each successful referral you'll receive 100 points.

bestchoiceproducts.com



HELP CENTER



Question about your product? We're here to help. Visit us at:

help.bestchoiceproducts.com



Chat Support



Product Inquiry



Orders FAQ



Product Assembly



Returns & Refunds

PRODUCT WARRANTY INFORMATION

All items can be returned for any reason within 60 days of the receipt and will receive a full refund as long as the item is returned in its original product packaging and all accessories from its original shipment are included. All returned items will receive a full refund back to the original payment method. All returned items will not be charged a re-stocking fee.

All returned items require an RA (Return Authorization) number, which can only be provided by a Best Choice Products Customer Service Representative when the return request is submitted. Items received without an RA may not be accepted or may increase your return processing time. Once an item has been received by Best Choice Products, refunds or replacements will be processed within 5 business days.

All returns must be shipped back to the Best Choice Products Return Center at the customer's expense. If the reason for return is a result of an error by Best Choice Products then Best Choice Products will provide a pre-paid shipping label via email. Boxes for return shipping will not be provided by Best Choice Products, and is the customer's responsibility to either use the original shipping boxes or purchase new boxes.

Pictures may be required for some returns to ensure an item is not damaged prior to its return. Items returned are not considered undamaged until they are received by Best Choice Products and verified as such. All damages to items are the customer's responsibility until the item has been received by and acknowledge by Best Choice Products as undamaged.



WARNING

Manufacturer and seller expressly disclaim any and all liability for personal injury, property damage or loss, whether direct, indirect, or incidental, resulting from the incorrect attachment, improper use, inadequate maintenance, unapproved modification, or neglect of this product.