



BEST CHOICE
PRODUCTS



INSTRUCTION MANUAL

Hanging Chaise Lounge Chair

SKY1831 + SKY5871 + SKY5872 + SKY5873 + SKY6579 + SKY6580
SKY6668

! NOTICE

Please retain these instructions for future reference.

- Do not stand on or use any part of this product as a step ladder.
- Firmly secure all bolts, screws and knobs before use.
- Reconfirm that all bolts, screws, and knobs are secure every 90 days.
- Do not use or store this item in the proximity of open flame or flammable/combustible chemicals.
- If any parts are missing, broken, damaged, or worn, stop using this product until repairs are made and/or factory replacement parts are installed.
- Do not use this item in a way inconsistent with the manufacturer's instructions as this could void the product warranty.
- This product is intended for residential use only.

! WARNING

To prevent potential injury, please do not enter from the front of the seat; enter from the side.

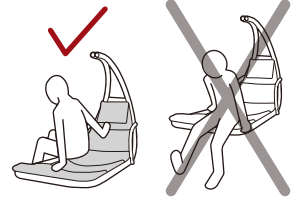

TOOLS REQUIRED



ALLEN WRENCH
(2, PROVIDED)



WRENCH
(2, PROVIDED)



265 LBS
CAPACITY



1 PERSON
ASSEMBLY



UP TO 60 MIN.
ASSEMBLY

HARDWARE

1 M10 x 100mm
BOLT



1 PC

2 M10 x 80mm
BOLT



1 PC

3 M8 x 70mm
BOLT



1 PC

4 M8 x 75mm
BOLT



4 PCS

5 M8 x 50mm
BOLT



4 PCS

6 M8 x 20mm
BOLT



2 PCS

7 CARABINER
HOOK



1 PC

8 S-HOOK



1 PC

9 ROPE



1 PC

10 EYE BOLT



1 PC

PARTS

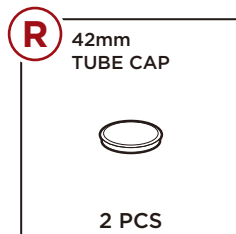
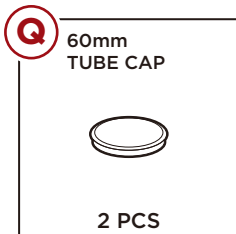
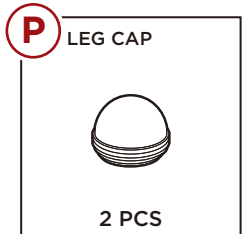
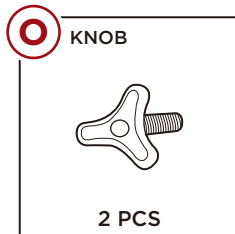
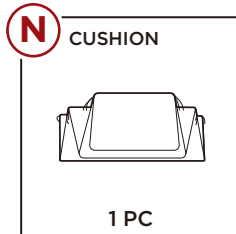
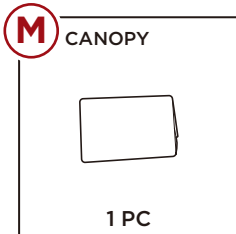
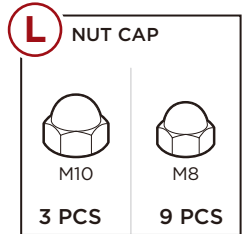
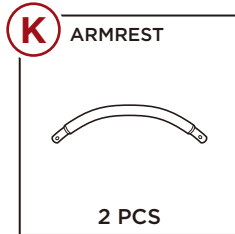
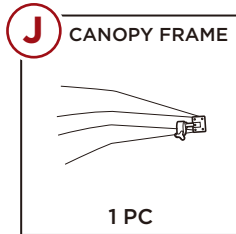
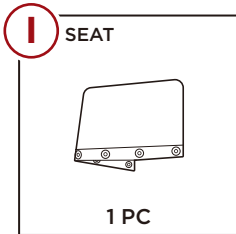
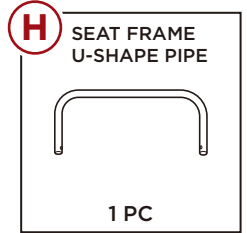
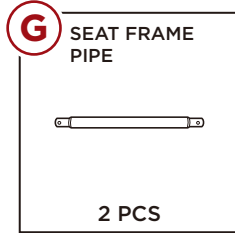
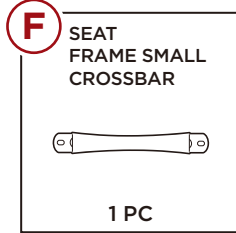
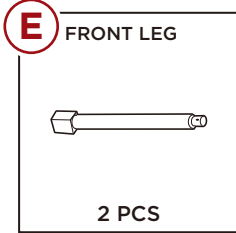
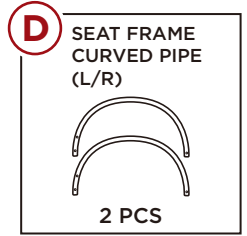
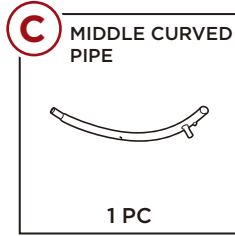
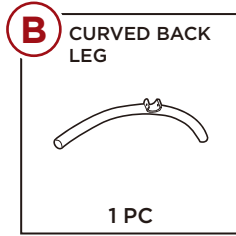
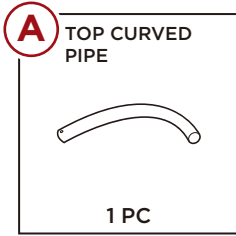

PRODUCT ASSEMBLY

1

Use a wrench to attach the **part 10 eye bolt set** to the **part A top curved bar**. Before proceeding, it is critical that the lock nut is fully engaged onto the eye bolt; turn the bolt past the **blue mark** inside the nut to secure.

Use the **part L nut caps** to cover any exposed hardware.

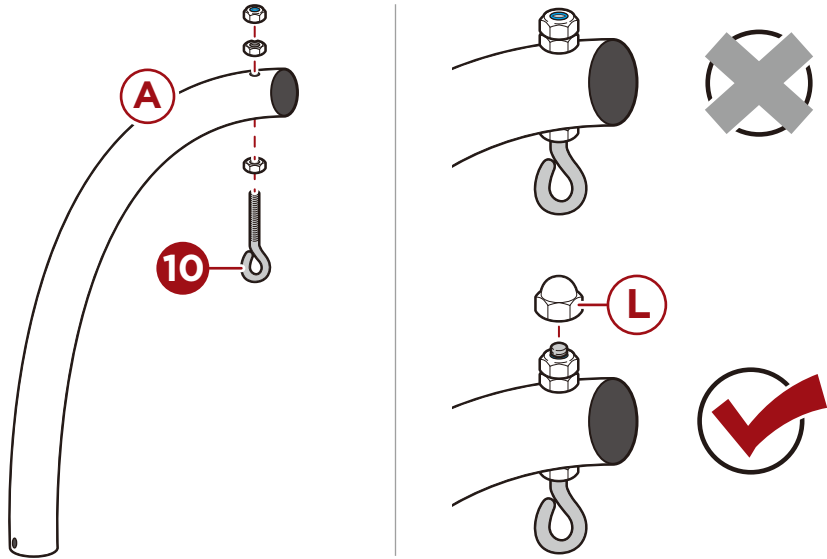

2

Attach the **part J canopy frame** to the **part A top curved bar** with the attached knob.

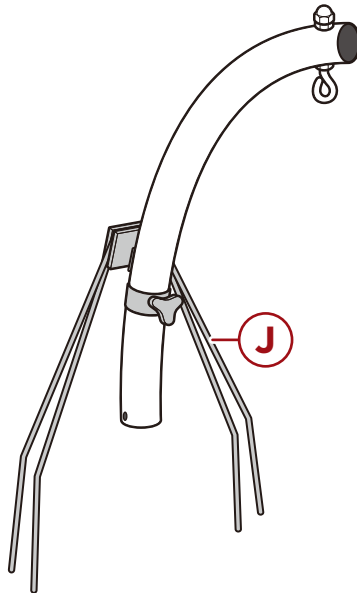

PRODUCT ASSEMBLY

3

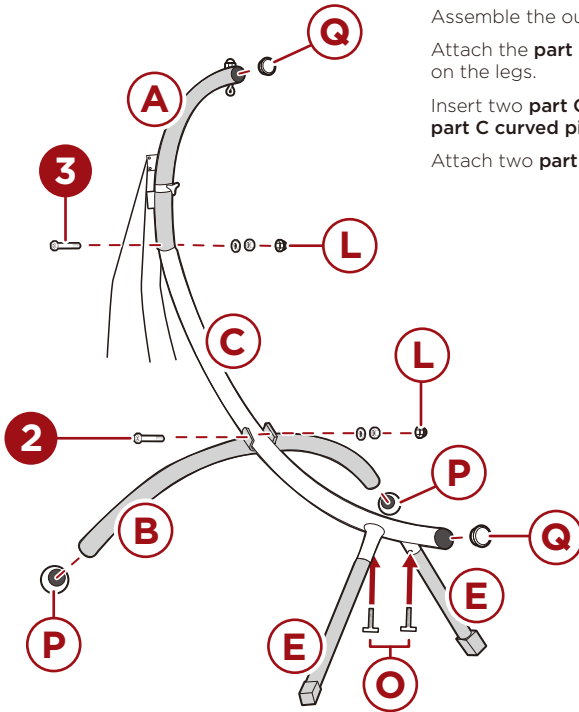

Assemble the outer frame.

Attach the **part E** legs with the knobs provided on the legs.

Insert two **part Q** end caps into the **part A** and **part C** curved pipes.

Attach two **part P** leg caps to the **part B** leg.

4

Place **part 8** between the two **part D** seat frame curved pipes and secure with the **part 1** bolt set. Hook **part 7** to **part 8** as shown. Place a **part L** nut cap over the exposed nut and insert two **part R** end caps into the **part D** frame pipes.

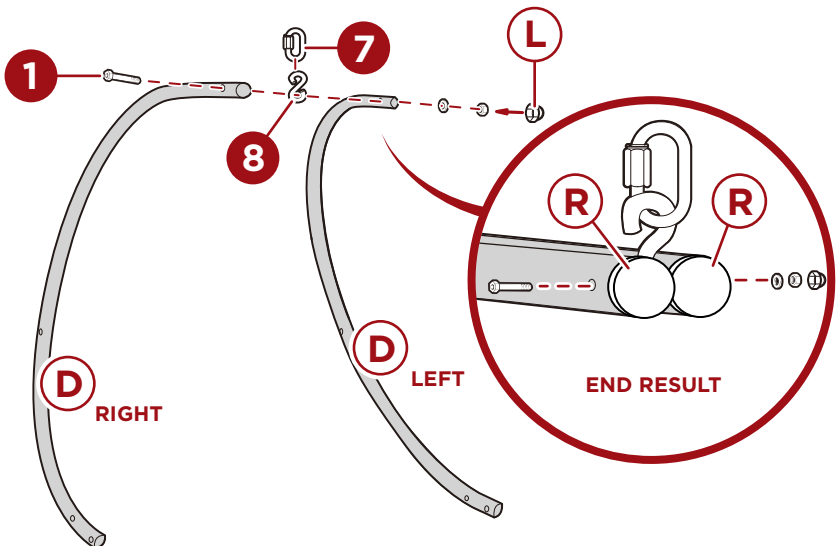

PRODUCT ASSEMBLY

5

Assemble the seat frame.

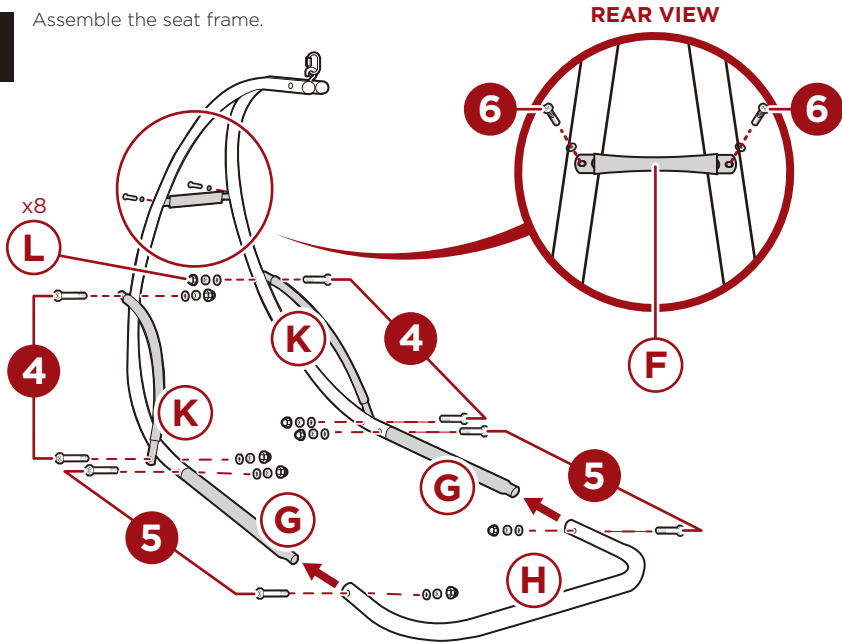

6

Lay the **part I seat** inside the seat frame.

Using the **part 9 rope**, tie a firm knot joining the frame and seat together. Continue weaving the rope in and out until the entire seat is attached, making sure the rope is pulled tight and snug.

Tie several firm knots to secure the seat.

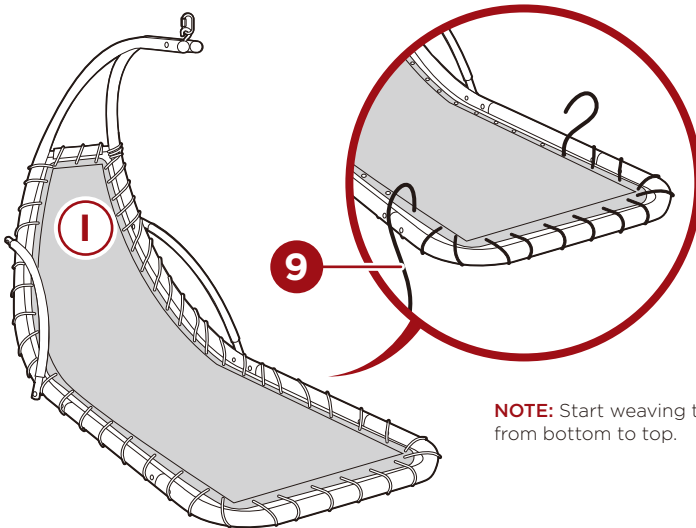

NOTE: Start weaving the rope from bottom to top.

PRODUCT ASSEMBLY

7

Secure the **part M canopy** onto the **part J canopy frame**.

Use the carabiner to hang the seat frame from the outer frame.

Tie the **part N cushion** to the seat frame.

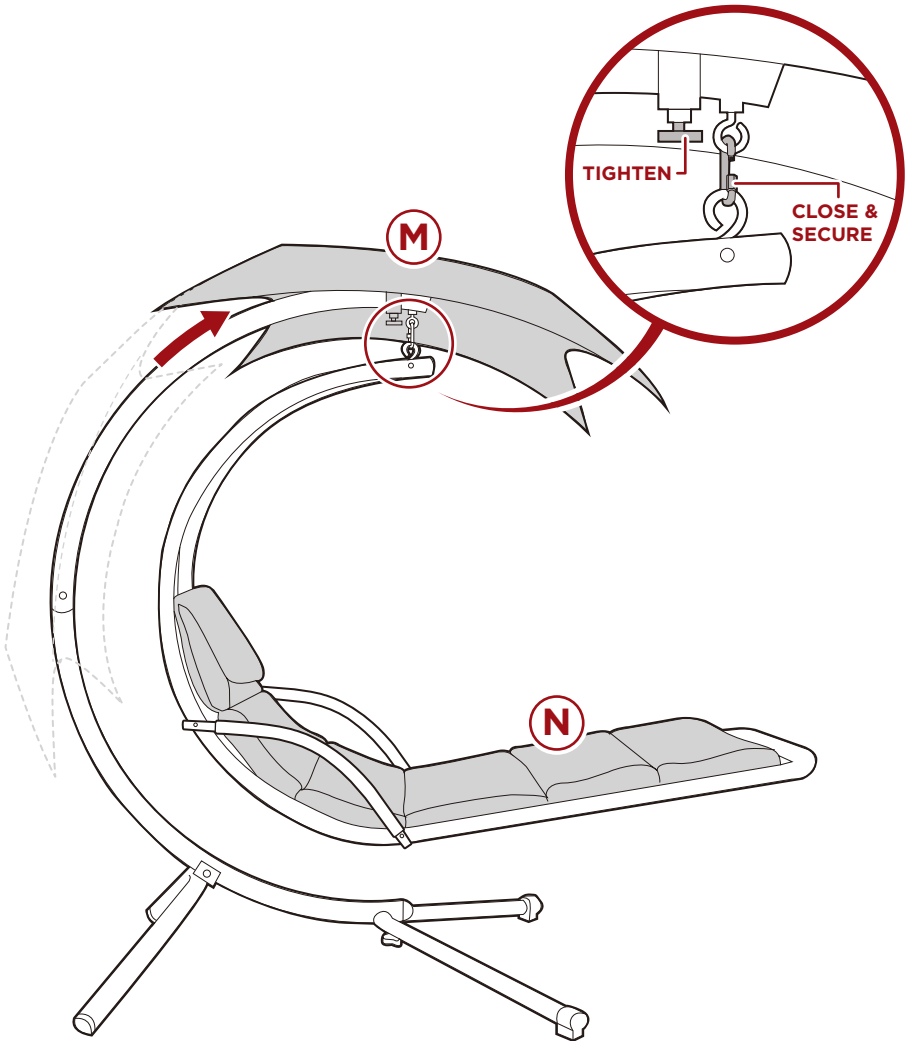



HELP CENTER



Question about your product? We're here to help. Visit us at:

help.bestchoiceproducts.com



Chat Support



Product Inquiry



Orders FAQ



Product Assembly



Returns & Refunds

PRODUCT WARRANTY INFORMATION

All items can be returned for any reason within 60 days of the receipt and will receive a full refund as long as the item is returned in its original product packaging and all accessories from its original shipment are included. All returned items will receive a full refund back to the original payment method. All returned items will not be charged a re-stocking fee.

All returned items require an RA (Return Authorization) number, which can only be provided by a Best Choice Products Customer Service Representative when the return request is submitted. Items received without an RA may not be accepted or may increase your return processing time. Once an item has been received by Best Choice Products, refunds or replacements will be processed within 5 business days.

All returns must be shipped back to the Best Choice Products Return Center at the customer's expense. If the reason for return is a result of an error by Best Choice Products then Best Choice Products will provide a pre-paid shipping label via email. Boxes for return shipping will not be provided by Best Choice Products, and is the customer's responsibility to either use the original shipping boxes or purchase new boxes.

Pictures may be required for some returns to ensure an item is not damaged prior to its return. Items returned are not considered undamaged until they are received by Best Choice Products and verified as such. All damages to items are the customer's responsibility until the item has been received by and acknowledge by Best Choice Products as undamaged.

WARNING

Manufacturer and seller expressly disclaim any and all liability for personal injury, property damage or loss, whether direct, indirect, or incidental, resulting from the incorrect attachment, improper use, inadequate maintenance, unapproved modification, or neglect of this product.