

CYRUS UPH MTL SIDE CHAIR ASSEMBLY INSTRUCTIONS

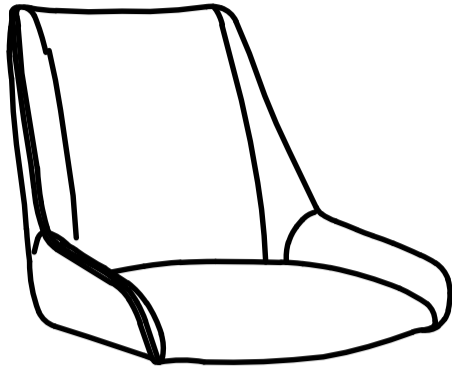

PARTS PACKING CONFIGURATIONS

A. SEAT 2 PCS



B. LEFT LEG 2 PCS

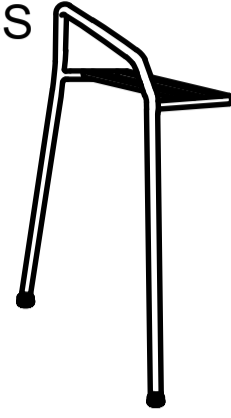

C. RIGHT LEG 2 PCS

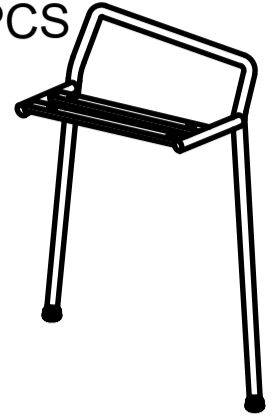

HARDWARE KIT PACKED IN BOX (For 2 pcs chairs)

NO.	DESCRIPTION	IMAGE	Q'TY
1	ALLEN BOLT (M6x35mm)		16 PCS
2	SPRING WASHER (M6)		16 PCS
3	FLAT WASHER (M6)		16 PCS
4	ALLEN KEY (M4)		2 PCS

FULLY ASSEMBLED

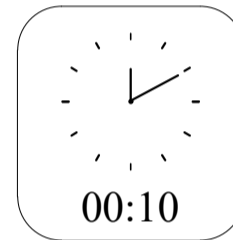
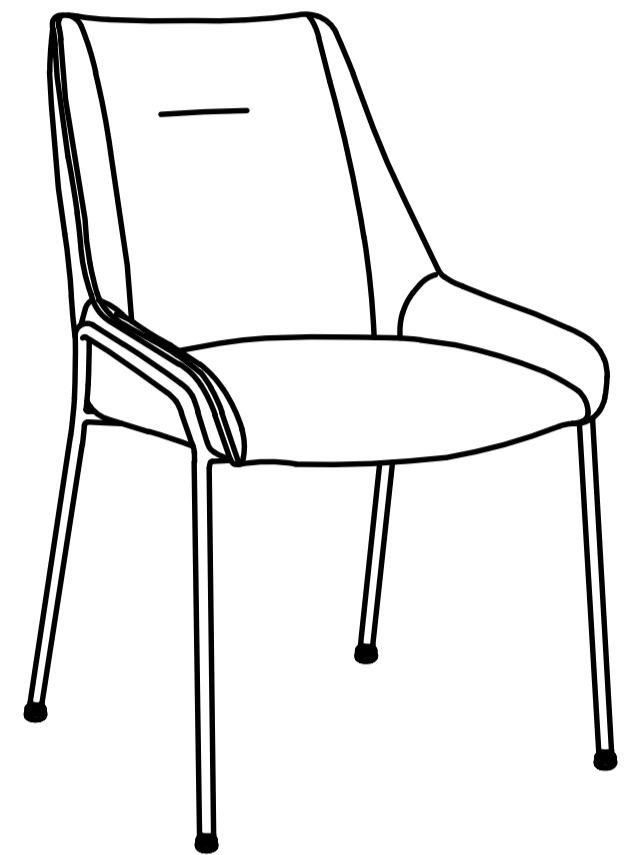

STEP 1:

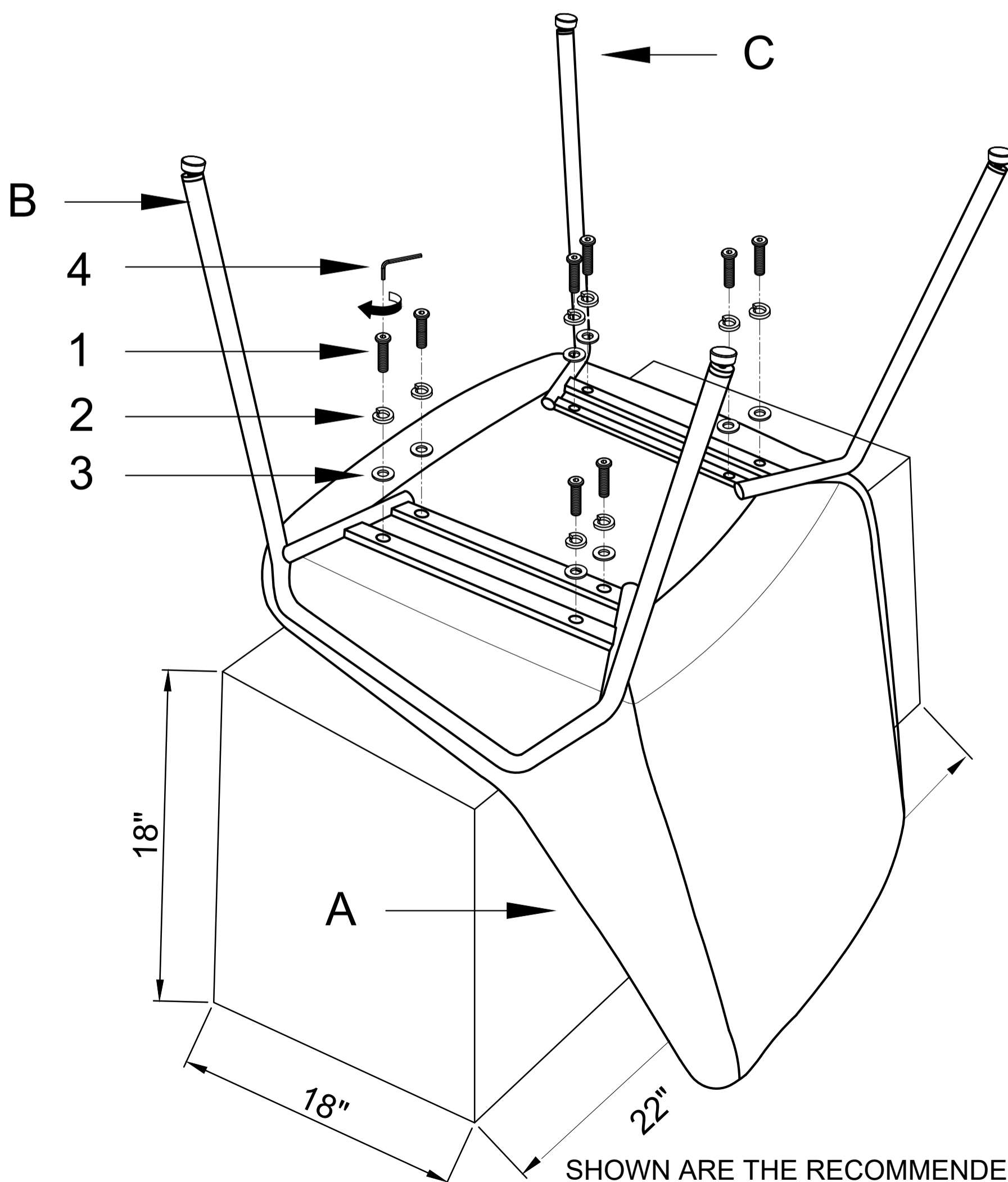

SHOWN ARE THE RECOMMENDED CHAIR SUPPORT DIMENSIONS FOR EASE OF LEG ASSEMBLY.

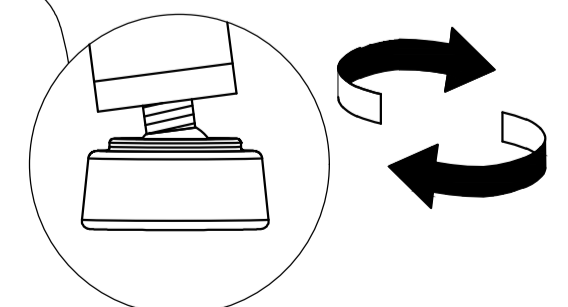
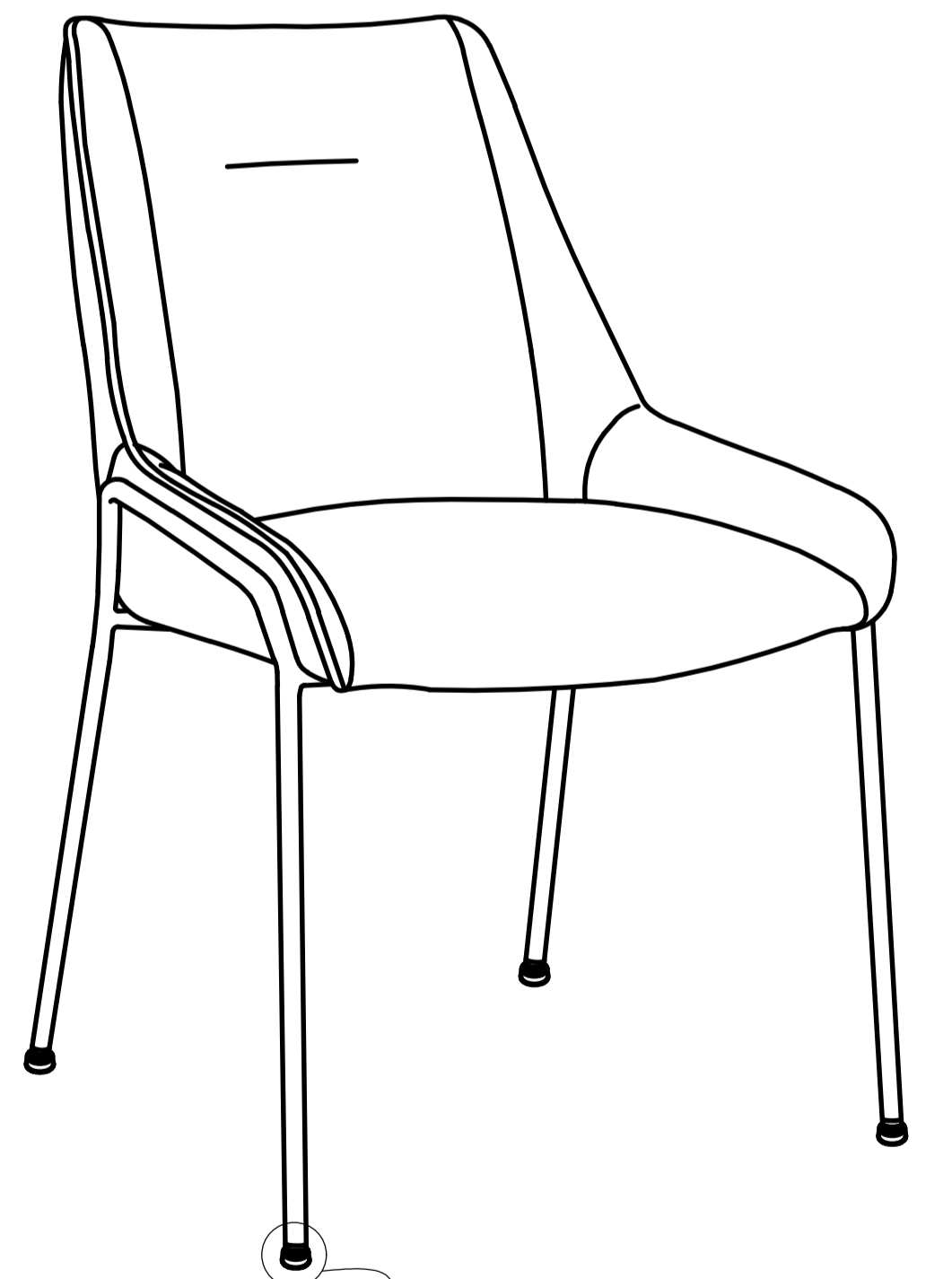

ASSEMBLY COMPLETE