



XOGRILL32XLT2

PERFORMANCE XLT2 32" GRILL HEAD

PUT SOME AWESOME IN YOUR BACKYARD



XOGRILL32XLT2

Family. Good friends. Great food. The sizzle and sear of your XO grill on a warm summer evening. These are the building blocks of memories. That's why our premium appliance experience and the learning from over 25 years of working with customers has gone into the design of every XO grill.

- 51,000 BTUS of Awesome Power
 - (3) Heavy Duty Tubular Stainless Steel Burners
 - Full coverage stainless steel flame tamer plates protect burners and add flavor
- Reliable Flame Thrower Ignition (ignites without electricity)
- Brilliant interior Halogen lighting
- Blue LEDs illuminate the controls and dramatically accent your entertaining
- Easy to read temperature gauge
- Spring Top Lid Opens Effortlessly
- InfraRed rear burner for use with optional rotisserie
- Generous capacity - 702 sq. inches of cooking surface (530 primary, 172 secondary)
- Cooking Zones with removable dividers enable different temperatures side by side
- Heavy duty, stainless steel grates hold the heat for strong grill marks
- Top rack provides baking and roasting area - swings up when not in use

WORLD CLASS SERVICE | COMPREHENSIVE WARRANTIES
OUR LASTING COMMITMENT TO YOU

XOGRILL32XLT2

PERFORMANCE XLT2 32" GRILL HEAD

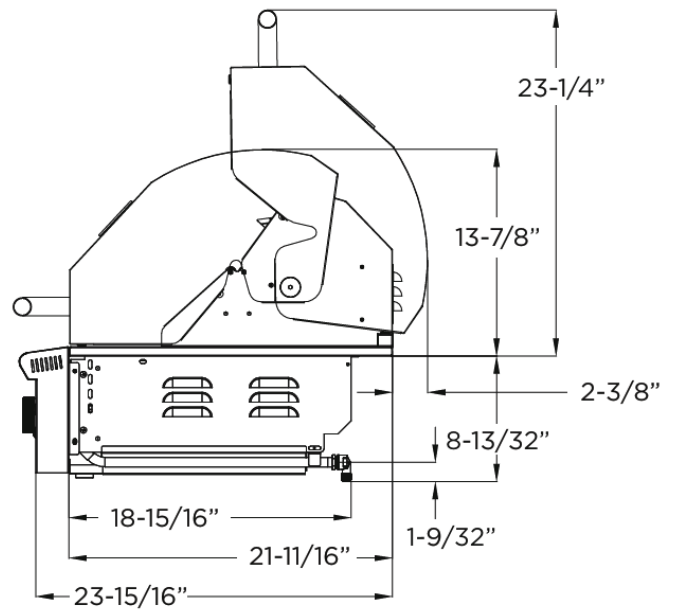
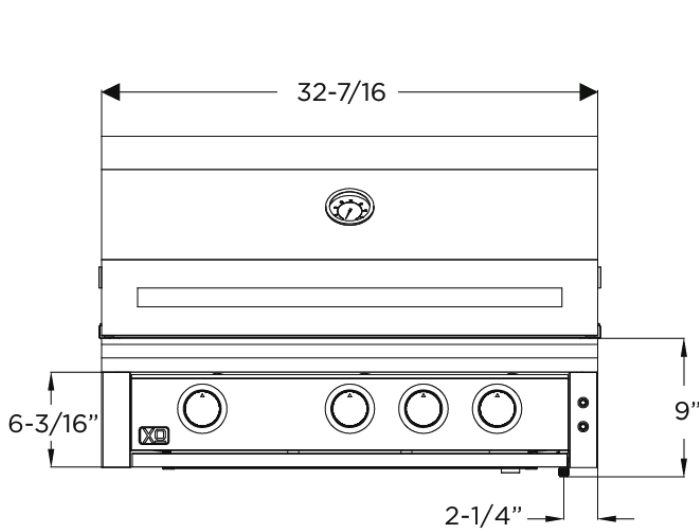

BUILD-IN CUT OUT

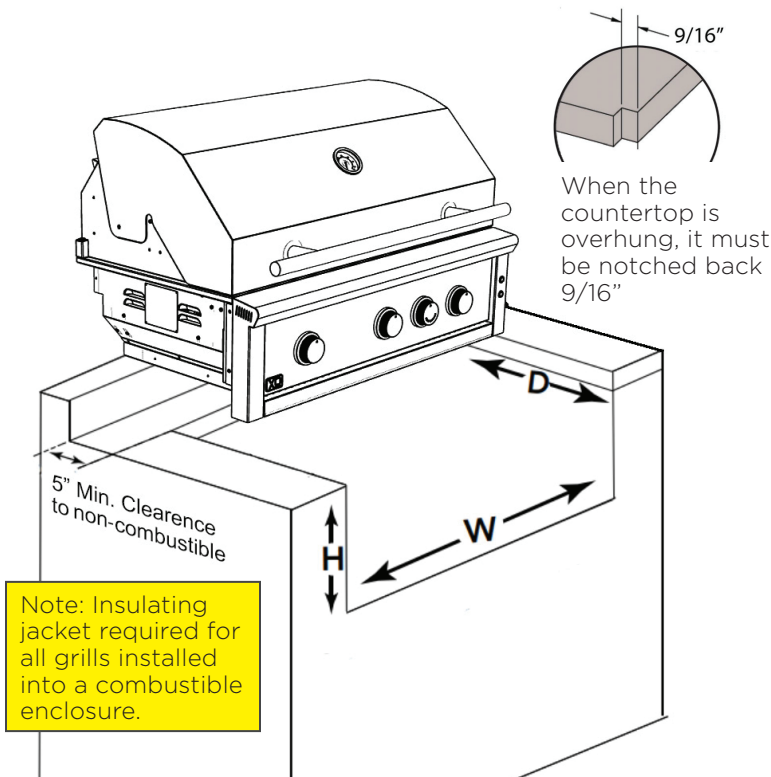

Note: Insulating jacket required for all grills installed into a combustible enclosure.

BUILT IN GRILL CUT OUT DIMENSIONS

	Width = W	Height = H	Depth = D
XOGRILL32XLT	30 5/8"	8 1/2"	21 1/4"
XOGRILL32XLT w/Insulated Jacket	33 1/2"	9 1/2"	21 7/8"

SPECIFICATIONS

SIZE 32"

DIMS 32-7/16"W x 23-15/16"D x 22-9/32"H

INSTALLATION TYPE Built-in or Freestanding with optional cart

FUEL

Specify Natural Gas or Propane. For NG, XO recommends using 3/4" gas lines.

BURNERS

(3) Heavy Duty Tubular SS Burners each burner delivers up to 17,000 BTUs & combine to provide **51,000 BTUs of power!**

GRILLING SURFACE (SQ.IN.)

Primary	Secondary	Total
530	172	702

ELECTRICAL

Installation requires an outdoor 120v GFI electrical outlet adjacent to product

OPTIONAL ACCESSORIES

Insulated Jacket: **XOG32JACKETXLT**
 Infrared Ceramic Burner: **XOGIRXLT**
 40" Built-in Cover: **XOGCOVER32XLT**

POPULAR PERFORMANCE XLT2 GRILL OPTIONS

FULLY APPOINTED AND FEATURED MATCHING CARTS

With sturdy fold down side shelves, heavy duty locking casters, and interior shelf crafted from matching stainless steel.



XOG32CARTXLT2

ACCESS / STORAGE FOR BUILT-IN

Beautifully crafted stainless steel double doors or door/drawer combo units designed to fit perfectly below your grill.



XOG32DDXLT



XOG32COMBOXLT

XO Infrared Ceramic Burners

XO Infrared Burners deliver powerful, rust-proof ceramic heat with an exceptional temperature range—from an intense 1,000°F+ sear down to a gentle 400°F for precise, low-temperature cooking.



XOGIRXLT



XOG32JACKETXLT

INSULATED LINERS

Stainless steel insulated jackets are available for all XO gas fired appliances for use when combustible materials are used in the construction of your outdoor kitchen.

ROTISSERIE KIT

Take maximum advantage of your rear IR burner. Includes an outdoor rated motor, spit, poultry forks, and counterweight - everything you need to slow roast.

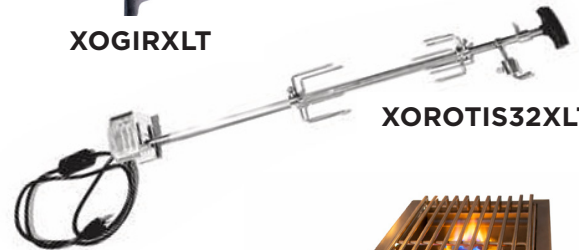

XOROTIS32XLT

TWIN SIDE BURNER

Designed to complement your grill and expand your cooking options, crafted in stainless steel, these two independently controlled 12,000 BTU burners will greatly expand your outdoor cooking options.

XOGSIDEBXLT



ALL WEATHER COVER

Protect your invest with an all weather cover designed for a perfect fit.



XOGCOVER32FS



XOGCOVER32BI

XOGRILL32XLT2 PRODUCT FEATURES

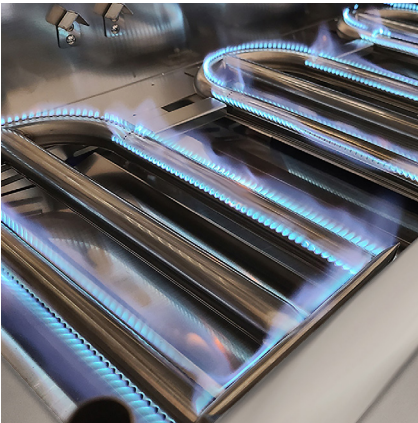

WELDED STAINLESS

BUILT TO LAST - SEAMLESS WELDED AND POLISHED STAINLESS STEEL CONSTRUCTION



STAINLESS STEEL BURNERS

LIFETIME WARRANTIED HEAVY DUTY TUBULAR STAINLESS STEEL BURNERS DELIVER 17,000 BTUs EACH

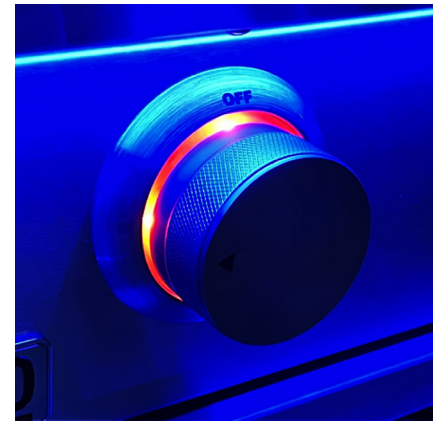

INTERIOR & CONTROL ILLUMINATION

BLUE LED KNOBS GLOW RED WHEN TURNED ON.

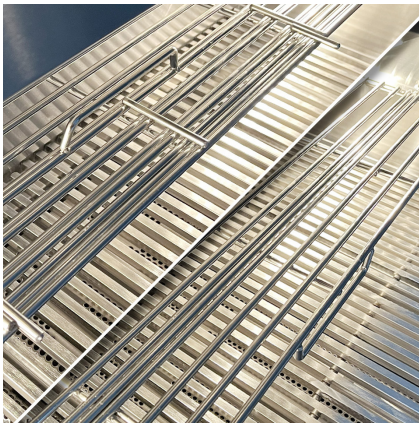

UPPER RACK EXTENDS

FROM 6" TO 9" PROVIDING 50% MORE SPACE FOR COOKING AND WARMING.



EASY LIFT HOOD

LIFT SPRING COUNTER BALANCED WELDED SS HOOD MOVES EFFORTLESSLY



FULL COVERAGE SS FLAME TAMERS

FORMED STAINLESS STEEL FLAME TAMERS ENABLE RAPID HEAT UP, GUARD THE BURNERS AND VAPORIZE DRIPPINGS TO ADD FLAVOR



BUILT-IN THERMOMETER

EASY TO READ TEMPERATURE GAUGE

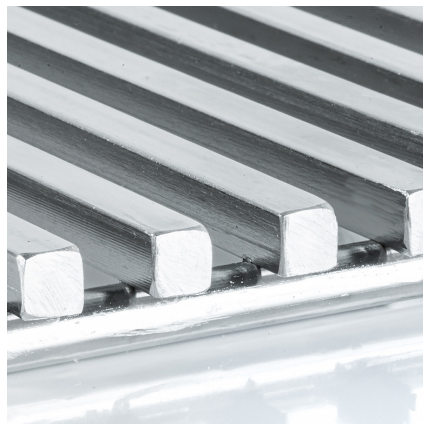

WELDED GRATES

HEAVY DUTY 304 STAINLESS GRATES HOLD HEAT FOR STRONG GRILL MARKS

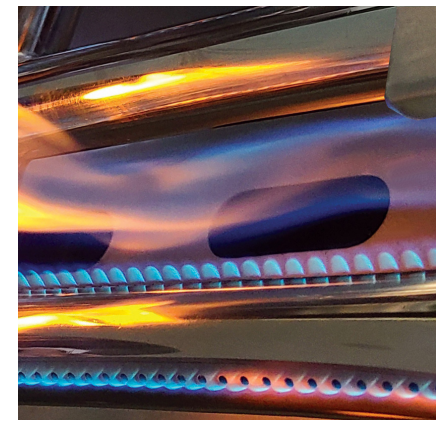

RELIABLE FLAME IGNITION

POSITIVE IGNITION WITHOUT AN ELECTRICAL CONNECTION