

Features

- Two lever handles allow for both volume and temperature control.
- 9" (229 mm) nondiverter spout.
- Coordinates with Devonshire faucets, accessories, and showering components to complete your bathroom.

Material

- Premium material construction for durability and reliability.
- KOHLER finishes resist corrosion and tarnishing.

Installation

- Bath- or deck-mount.

Required Products/Accessories

K-300-K High Flow Bath Valve

or

K-300-KR High Flow Valve w/ Rigid Connections

or

K-301-K ¾" High-Flow Bath Valve

Recommended Products/Accessories

K-23723 Faucet cleaner

Optional Products/Accessories

1032704 Deep Rough-In Kit

1032705 Deep Rough-In Kit



ADA **CSA B651** **OBC**

Codes/Standards

ASME A112.18.1/CSA B125.1

ADA

ICC/ANSI A117.1

CSA B651







OBC

KOHLER® Faucet Lifetime Limited Warranty

See website for detailed warranty information.

Available Colors/Finishes

Color tiles intended for reference only.

| Color | Code | Description |
|-------------------------------------------------------------------------------------|------|------------------------------------------------------|
|  | CP | Polished Chrome |
|  | PB | Vibrant® Polished Brass |
|  | BN | Vibrant® Brushed Nickel |
|  | BV | Vibrant® Brushed Bronze |
|  | BRZ | Oil-Rubbed Bronze |
|  | 2BZ | Oil-Rubbed Bronze |
|  | CB | Polished Chrome with Vibrant® Polished Brass Accents |

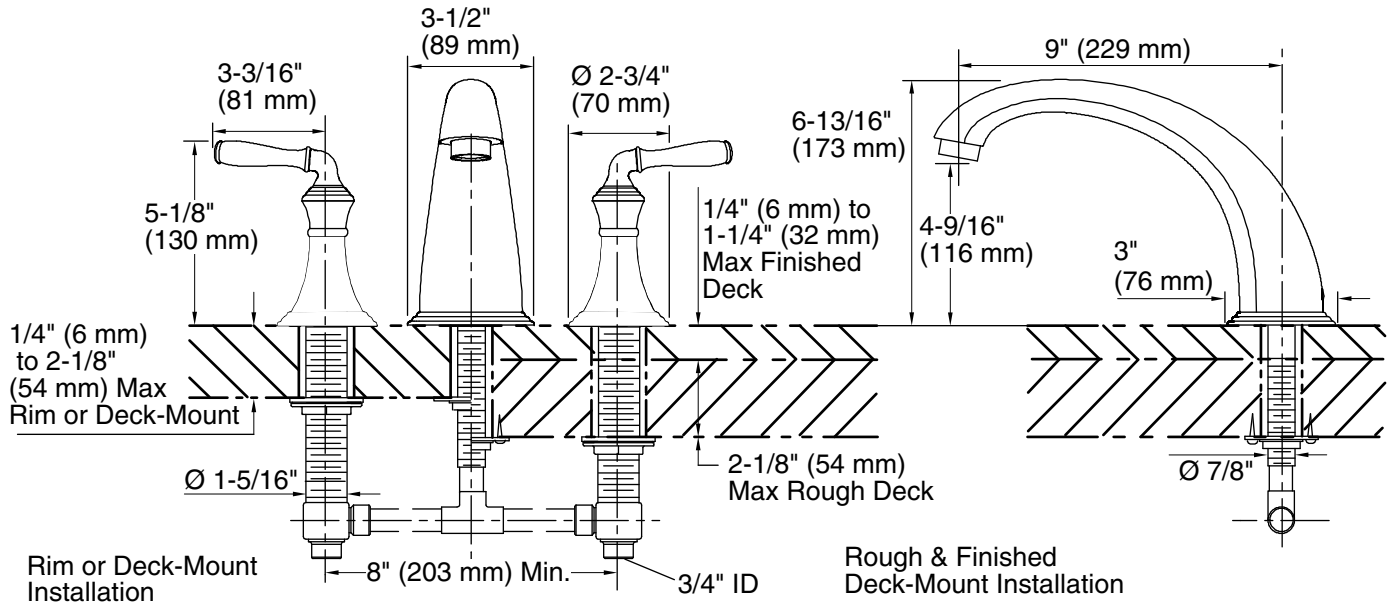

Technical Information

All product dimensions are nominal.

Drain included: No

Spout:

Spout reach: 9" (229 mm)

Notes

Install this product according to the installation guide.

ADA, OBC, CSA B651 compliant when installed to the specific requirements of these regulations.