



Elite

















Brugsvejledning















Sikkerhedsanvisninger

-  Inden maskinen tages i brug for første gang, skal denne vejledning læses grundigt. Gem vejledningen til senere brug.
- 

ADVARSLER !

-  Undlad at bruge maskinen uden korrekt montering af støvpose og filtre.
-  Denne maskine er ikke beregnet til opugning af farlige materialer eller gasser, da dette kan være meget sundhedsskadeligt.
-  Undlad at bruge maskinen til opugning af vand eller andre væsker.
-  Undlad at opsuge skarpe genstande såsom nåle og glasstykker.
-  Undlad at bruge maskinen til opugning af brændende eller rygende genstande som f.eks. cigaretter, tændstikker eller varm aske.
-  Brug og opbevar maskinen inden døre og i et tørt rum ved temperaturer på 0-60° C.
-  Maskinen må ikke bruges udendørs.
-  Når det automatiske ledningsoprul aktiveres, skal du være opmærksom på, at stikenden af ledningen kan svinge under den sidste del af indrulningen. Det anbefales at holde i stikket, mens ledningen rulles ind.
-  Tag ikke fat i maskinen med våde hænder.
-  Sluk for maskinen, før stikket tages ud.
-  Stikket trækkes ud ved at gribe fat om stikket og ikke ved at trække i ledningen. Undlad at bære eller trække i maskinen ved hjælp af ledningen.
-  Undlad at bruge maskinen, hvis ledningen viser tegn på skade. Kontrollér jævnligt ledningen for skader, især hvis den er blevet trykket, klemt i en dør eller kørt over.
-  Undlad at bruge maskinen udendørs, hvis den ser ud til at være defekt. Send maskinen til service på et autoriseret serviceværksted, hvis den er blevet tabt, beskadiget, efterladt udendørs eller har været udsat for vand.
-  Undlad at foretage ændringer af de mekaniske eller elektriske sikkerhedsanordninger.
-  Alle reparationer skal udføres af et autoriseret serviceværksted.
-  Brug kun originale støvposer, filtre og tilbehørsdele fra din lokale forhandler. Hvis der bruges ikke-originale støvposer og filtre, bortfalder garantien.
-  Sluk for maskinen, og tag stikket ud, før støvpose eller filter udskiftes. Husk at tage fat om stikket og ikke trække i ledningen.

-  Hvis ledningen er defekt, skal den udskiftes af producenten, dennes servicerepræsentant eller tilsvarende kvalificerede personer, så der ikke opstår farlige situationer.
-  Rør ikke ved maskinens roterende dele med hånden, når der anvendes turbomundstykke.
-  Denne maskine kan bruges af børn fra 8 år og opefter og af personer med nedsatte fysiske, sensoriske eller mentale funktioner, eller som mangler erfaring og kundskab, hvis de er under opsyn eller har fået vejledning i, hvordan apparatet benyttes på en forsvarlig måde, og forstår de farer, det indebærer.
-  Rengøring og vedligeholdelse må ikke udføres af børn, uden at de er under opsyn.
-  Børn skal være under opsyn for at sikre, at de ikke leger med maskinen.
-  Foretag ikke opladning af ikke-opladelige batterier.
-  Fjern genopladelige batterier fra maskinen, inden de oplades.
-  Bland ikke forskellige slags batterier eller nye og gamle batterier.
-  Sørg for korrekt polaritet ved isætning af batterier.
-  Fjern brugte batterier fra maskinen og bortskaf dem sikkert.
-  Hvis apparatet skal opbevares i længere tid, fjernes batterierne.
-  Kortslut aldrig forsyningsklemmerne.

Service og vedligeholdelse

Maskinen skal opbevares indendørs i tørre omgivelser.

- Skift forfiltret for hver fjerde støvpose.
- Rengør maskinen udvendig med en tør klud eller en klud fugtet med lidt opvaskemiddel.
- Bestil originalt ekstraudstyr fra din lokale forhandler.
- Service – kontakt din lokale forhandler.

Ansvar

Nilfisk fralægger sig ethvert ansvar for skader, der måtte opstå som følge af ukorrekt brug eller ukorrekte ændringer af maskinen. Der henvises til vores websted på adressen www.nilfisk.com for yderligere anvisninger og oplysninger om brug af maskinen.

WEEE



Symbolet  angiver, at denne maskine ikke må bortskaffes sammen med almindeligt husholdningsaffald, men skal indsamles separat. Udtjente maskiner skal afleveres på en miljøstation til genbrug.

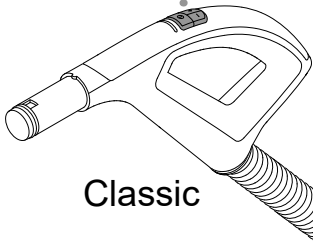
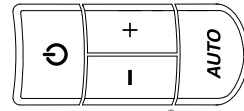
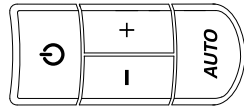
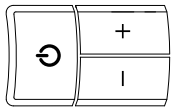

Classic

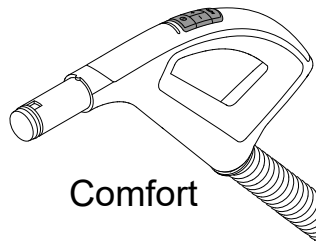

Comfort

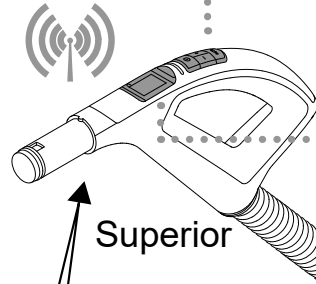

Superior

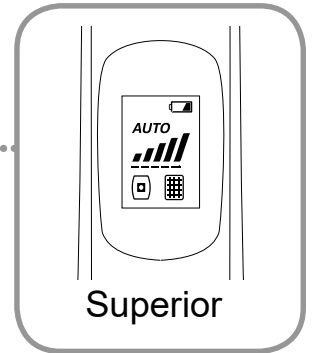

Superior

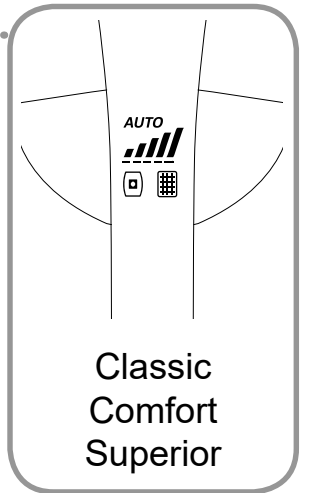

Classic
Comfort
Superior

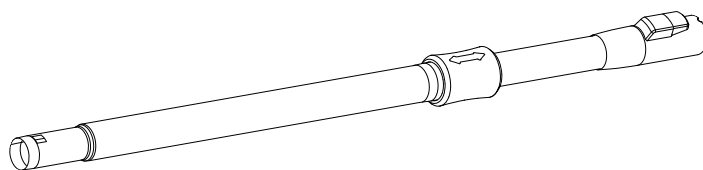
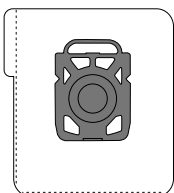
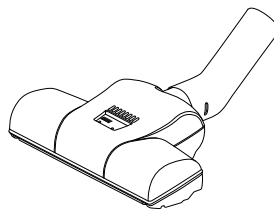
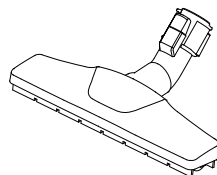
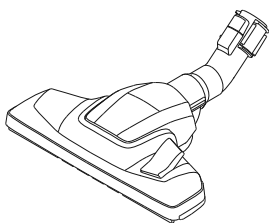
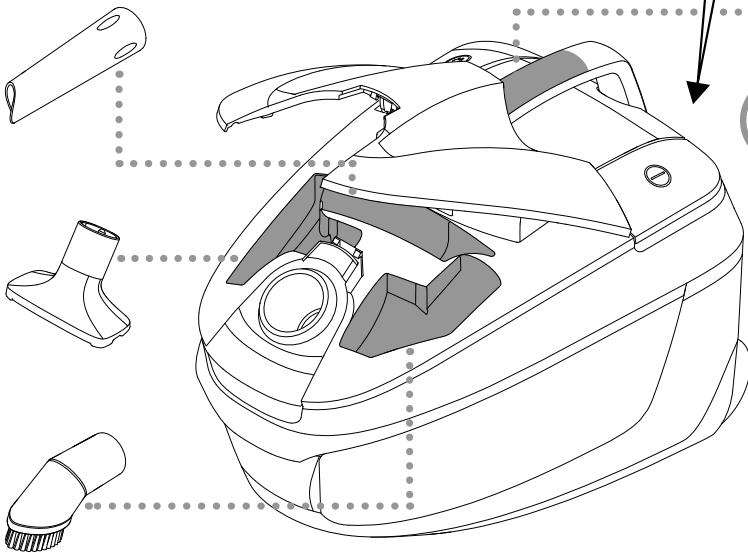

De medfølgende mundstykke typer afhænger af modellen.

A 

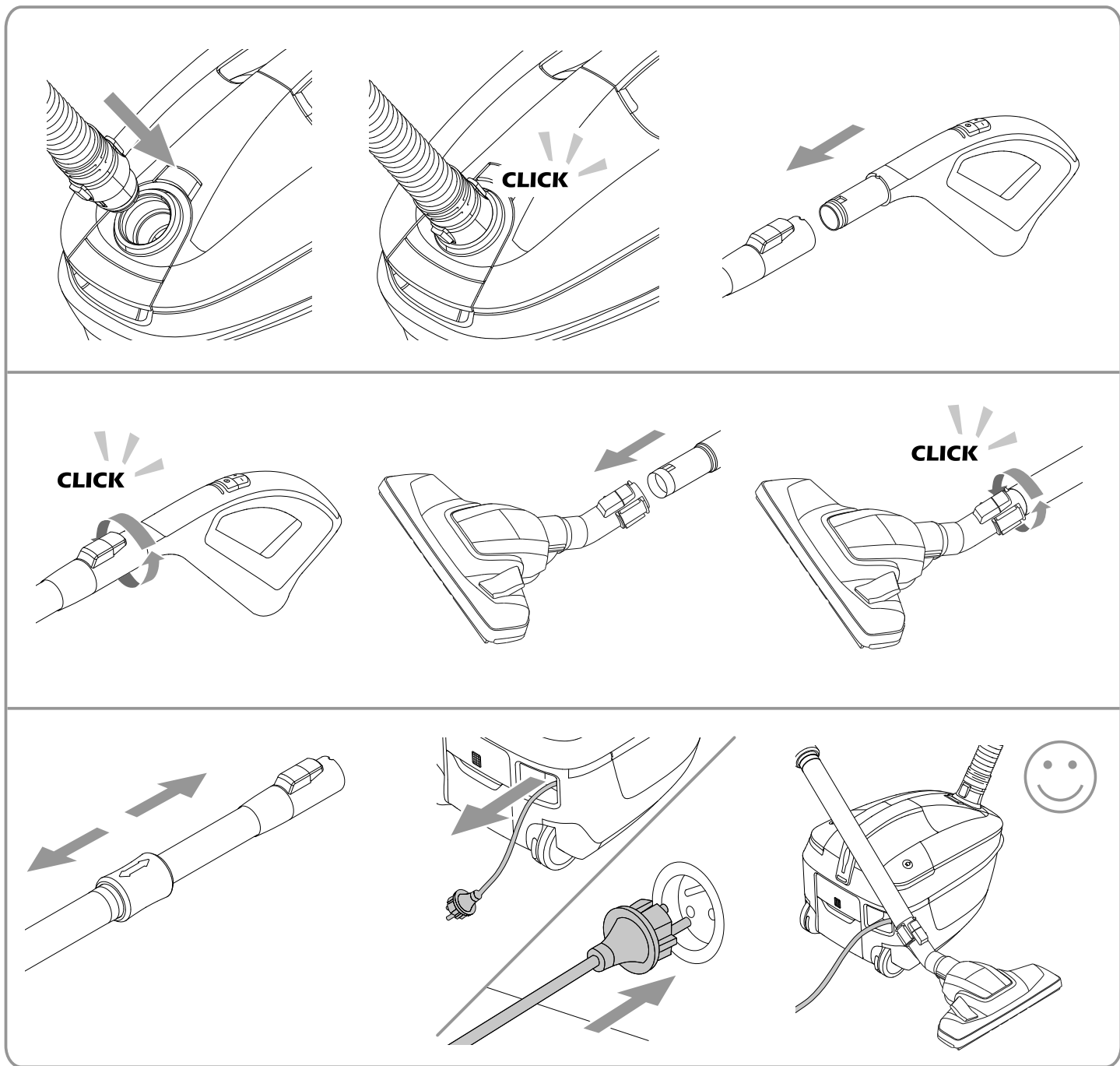

B 

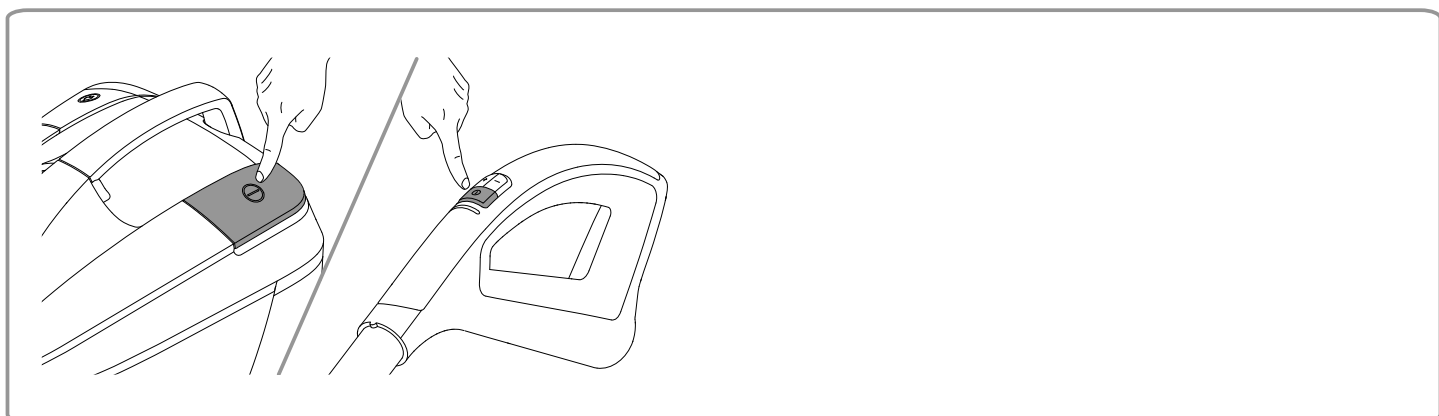

B 

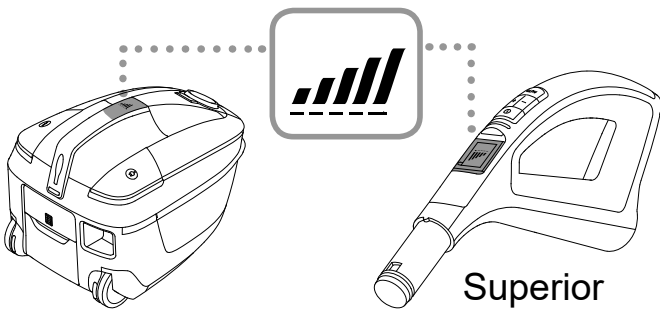
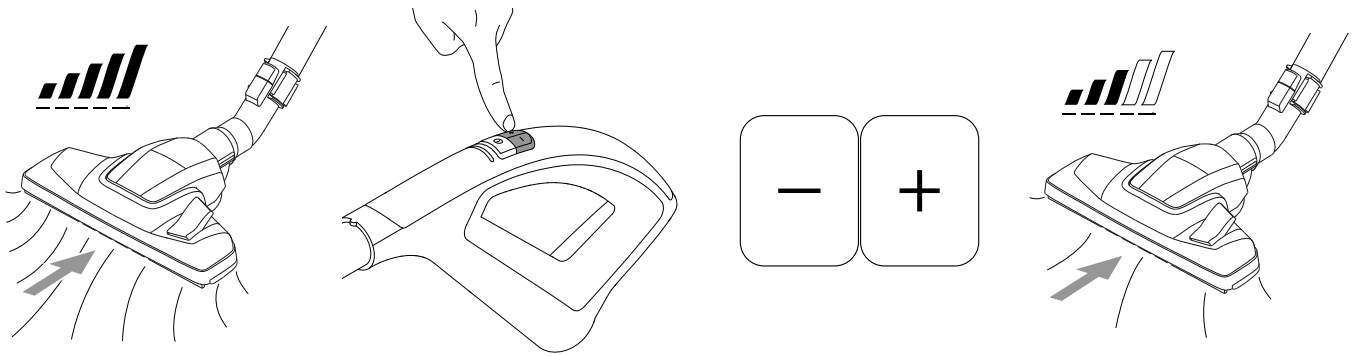

C 

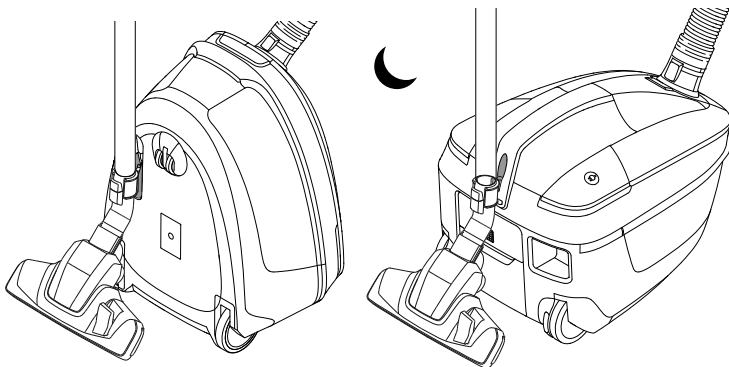

D 

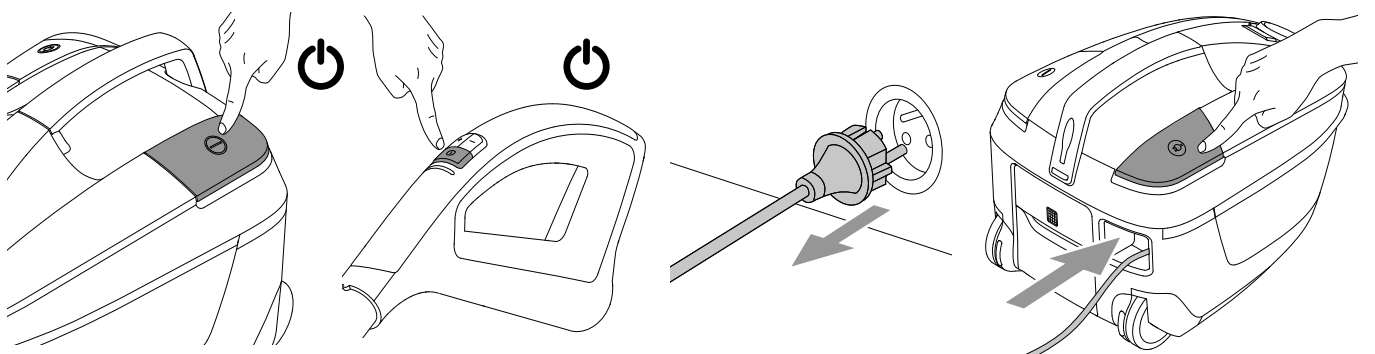

D

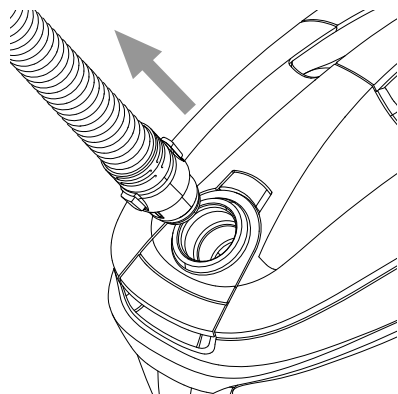
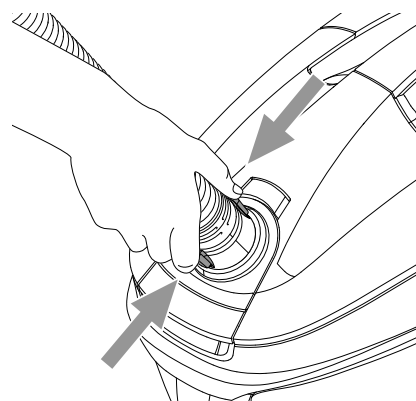
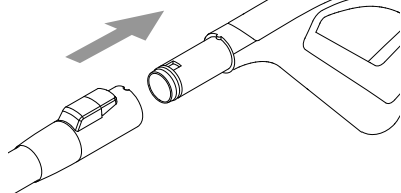
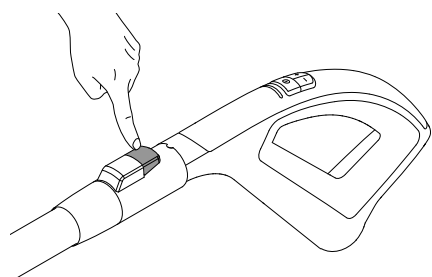
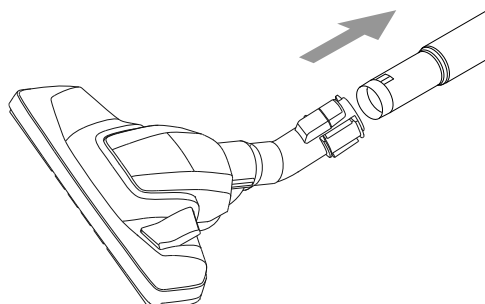
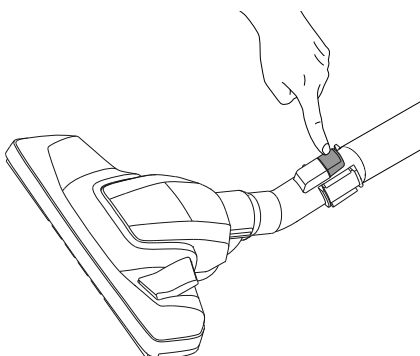
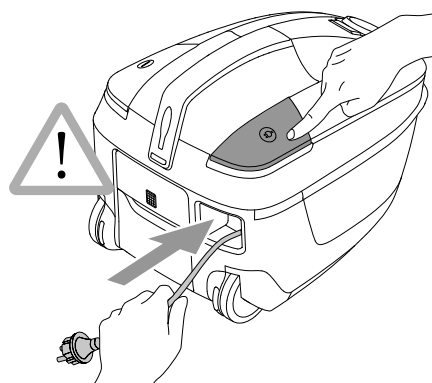

E

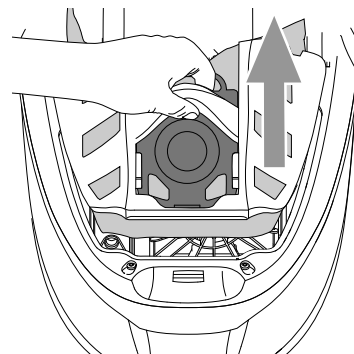
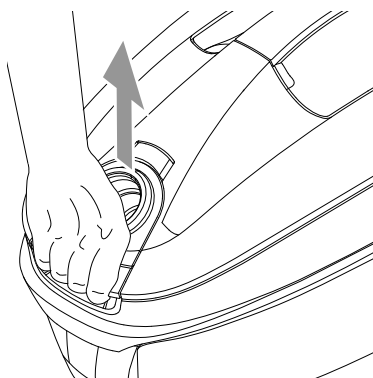
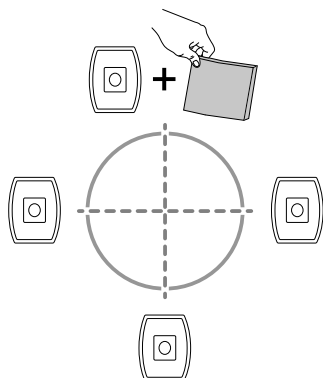

E 

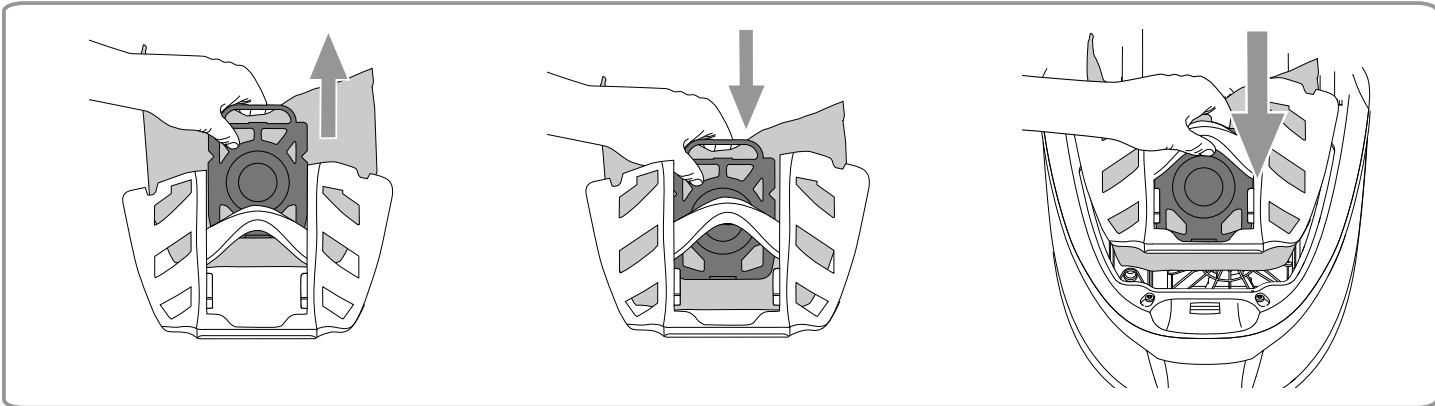

F 

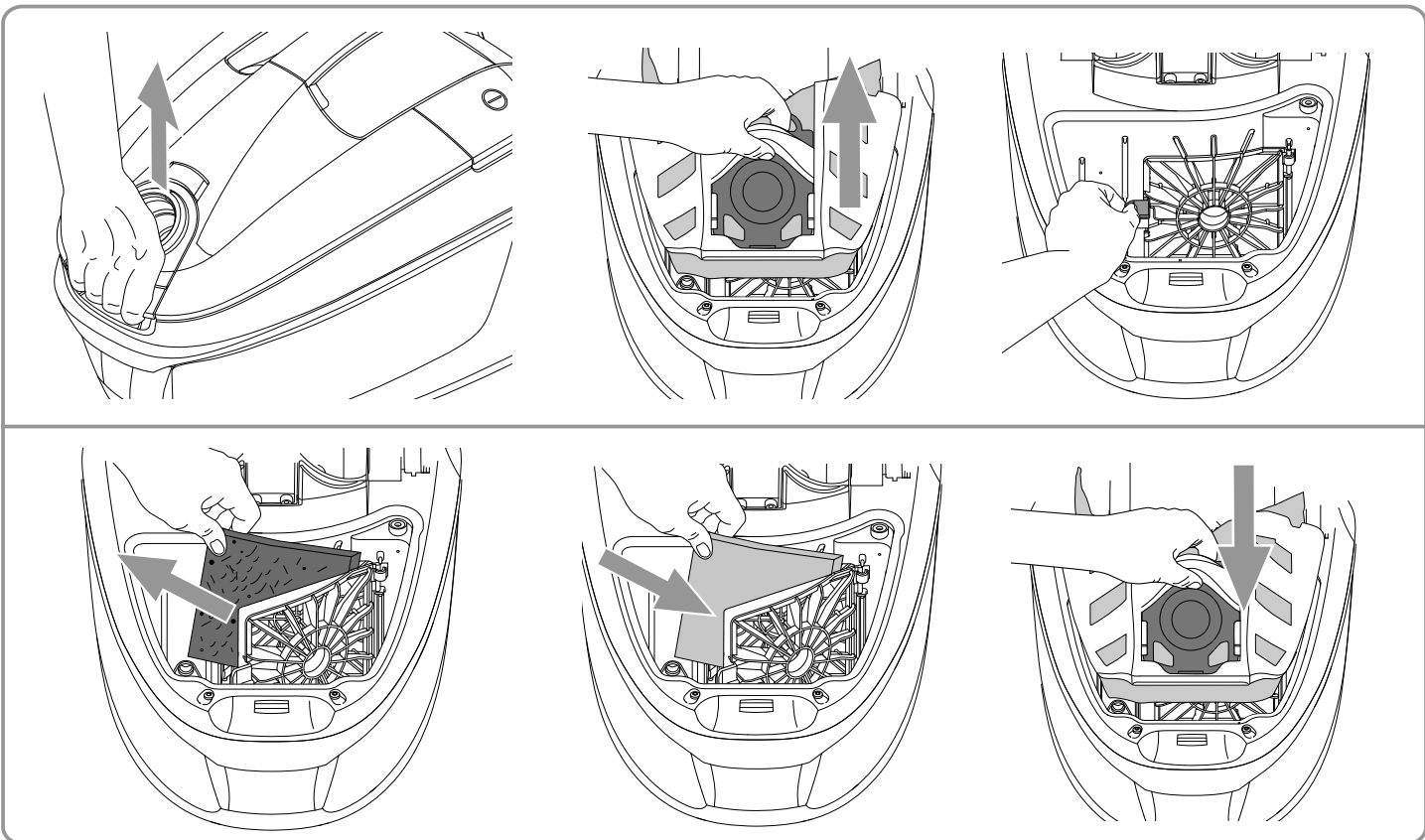

G 

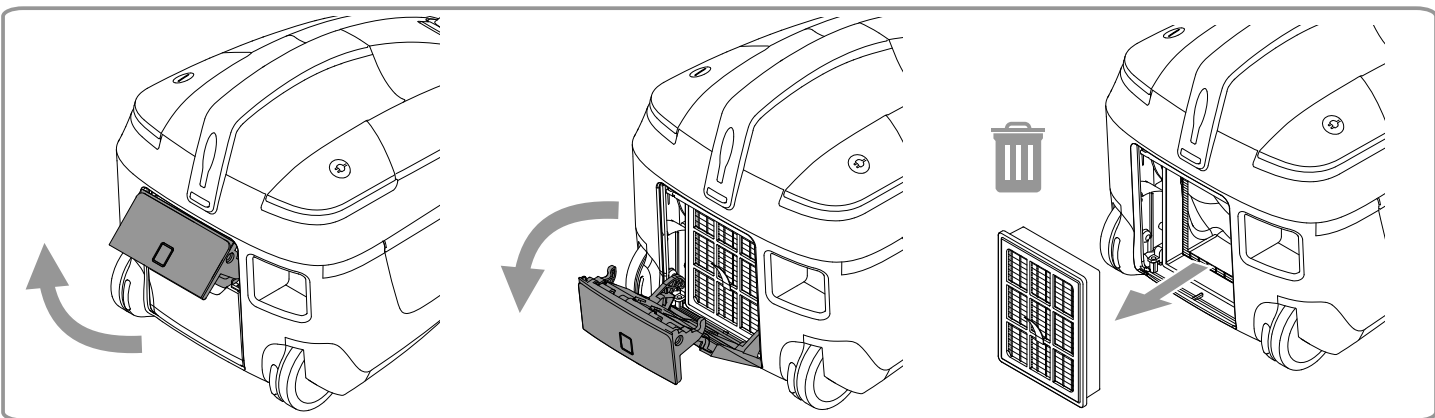

G

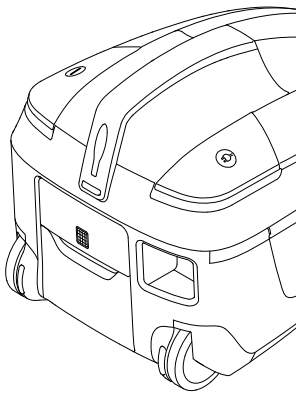
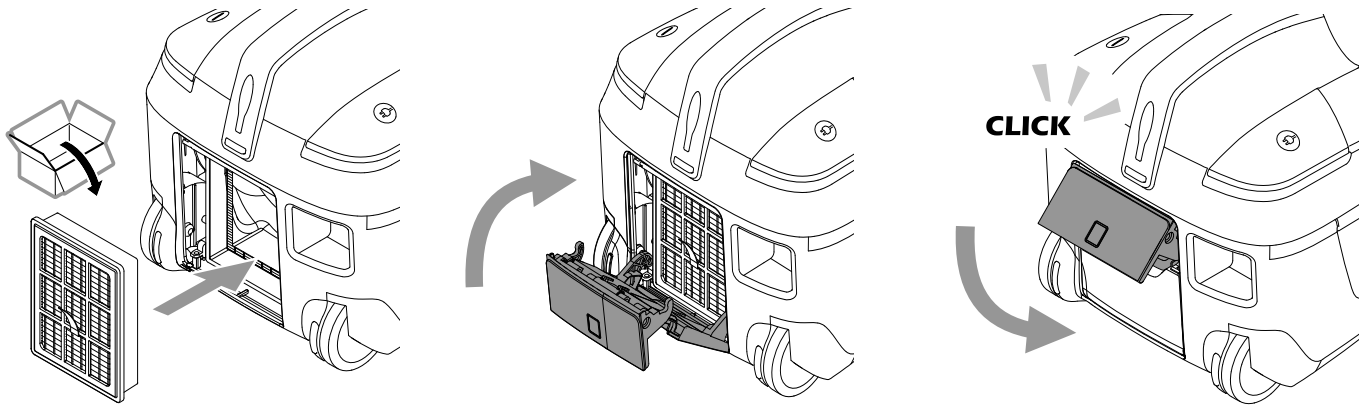

H

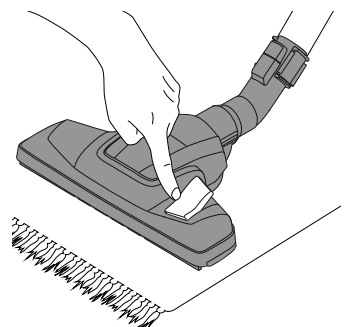
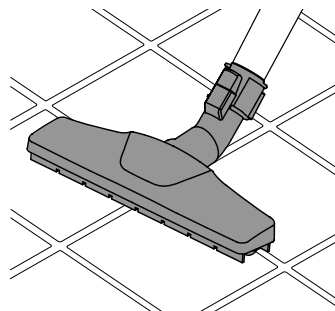
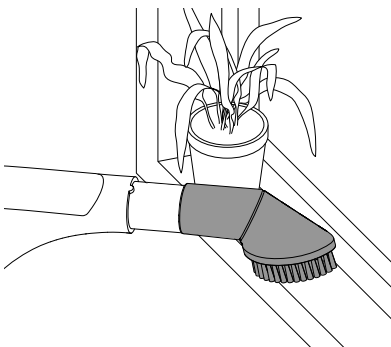
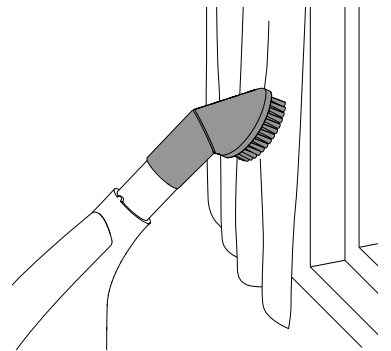
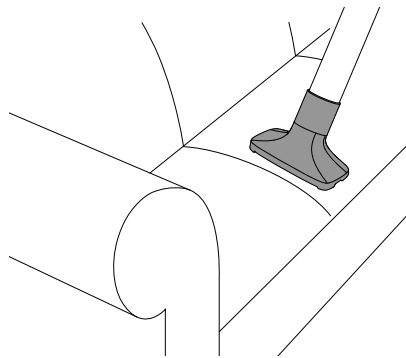
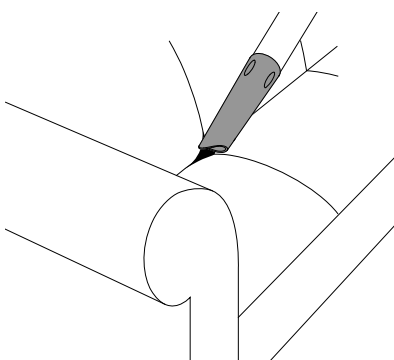

H

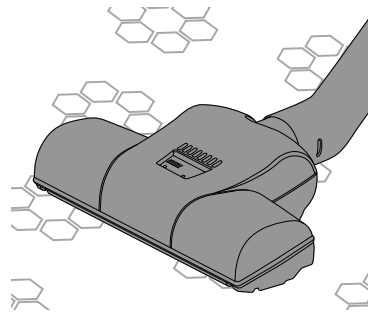
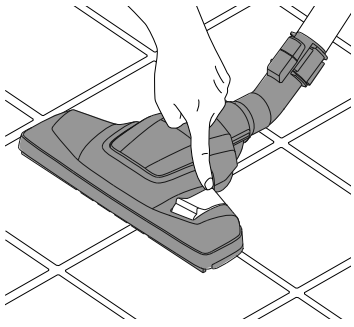

I

AUTO

Comfort,
Superior

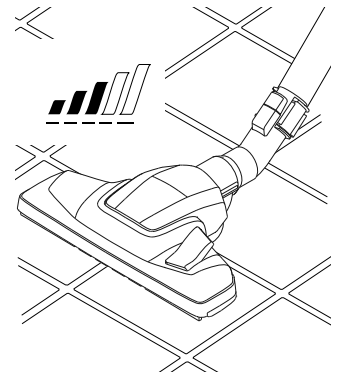
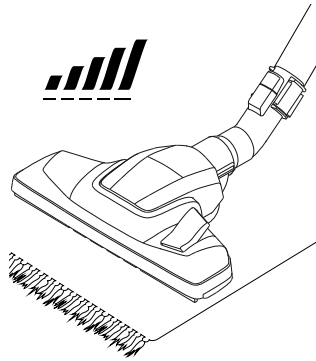
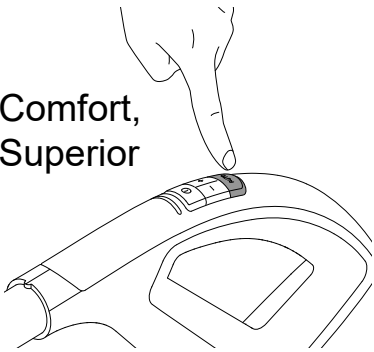

J

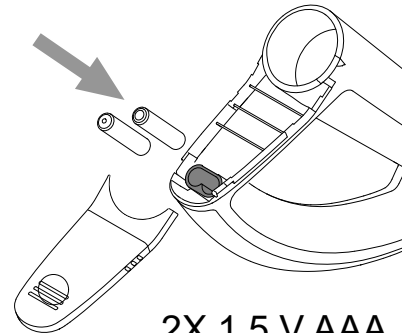
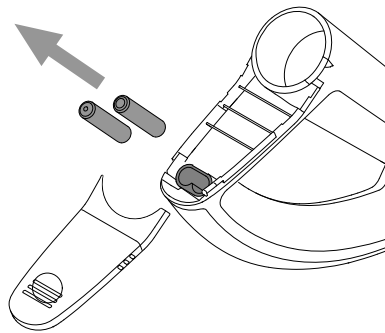
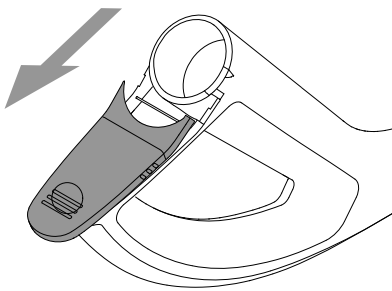

2X 1.5 V AAA

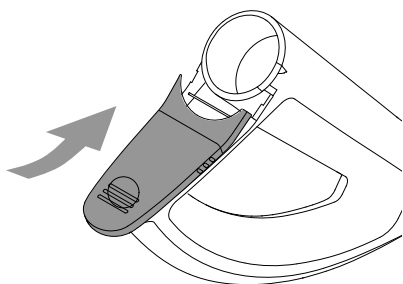

K

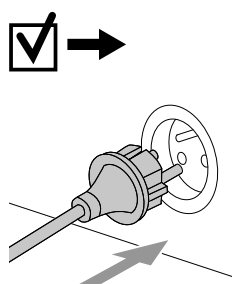
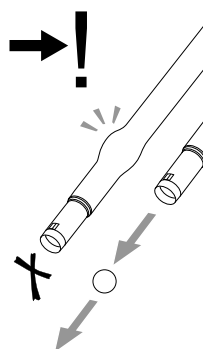
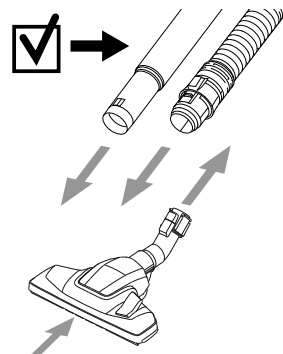
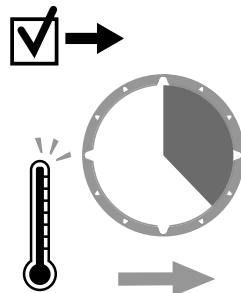
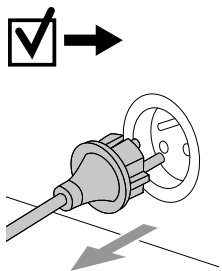
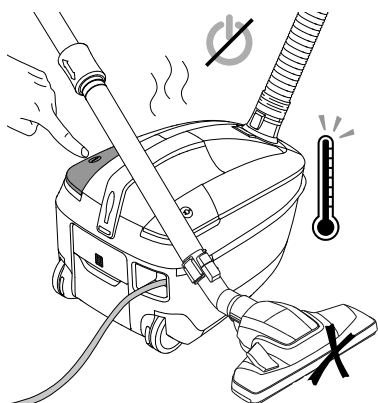

L

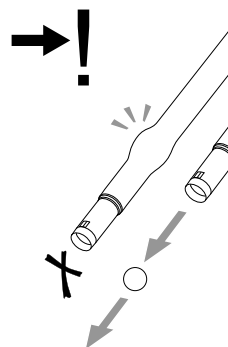
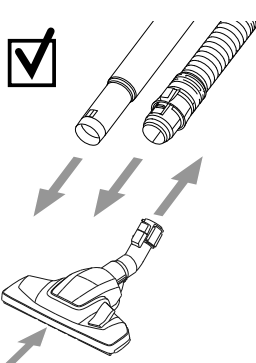
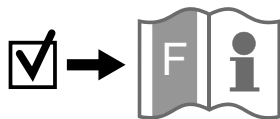
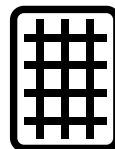
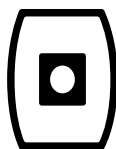
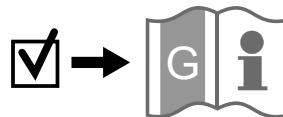
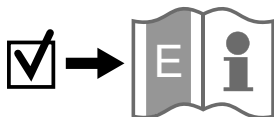
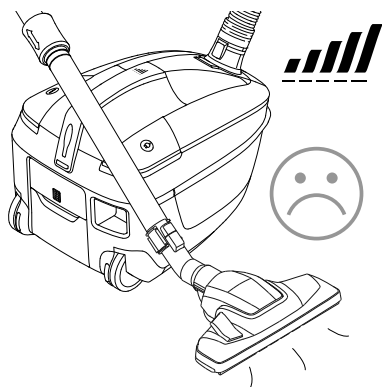

L

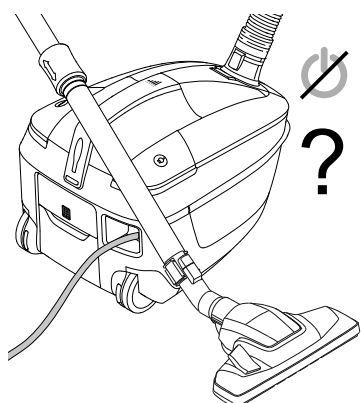

M

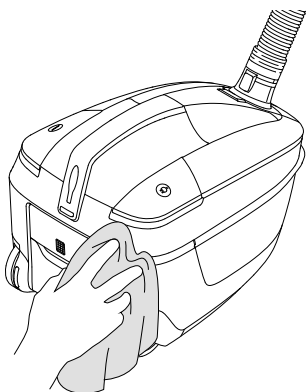
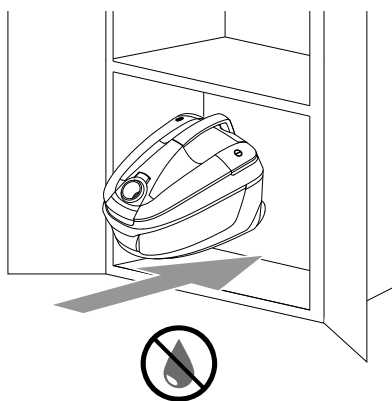



EU / UE / EL / EC / EE / ES / EÚ / AB

Declaration of Conformity

Prohlášení o shodě
Konformitätserklärung
Overensstemmelseserklæring
Declaración de conformidad
Vastavusdeklaratsioon
Déclaration de conformité
Vaatumustenmukaisuusvakuutus

Декларация за съответствие
Δήλωση συμμόρφωσης
Megfelelősségi nyilatkozat
Izjava o skladnosti
Dichiarazione di conformità
Atitikties deklaracija
Atbilstības deklarācija
Samsvarserklæring
Conformiteitsverklaring

Declaração de conformidade
Declaracja zgodności
Declaratie de conformitate
Декларация о соответствии
Försäkran om överensstämmelse
Vyhlásenie o zhode
Izjava o skladnosti
Uygunluk beyanı

Manufacturer / Výrobce / Hersteller / Fabrikant / Fabricante / Κατασκευαστής /
Gyártó / Proizvođač / Fabbicante / Gamintojas / Ražotājs / Produzent / Fabrikant /
Fabricante / Producent / Producător / производитель / Tillverkaren / Výrobca /
Proizvajalec / Üretici firma:

**Nilfisk A/S, Kornmarksvej 1
DK-2605 Broendby, DENMARK**

Product / Produkt / Producto, Toode, Produit, Tuote / Продукт /
Προϊόν / Termék / Proizvod / Prodotto / Produktas / Produkts /
Artikel / Produtos / Prods / Izdelek / Ürün

**Elite Performance Superior EU, Elite Performance
Comfort EU, Elite Performance Classic EU, Elite
Energy Classic EU**

Description / Popis / Beschreibung / Beskrivelse / Descripción /
Kirjeldus / La description / Kuvaus / Описание / Περιγραφή / Leirás /
Opis / Descrizione / Aprašymas / Apraksts / Beschrijving / Descrição /
Descriere / Beskrivning / Popis / Açıklama

**VAC - Consumer - Dry - Radio enabled
220-240V 50-60Hz, IPX0**

- EN** We, Nilfisk hereby declare under our sole responsibility, that the above-mentioned product(s) is/are in conformity with the following directives and standards.
- CS** My, Nilfisk prohlašujeme na svou výlučnou odpovědnost, že výše uvedený výrobek je ve shodě s následujícími směrnici a normami.
- DE** Wir, Nilfisk erklären in alleiniger Verantwortung, dass das oben genannte Produkt den folgenden Richtlinien und Normen entspricht.
- DA** Vi, Nilfisk erklærer hermed under eget ansvar at ovennævnte produkt(er) er i overensstemmelse med følgende direktiver og standarder.
- ES** Nosotros, Nilfisk declaramos bajo nuestra única responsabilidad que el producto antes mencionado está en conformidad con las siguientes directivas y normas
- ET** Meie, Nilfisk Käesolevaga kinnitame ja kanname ainuiskulist vastutust, et eespool nimetatud toode on kooskõlas järgmiste direktiivide ja
- FR** Nilfisk déclare sous notre seule responsabilité que le produit mentionné ci-dessus est conforme aux directives et normes suivantes.
- FI** Me, Nilfisk täten vakuutamme omalla vastuulla, että edellä mainittu tuote on yhdenmukainen seuraavien direktiivien ja standardien mukaisesti
- BG** Ние, Nilfisk с настоящото декларираме на своя лична отговорност, че посочените по-горе продуктът е в съответствие със следните директиви и стандарти.
- EL** Εμείς, Nilfisk δηλώνουμε με αποκλειστική μας ευθύνη, ότι το προαναφερόμενο προϊόν συμμορφώνεται με τις ακόλουθες οδηγίες και πρότυπα.
- HU** Mi, Nilfisk kijelentjük, egyedüli felelősséggel, hogy a fent említett termék megfelel az alábbi irányelveknek és szabványoknak
- HR** Mi, Nilfisk izjavljemo pod punom odgovornošću, da gore navedeni proizvod u skladu sa sljedećim direktivama i standardima.
- IT** Noi, Nilfisk dichiara sotto la propria responsabilità, che il prodotto di cui sopra è conforme alle seguenti direttive e norme.
- LT** Mes, "Nilfisk pareiškiu vienašališkos atsakomybės, kad pirmiau minėtas produkto atitinka šias direktyvas ir standartus
- LV** Mēs, Nilfisk šo apliecinu ar pilnu atbildību, ka iepriekš minētais produkts atbilst šādām direktīvām un standartiem
- NO** Vi, Nilfisk erklærer herved under eget ansvar, at det ovennevnte produktet er i samsvar med følgende direktiver og standarder
- NL** We verklaren Nilfisk hierbij op eigen verantwoordelijkheid, dat het bovengenoemde product voldoet aan de volgende richtlijnen en normen
- PT** Nós, a Nilfisk declaramos, sob nossa exclusiva responsabilidade, que o produto acima mencionado está em conformidade com as diretrizes e normas a seguir.
- PL** My, Nilfisk Niniejszym oświadczamy z pełną odpowiedzialnością, że wyżej wymieniony produkt jest zgodny z następującymi dyrektywami i normami.
- RO** Noi, Nilfisk Prin prezenta declarăm pe propria răspundere, că produsul mai sus menționat este în conformitate cu următoarele standarde și directive.
- RU** Мы, Nilfisk настоящим заявляем под нашу полную ответственность, что вышеперечисленные продукция соответствует следующими директивам и стандартам.
- SV** Vi Nilfisk förklarar härmed under eget ansvar att ovan nämnda produkt överensstämmer med följande direktiv och normer.
- SK** My, Nilfisk prehlasujeme na svoju výlučnú zodpovednosť, že vyššie uvedený výrobok je v zhode s nasledujúcimi smernicami a normami.
- SL** Mi, Nilfisk izjavljamo s polno odgovornostjo, da je zgoraj omenjeni izdelek v skladu z naslednjimi smernicami in standardi.
- TR** Nilfisk, burada yer alan tüm sorumluluklarımızı göze, yukarıda belirtilen ürünün aşağıdaki direktifler ve standartlara uygun olduğunu beyan ederiz.

	EN 60335-1:2012+A11:2014+A13:2017+A1:2019+A2:2019+A14:2019 EN 60335-2-2:2010+A11:2012+A1:2013
	EN 55014-1:2017, EN 55014-2:2015 EN 61000-3-2:2019, EN 61000-3-3:2013+A1:2019 EN 301 489-1:V2.1.1, EN 301 489-3:V2.1.1
2011/65/EU	EN 63000:2018
2009/125/EC 666/2013/EU	EN 60312-1:2017 EN 60704-2-1:2015
2014/53/EU – Freq Band: 433MHz; TX Max 0 dBm	EN 300 220-2:V3.1.1 RX Cat 2

Authorized signatory: Pierre Mikaelsson, Executive Vice President, Global Products & Services, Nilfisk NLT

May 29, 2020



HEAD QUARTER

DENMARK

Nilfisk A/S
Kornmarksvej 1
DK-2605 Broendby
Tel.: (+45) 4323 8100
Website: www.nilfisk.com

SALES COMPANIES

ARGENTINA

Nilfisk srl.
Edificio Central Park
Herrera 1855, 6th floor/604
Ciudad de Buenos Aires
Tel.: (+54) 11 6091 1571
Website: www.consumer.nilfisk.com.ar

AUSTRALIA

Nilfisk Pty Ltd
Unit 1/13 Bessemer Street
Blacktown NSW 2148
Tel.: (+61) 2 98348100
Website: www.consumer.nilfisk.com.au

AUSTRIA

Nilfisk GmbH
Metzgerstrasse 68
5101 Bergheim bei Salzburg
Tel.: (+43) 662 456 400 90
Website: www.nilfisk.at

BELGIUM

Nilfisk n.v.s.a.
Riverside Business Park
Boulevard Internationaaleaan 55
Bâtiment C3/C4 Gebouw
Bruxelles 1070
Tel.: (+32) 24 67 60 50
Website: www.consumer.nilfisk.be

Brazil

Nilfisk do Brasil
Av. Eng. Luis Carlos Berrini, 550
40 Andar, Sala 03
SP - 04571-000 Sao Paulo
Tel.: (+11) 3959-0300 / 3945-4744
Website: www.nilfisk.com.br

CANADA

Nilfisk Canada Company
240 Superior Boulevard
Mississauga, Ontario L5T 2L2
Tel.: (+1) 800-668-8400
Website: www.nilfisk.ca

CHILE

Nilfisk S.A. (Comercial KCS Ltda)
Salar de Llamara 822
8320000 Santiago
Tel.: (+56) 2684 5000
Website: www.nilfisk.cl

CHINA

Nilfisk
4189 Yindu Road
Xinzhuan Industrial Park
201108 Shanghai
Tel.: (+86) 21 3323 2000
Website: www.nilfisk.cn

CZECH REPUBLIC

Nilfisk s.r.o.
VGP Park Horní Počernice
Do Čertous 1/2658
193 00 Praha 9
Tel.: (+420) 244 090 912
Website: www.consumer.nilfisk.cz

DENMARK

Nilfisk A/S
Kornmarksvej 1
2605 Broendby
Tel.: (+45) 4323 4050
Website: www.consumer.nilfisk.dk

FINLAND

Nilfisk Oy Ab
Koskelontie 23 E
02920 Espoo
Tel.: (+358) 207 890 600
Website: www.consumer.nilfisk.fi

FRANCE

Nilfisk SAS
26 Avenue de la Baltique
Villebon sur Yvette
91978 Courtaubouef Cedex
Tel.: (+33) 169 59 87 24
Website: www.consumer.nilfisk.fr

GERMANY

Nilfisk GmbH
Guido-Oberdorfer-Strasse 2-10
89287 Bellenberg
Tel.: (+49) (0)7306/72-444
Website: www.consumer.nilfisk.de

GREECE

Nilfisk A.E.
Αναπαύσεως 29
Κορωπί Τ.Κ. 194 00

Tel.: (30) 210 9119 600
Website: www.consumer.nilfisk.gr

HOLLAND

Nilfisk B.V.
Versterkerstraat 5
1322 AN Almere
Tel.: (+31) 036 5460760
Website: www.consumer.nilfisk.nl

HONG KONG

Nilfisk Ltd.
2001 HK Worsted Mills
Industrial Building
31-39, Wo Tong Tsui St.
Kwai Chung, N.T.
Tel.: (+852) 2427 5951
Website: www.nilfisk.com

HUNGARY

Nilfisk Kft.
II. Rákóczi Ferenc út 10
2310 Szigetszentmiklós-Lakihegy
Tel.: (+36) 24 475 550
Website: www.nilfisk.hu

INDIA

Nilfisk India Limited
Pramukh Plaza, 'B' Wing, 4th floor, Unit No. 403
Cardinal Gracious Road, Chakala
Andheri (East) Mumbai 400 099
Tel.: (+91) 22 6118 8188
Website: www.nilfisk.in

IRELAND

Nilfisk
1 Stokes Place
St. Stephen's Green
Dublin 2
Tel.: (+35) 3 12 94 38 38
Website: www.nilfisk.ie

ITALY

Nilfisk SpA
Strada Comunale della Braglia, 18
26862 Guardamiglio (LO)
Tel.: (+39) (0) 377 414021
Website: www.nilfisk.it

JAPAN

Nilfisk Inc.
1-6-6 Kita-shinyokohama, Kouhoku-ku
Yokohama, 223-0059
Tel.: (+81) 45548 2571
Website: www.nilfisk.com

MALAYSIA

Nilfisk Sdn Bhd
Sd 33, Jalan KIP 10
Taman Perindustrian KIP
Sri Damansara
52200 Kuala Lumpur
Tel.: +603 6275 3120
Website: www.nilfisk.com

MEXICO

Nilfisk de Mexico, S. de R.L. de C.V.
Pirneos #515 Int.
60-70 Microparque
Industrial WSantiago
76120 Queretaro
Tel.: (+52) (442) 427 77 00
Website: www.nilfisk.com

NEW ZEALAND

Nilfisk Limited
Suite F, Building E
42 Tawa Drive
0632 Albany Auckland
Tel.: (+64) 9 414 1996
Website: www.nilfisk.com

NORWAY

Nilfisk AS
Bjørnerudveien 24
1266 Oslo
Tel.: (+47) 22 75 17 80
Website: www.consumer.nilfisk.no

PERU

Nilfisk S.A.C.
Calle Boulevard 162, Of. 703, Lima 33- Peru
Lima
Tel.: (511) 435-6840
Website: www.nilfisk.com

POLAND

Nilfisk Sp. Z.O.O.
Millenium Logistic Park
ul. 3 Maja 8, Bud. B4
05-800 Pruszków
Tel.: (+48) 22 738 3750
Website: www.consumer.nilfisk.pl

PORTUGAL

Nilfisk Lda.
Sintra Business Park
Zona Industrial Da Abrunheira
Edifício 1, 1º A
P2710-089 Sintra
Tel.: (+351) 21 911 2670
Website: www.nilfisk.pt

RUSSIA

Nilfisk LLC

Vyatskaya str. 27, bld. 7/1st
127015 Moscow
Tel.: (+7) 495 783 9602
Website: www.consumer.nilfisk.ru

SINGAPORE

Den-Sin
22 Tuas Avenue 2
639453 Singapore
Tel.: (+65) 6268 1006
Website: www.densin.com

SLOVAKIA

Nilfisk s.r.o.
Bancikovej 1/A
SK-821 03 Bratislava
Tel.: (+421) 910 222 928
Website: www.consumer.nilfisk.sk

SOUTH AFRICA

Nilfisk (Pty) Ltd
Kimbul Office Park, 9 Zeiss Road
Laser Park, Honeydew
Johannesburg
Tel.: (+27) 118014600
Website: www.nilfisk.co.za

SOUTH KOREA

Nilfisk Korea
3F Duksoo B/D. 317-15
Sungsoo-Dong 2Ga
Sungdong-Gu, Seoul
Tel.: (+82) 2497 8636
Website: www.nilfisk.co.kr

SPAIN

Nilfisk S.A.U
Paseo del Rengle, 5 Planta. 9-10
08302 Mataró
Tel.: (+34) 93 741 2400
Website: www.consumer.nilfisk.es

SWEDEN

Nilfisk AB
Taljegårdsgatan 4
431 53 Mölndal
Tel.: (+46) 31 706 73 00
Website: www.consumer.nilfisk.se

SWITZERLAND

Nilfisk AG
Ringstrasse 19
Kircheberg/Industri Stelz
9500 Wil
Tel.: (+41) 71 92 38 444
Website: www.consumer.nilfisk.ch

TAIWAN

Nilfisk Ltd
Taiwan Branch (H.K)
No. 5, Wan Fang Road
Taipei
Tel.: (+88) 6227 00 22 68
Website: www.nilfisk.tw

THAILAND

Nilfisk Co. Ltd.
89 Soi Chokechai-Ruammitr
Viphavadee-Rangsit Road
Ladyao, Jatuchak, Bangkok 10900
Tel.: (+66) 2275 5630
Website: www.nilfisk.co.th

TURKEY

Nilfisk A.S.
Serifali Mh. Bayraktar Bulv. Sehit Sk. No:7
Ümraniye, 34775 Istanbul
Tel.: +90 216 466 94 94
Website: www.consumer.nilfisk.com.tr

UNITED ARAB EMIRATES

Nilfisk Middle East Branch
SAIF-Zone
P.O. Box 122298
Sharjah
Tel.: (+971) (0) 655-78813
Website: www.nilfisk.com

UNITED KINGDOM

Nilfisk Ltd.
Nilfisk House, Bowerbank Way
Gilwilly Industrial Estate, Penrith
Cumbria CA11 9BQ
Tel.: (+44) (0) 1768 868995
Website: www.consumer.nilfisk.co.uk

UNITED STATES

Nilfisk Inc.
14600 21st Avenue North
Plymouth, MN-55447
Tel.: (+1) 800-989-2235
Website: www.nilfisk.com

VIETNAM

Nilfisk Vietnam
No. 51 Doc Ngu Str.
P. Vinh Phuc, Q.Ba Dinh
Hanoi
Tel.: (+84) 761 5642
Website: www.nilfisk.com

