

ASSEMBLY INSTRUCTION

X-FRAME 5-SHELF BOOKCASE

A Shelf

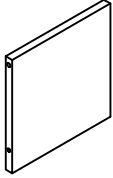

5pcs

B Bottom

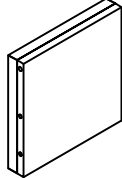

1pc

C Side Panel

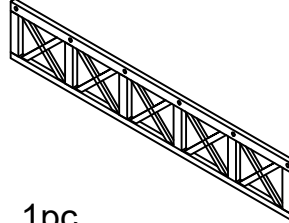

1pc

D Back Panel

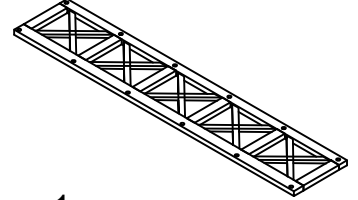

1pc

E Bolt
Ø1/4"x32mm



18pcs

F Lock Washer
Ø1/4"



18pcs

G Flat Washer
Ø1/4"x15x1.5mm



18pcs

H Allen Key
M4

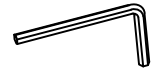

1pc

I Wood Dowel
Ø8x30mm



14pcs

J Anti-Tipping Kit

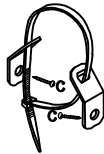

2sets

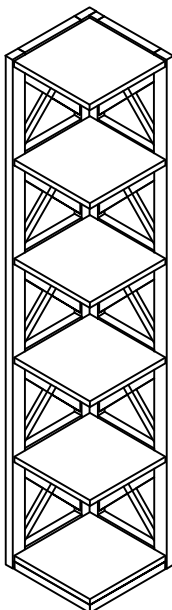

This page lists all the contents included in the box. Please take the time to identify the hardware as well as the individual components to this product. As you unpack and prepare for assembly, place the contents on a carpeted or padded area to protect them from damage.

-
- 3** Remark: There is a tip restraint kit provided on the back of this product.
Please refer carefully to the instruction on the tip restraint kit and following instruction picture for installation.

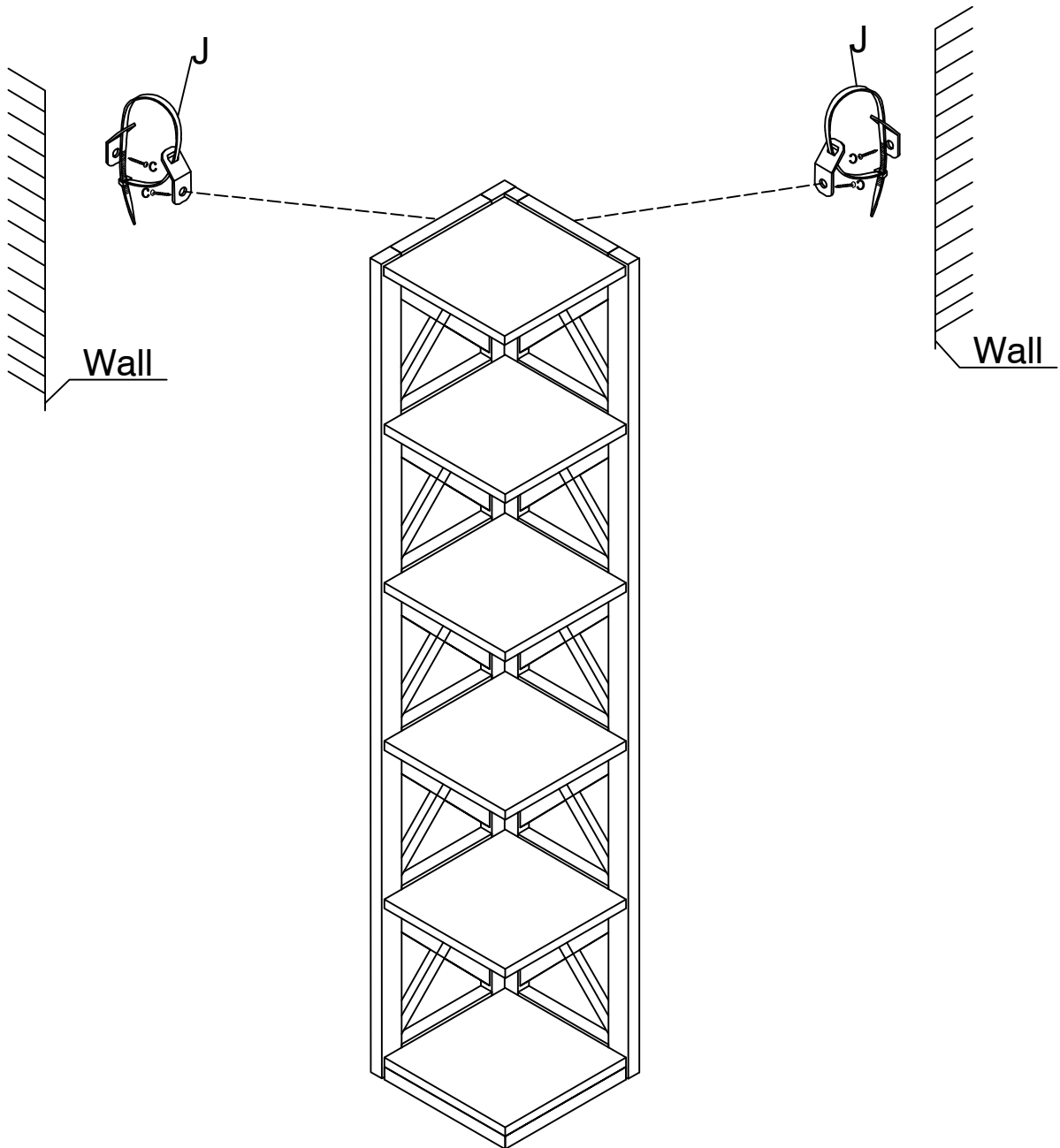

Cleaning & Care

Treat surface with care. Surface is resistant to scratches but is not scratch resistant. Clean surfaces with a dry or damp soft cloth. Do not use abrasive cleaners. Hardware may loosen over time. Periodically check that all connections are tight.