









# HEKMAN®

**X** A HOWARD MILLER COMPANY

## 79170P PEDS & MODESTY PANEL 79170T TOP PANEL

HARDWARE LIST				
A	B	C	D	E
ALLEN BOLT M <sup>5/16</sup> " X 45 (4 PCS.)	FLAT W. M8 (6 PCS.)	SPRING W. M8 (6 PCS.)	ALLEN BOLT M <sup>5/16</sup> " X 150 (2 PCS.)	ALLEN KEY L5 (FOR BOLT M <sup>5/16</sup> " 1 PC.)
				

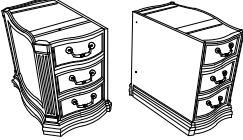

PART INSIDE		
1	2	3
TOP ASSEMBLY (1 Pc)	PEDESTALS (2 Pcs)	MODESTY PANEL (1 Pc)
		

### Assembly Instruction

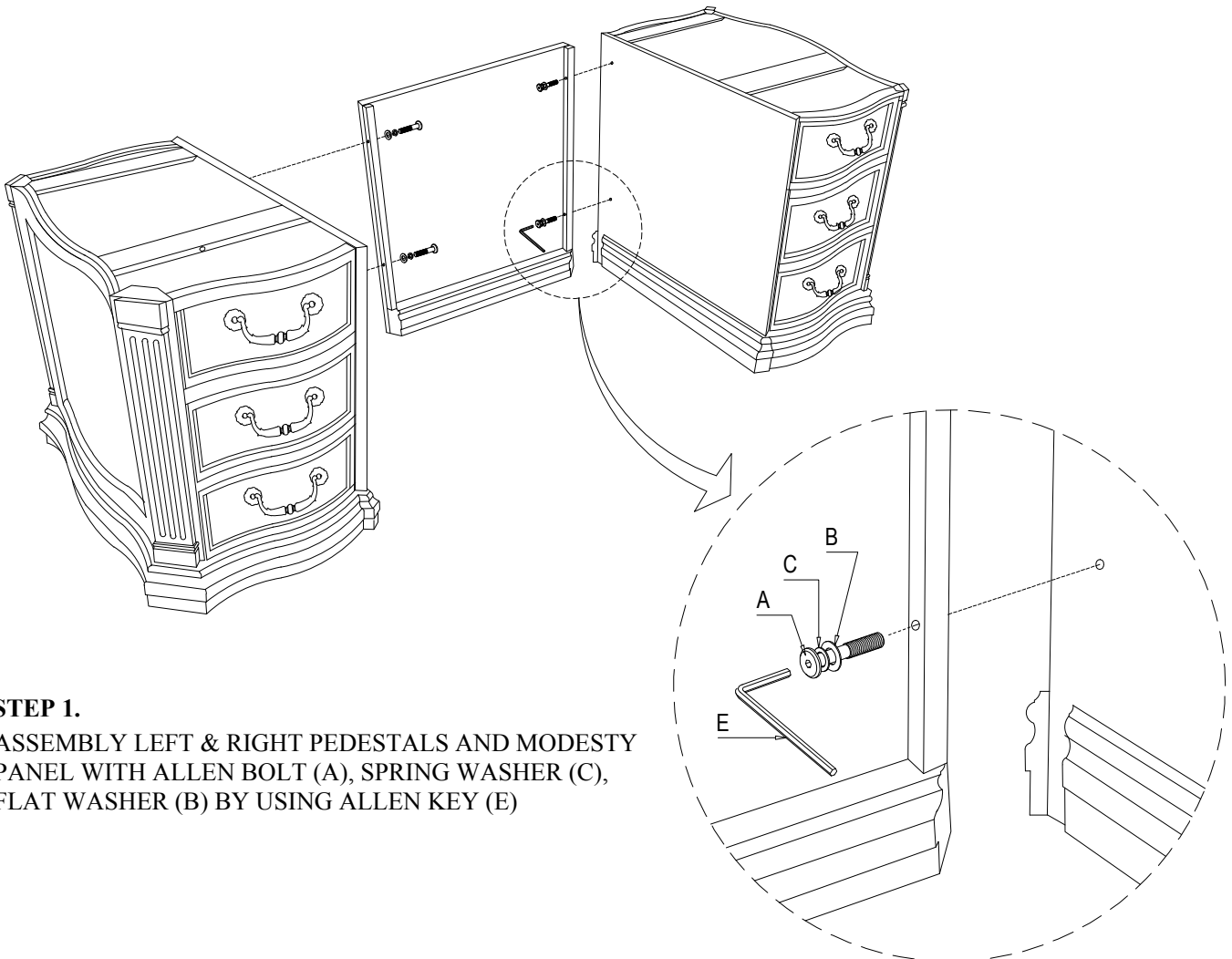

**STEP 1.**  
ASSEMBLY LEFT & RIGHT PEDESTALS AND MODESTY  
PANEL WITH ALLEN BOLT (A), SPRING WASHER (C),  
FLAT WASHER (B) BY USING ALLEN KEY (E)

**STEP 2.**

PLACE THE TOP ASSEMBLY ON THE PEDESTALS. AS SHOWN IN THE SIDE VIEW THE TOP ASSEMBLY IS SET A LITTLE FORWARD ON THE PEDESTALS THAN PUSHED BACK TO LOCK FRENCH CLEAT.  
OPEN THE UPPER DRAWERS IN THE PEDESTALS.  
SCREW THE TOP PANEL ASSEMBLY AND PEDESTALS WITH ALLEN BOLT (D), SPRING WASHER (C), FLAT WASHER (B) BY USING ALLEN KEY (E).  
CLOSE UPPER DRAWERS.

