

## INSTALLATION INSTRUCTIONS

### JEWELRY DRAWER

#### TOOLS REQUIRED:

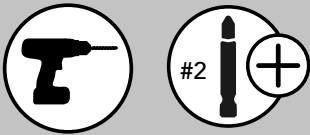

#### ESTIMATED ASSEMBLY TIME:

**10 MIN**

#### CARE AND MAINTENANCE:

Clean with a damp cloth and wipe parts dry.

#### STEP 1

Place the left and right brackets on the front of the drawer and screw into place using the supplied screws (See Fig. A).

#### STEP 2

Apply double sided tape to the front of the brackets (See Figure B).

#### STEP 3

Carefully line-up your desired drawer front position by eyesight, place the drawer front against the brackets. Apply pressure to adhere the drawer front to the brackets. Slowly pull drawer open and with the supplied screws attach the drawer front to the brackets (See Figure C).



Parts List		
No.	Description	Qty
A	Brackets	2
B	6 x 1/2" Screws	12
C	Double Sided Tape	4

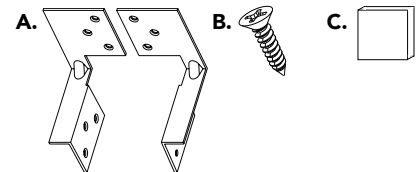

FIG. A

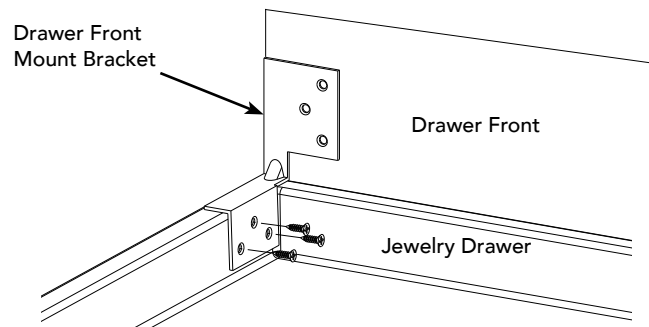

FIG. B

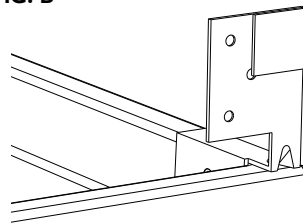
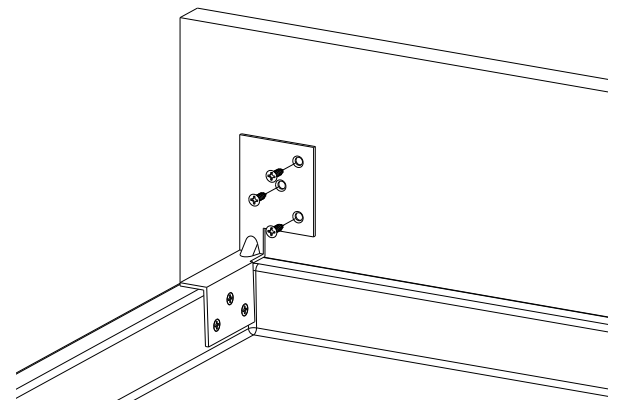

FIG. C



## INSTRUCCIONES DE INSTALACIÓN / INSTRUCTIONS D'INSTALLATION

### CAJÓN DE JOYERÍA / TIROIR À BIJOUX

#### TOOLS REQUIRED:

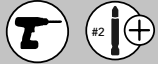

Tiempo estimado de ensamblado  
Durée de l'installation:

**10 MIN**

#### Cuidado/ Entretien:

Limpie con un paño húmedo y seque las partes.  
Nettoyer avec un chiffon humide et essuyer pour sécher complètement.

#### PASO 1 / ÉTAPE 1

Coloque los soportes izquierdo y derecho en la parte frontal del cajón y atorníllelos con los tornillos suministrados (Consulte Fig. A).

Placez les supports, gauche et droit, sur le devant du tiroir et vissez-les en place en utilisant les vis fournies (voir figure A).

#### PASO 2 / ÉTAPE 2

Aplique la cinta adhesiva de doble lado en la parte frontal de los soportes (Consulte Fig. B).

Appliquez le ruban double-face sur le devant des supports (Voir figure B).

#### PASO 3 / ÉTAPE 3

Alinee cuidadosamente la posición frontal del cajón deseada a la vista, coloque el frente del cajón contra los soportes. Aplique presión para adherir el frente del cajón hacia los soportes. Tire lentamente del cajón para abrirlo y, con los tornillos suministrados, fije la parte delantera del cajón a los soportes. (Consulte Fig. C).

Alignez soigneusement à l'œil la position voulue sur le devant du tiroir puis placez le devant du tiroir contre les supports. Appuyez pour que le devant du tiroir adhère aux supports. Tirez légèrement pour ouvrir le tiroir et à l'aide des vis fournies fixez le devant du tiroir aux supports (voir figure C).



#### Lista de partes / Liste des pièces

No.	Descripción / Description	Qty
A	Soportes / Supports	2
B	6 x tornillos de 1/2" 6 vis de 1/2 po	12
C	Cinta adhesiva de doble lado Ruban double-face	4

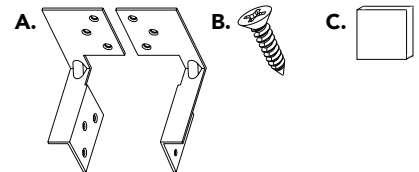

FIG. A

Soporte de montaje frontal del cajón  
Support de montage du devant du tiroir

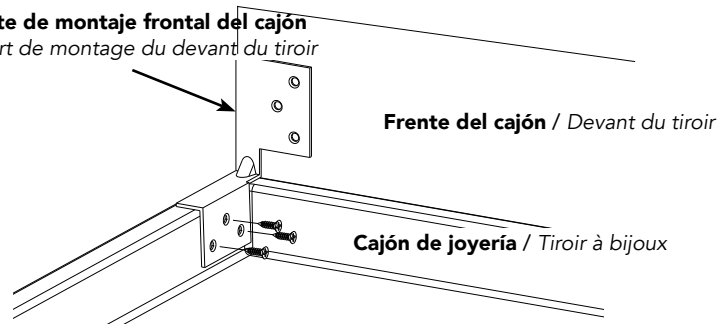

FIG. B

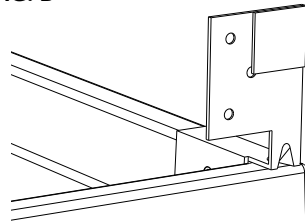

FIG. C

