



Variation not shown: 4" Trim Plate

**BASYS® Sensor Faucet**

**EFX-175-4-SOL-ISM-CP-1.5GPM-FCT**

**Product description**

4" Trim Plate, Solar Power Supply, Integrated Side Mixer, Polished Chrome Finish, 1.5 gpm, Aerated (installed) or Laminar (in box) Spray, Infrared Sensor, BASYS® Solar-Powered Deck-Mounted High Body Faucet.

**Compliances & Certifications**









(ADA Compliant, ASME A112.18.1 Compliant, CEC Compliant, EPD, HPD, IAPMO, Proposition 65, TAS, UPC Low Lead Certified, WELL Building Standard)

**Code 3324028**

**Finish**

-  Polished Chrome (CP)

**Downloads**

-  [EFX 1Xx\\_2Xx Installation Instructions.pdf](#)
-  [EFX 1Xx\\_2Xx \(SP\) Installation Instructions.pdf](#)
-  [IR FAQs Repair and Maintenance Guide.pdf](#)
-  [IR FAQs SP Repair and Maintenance Guide.pdf](#)
-  [Faucet and Soap Dispenser Brochure.pdf](#)
-  [Faucets Brochure \(Spanish\).pdf](#)
-  [Additional Downloads](#)

**Videos**

-  [Sloan Connect App®](#)
-  [BASYS® Faucet Installation and Features](#)

# Product Information

## Details

- Flow Rate: 1.5 gpm (5.7 Lpm) (1.5GPM)
- Spray Type: Aerated (installed) or Laminar (in box)
- Sensor Type: Infrared
- Mounting Type: Single Hole
- Trim Plate: 4" (102 mm) (4)
- Power Supply: Solar (SOL)
- Temperature Mixer: Integrated Side Mixer (ISM)
- Finish: Polished Chrome (CP)
- Factory Default Timeout: 10s
- Factory Default GPC: 0.75 gpc

## Features

Commercial Grade, ADA Compliant, Electronic, Sensor-Activated, Die-Cast Metal Hand Washing Faucet with the following features:

- One tool service
- All wetted components to be stainless steel, engineered thermoplastic, EPDM, and copper or copper alloy
- Solenoid housed in removable carrier that includes supply strainer
- Integral water supply shut off
- Supply strainer serviceable from above deck
- Vandal resistant spray insert, key housed inside faucet body
- All electronics sealed to IP-67
- Gold plated electrical contacts
- Above deck individual diagnostic indicators for battery life, solenoid condition, and power-up mode
- Flexible, high pressure supply hoses, 3/8" compression connections
- Bi-stable magnetic solenoid
- Four (4) "AA" alkaline batteries
- Double infrared sensors with automatic setting feature
- Single hole installation
- Includes all mounting hardware
- Line purge mode, eliminates stagnant water
- Adjustable time-outs
- 3 year limited warranty
- Chrome plated finish

# EFX-175-4-SOL-ISM-CP-1.5GPM-FCT

## Recommended specifications

Sloan BASYS Model No. EFX-175-4-SOL-ISM-CP-1.5GPM-AER-IR-FCT Infrared Sensor Activated Electronic Handwashing Faucet for pretempered or hot/cold water supplies. Product to have double infrared sensors with automatic setting feature. Solenoid valve housed in removable carrier that closes water supply upon removal eliminating, need to access control stops. Solenoid carrier includes strainer for easy above deck service. Thermostatic mixer ordered separately to comply with ASSE 1070 requirements. The product shall be tested and certified to industry standards: ASME A112.18.1M, CSA B125.1, California Health and Safety Code 116875

## Electrical specifications

- Battery Life: 3 years 8,000 cycles/month
- Optional power harvesting significantly extends service life
- Sensor Range: 4" -5" (102-127 mm)

## Warranty

[View Warranty Information](#)

## Notes

All information contained within this document subject to change without notice.

Looking for other variations of the EFX-175 product? [View the general spec sheet with all options.](#)

[Find a matching soap dispenser](#) for this faucet.

[Find a compatible sink](#) for this faucet

**EFX-175.00X.0X0X Faucet**  
with Single Line Water Supply

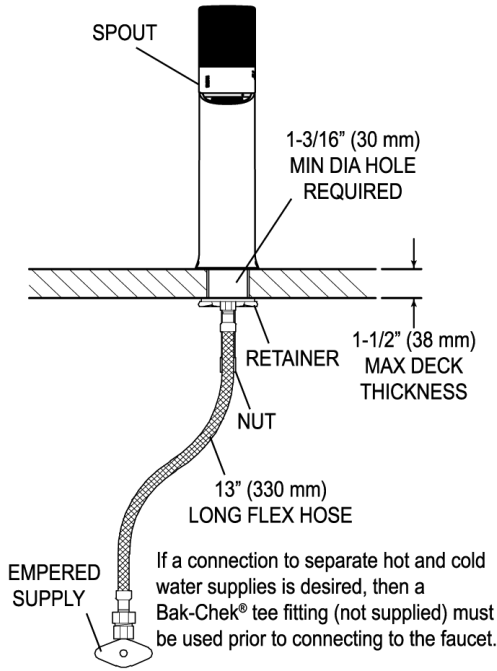

**EFX-175.50X.0X0X Faucet**  
with Hot & Cold Water Supply

