



Sofa, 1 seat

Canapé 1 place / Sofa de 1 plaza



ITEM: 13056-13058
ARTICLE / ARTICULO

ASSEMBLY INSTRUCTIONS
INSTRUCTIONS D'ASSEMBLAGE / INSTRUCTIVO DE ARMADO

Ready to assemble, ready to be !
Prêt à être assemblé, prêt à être !
Listo para ensamblar, listo para ser !

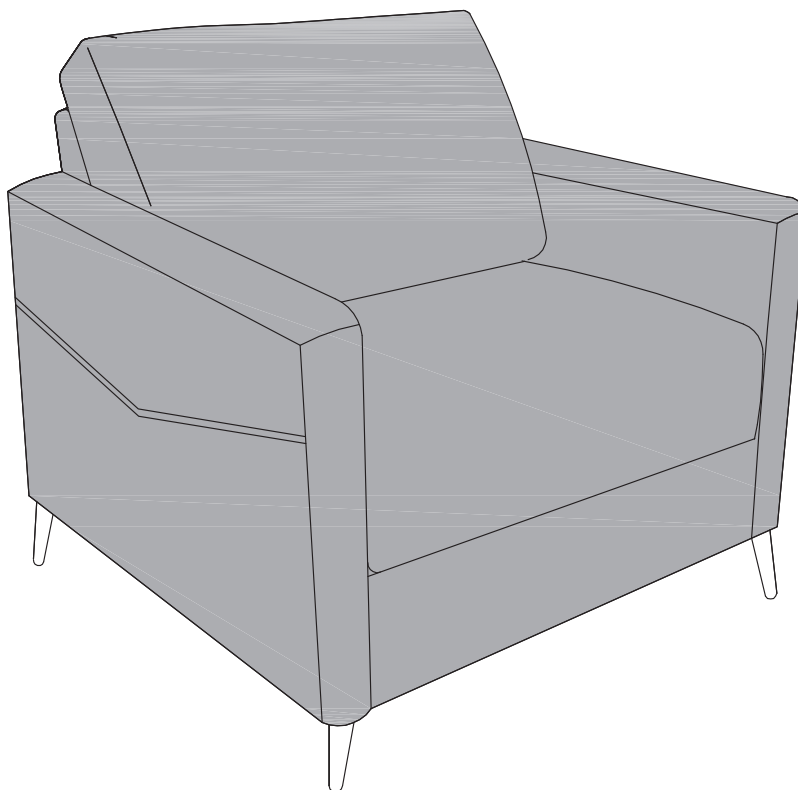

How can we help?

Comment pouvons-nous vous aider ?
¿ Cómo podemos ayudar ?



Give a call

Appelez-nous
Llámenos



Send an email

Envoyez-nous un courriel
Envíenos un correo electrónico



Start a chat

Clavardez avec nous
Inicia un chat

Canada / USA: 1-800-290-0465
Mexico : 001-800-514-5320 o al 800-522-6796

service@southshore.ca

www.southshorefurniture.com

**Damaged or missing part?
Need assistance for assembly?
Please contact us directly!**

South Shore is a family company based in Quebec. We design our own pieces, and make them in house, so we're never far away when you call us with a question or concern. Our team is in constant contact with our design, production and distribution teams, making it easy to find answers for you-whether it's a five-minute call or an hour-long tutorial on how to assemble a storage unit. When we put so much time into crafting our pieces, why would we put a limit on support?

Pièce brisée ou manquante? Besoin d'assistance pour l'assemblage? S'il vous plaît contactez-nous!

South Shore est une entreprise familiale basée à Québec. On conçoit nos propres produits. Constamment en contact avec nos équipes de conception, de production et de distribution, c'est facile pour nous d'obtenir les réponses à vos questions - que ce soit pour un simple appel de cinq minutes ou encore pour un tutoriel d'une heure afin de vous aider à assembler votre meuble. On consacre tellement de temps à la création de nos produits, ce serait fou de limiter notre accompagnement et notre service!

Esta danada o le falta alguna pieza? Necesita ayuda con el ensamble? Por favor contactenos directamente!

South Shore es una empresa familiar con sede en Quebec. Diseñamos nuestras propias piezas. El poder estar en constante contacto con nuestro equipo de diseño, de producción y de distribución, nos permite conseguir respuestas a todas sus preguntas, ya sea por una simple llamada de cinco minutos o incluso por un tutorial de una hora para ayudarlo a ensamblar sus muebles. Destinamos tanto tiempo a la creación de nuestros productos, que sería una locura limitar nuestro apoyo y nuestro servicio.

1-YEAR LIMITED WARRANTY

GARANTIE LIMITÉE DE 1 ANS / GARANTIA LIMITADA DE 1 AÑOS



Our furniture is like family to us. And we never turn our back on family.

Our commitment to our furniture -- and to you -- doesn't end the minute you've purchased the piece. We offer a 1-year warranty on all of our manufactured furniture pieces.

Nos muebles font partie de la famille. Et la famille, c'est pour la vie.

Notre engagement envers nos produits et envers vous ne prend pas fin au moment de l'achat. Nous offrons une garantie de 1 ans sur tous les produits que nous fabriquons.

Nuestros muebles son como una familia para nosotros y la familia, es para toda la vida.

Nuestro compromiso con nuestros muebles y con usted no termina al momento de la compra. Ofrecemos una garantía de 1 años en todos nuestros productos fabricados.

1-year limited warranty

South Shore Furniture products are warranted against defects in material and workmanship while owned by the "Original Purchaser". The term "Original Purchaser" is defined as that party or entity which purchases South Shore furniture from an authorized South Shore

Furniture retailer as shown by the original sales receipt. This warranty does not apply to "as is" or previously owned products.

South Shore Furniture warrants its products to be free from defects in materials and workmanship (normal wear and tear, fading and stretching excepted), for one year from the date of purchase, except as provided below under the limited warranty.

The exceptions or exclusions to this warranty are as follows :

1. Any warranty claim that is submitted after the limited warranty period, or without proper proof of purchase.
2. This warranty shall not apply to South Shore Furniture products which have been subjected to misuse, neglect, alteration, modification, or attachments, either caused by the original purchaser, shipping, storage, accident, fire,

Garantie limitée d'un an

Les meubles South Shore sont garantis pièces et main-d'œuvre tant qu'ils seront en la possession de « l'acheteur initial ». « L'acheteur initial » est défini comme une personne ou entité qui a acheté un meuble South

Shore d'un détaillant autorisé Meubles South Shore comme le démontre le reçu de caisse d'origine. Cette garantie ne s'applique pas aux items vendus tels quels ni aux items usagés.

Meubles South Shore garantit que ses produits sont exempts de défauts de pièces et de main-d'œuvre (à l'exception de l'usure normale, de la décoloration et de l'étirement), et ce, pendant un an à compter de la date d'achat, à l'exception des conditions suivantes de la garantie limitée.

Les exceptions ou exclusions de cette garantie vont comme suit :

1. Toute réclamation sous garantie soumise après la fin de la période de garantie limitée, ou sans preuve d'achat.
2. Cette garantie ne s'applique pas aux produits Meubles South Shore qui ont fait l'objet d'un mauvais usage, de négligence, d'altération, de modification ou d'ajout, soit par l'acheteur initial, soit en raison du transport, de l'entreposage, d'un accident, d'un feu, de l'eau ou de catastrophes naturelles. Dans l'éventualité d'un défaut de pièces ou de main-d'œuvre couvert par cette garantie, Meubles South Shore réparera, remplacera ou remboursera, à sa discrétion et sans frais, l'item garanti dans un délai raisonnable. Nous nous réservons le droit de réclamer que les pièces défectueuses nous soient retournées

Garantía limitada por 1 año

Los muebles de South Shore están garantizados contra defectos en el material o en la mano de obra mientras sigan en posesión del "Comprador Original". El término "Comprador Original" se entiende como aquella parte o entidad que adquiere muebles de nuestra marca South Shore Muebles con un distribuidor autorizado de South Shore Muebles así demostrado en el recibo original. Esta garantía no aplica para productos comprados "como tales" o previamente adquiridos.

Los productos de South Shore Muebles garantizan estar libres de defectos en los materiales o en la mano de obra (exceptuando el desgaste normal en la tela, descoloramiento y estiramiento común), por un año desde la fecha de compra, excepto como se menciona a continuación dentro de la garantía limitada.

Las excepciones y exclusiones de esta garantía son las siguientes:

1. Cualquier reclamo de garantía que sea sometido después del periodo de la garantía limitada o sin prueba apropiada de compra.
2. Esta garantía no aplicará a productos South Shore Muebles que hayan sido sometidos a mal uso, negligencia, alteraciones, modificaciones o aditamentos, ya sea causados por el Comprador Original, envío, almacenaje, accidente, fuego, inundación o actos de Dios.

En el caso de un defecto en el material o en la mano de obra cubierto por esta garantía, South Shore Muebles reparará, reemplazará o reembolsará el mueble garantizado, a su discreción, sin ningún cargo dentro de un lapso de tiempo razonable. Nos reservamos el derecho

flood, or acts of God.

In the event of a defect in material or workmanship covered by this warranty, South Shore Furniture will repair or replace or refund, at their discretion, without charge the warranted furniture within a reasonable amount of time. We reserve the right to require damaged parts to be returned to us upon request.

For claims or questions concerning this warranty, please contact South Shore Furniture Customer Service Department : 1-800-290-0465

Be prepared to provide your name, address, phone number, the model and purchase order number of the product, date of purchase, and the store where it was purchased. South Shore Furniture requires that the original sales receipt be submitted with all requests to confirm that you are the original purchaser according to our written warranty.

sur demande.

Pour toute question ou réclamation concernant cette garantie, veuillez communiquer avec le service à la clientèle de Meubles South Shore : 1-800-290-0465

Vous aurez besoin des informations suivantes : votre nom, adresse, numéro de téléphone, modèle du produit et numéro de commande, date et lieu de l'achat. Meubles South Shore exige que le reçu de caisse d'origine soit soumis pour toute demande afin de confirmer que vous êtes l'acheteur initial tel que défini dans notre garantie écrite.

de requerir que las partes dañadas sean devueltas según se soliciten.

Para reclamos o preguntas concernientes a esta garantía, favor de contactar al Departamento de Servicio de Atención al Cliente de South Shore Muebles: 1-800-290-0465

Esté preparado para proporcionar su nombre, dirección, número telefónico, modelo y número de orden de compra del producto, fecha de compra y la tienda en donde fue hecha la compra. South Shore Muebles requiere que el recibo original sea sometido con todas las peticiones para confirmar que sea usted el comprador original de acuerdo a nuestra garantía escrita.

1

Collect the pieces together

Rassembler les morceaux ensemble / Poner las piezas juntas

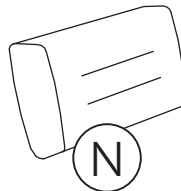
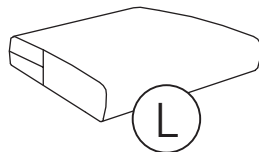
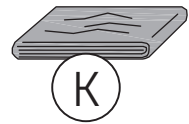
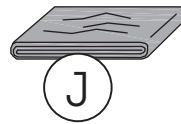
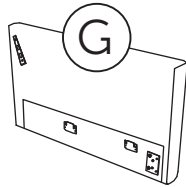
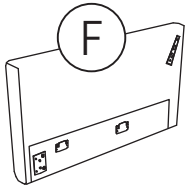
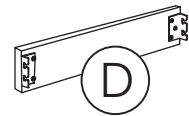
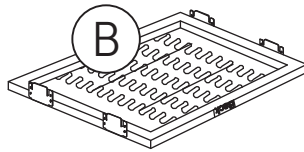
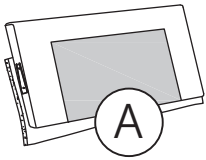
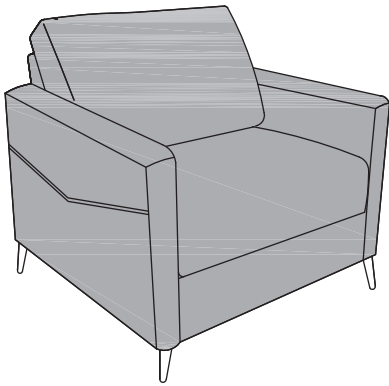

2

Let's get handy!

Mettons-nous au travail! / ¡Vamos a ponernos prácticos!

01

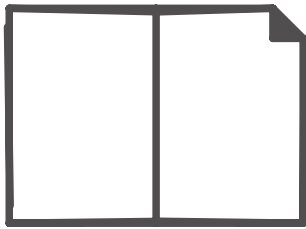

02

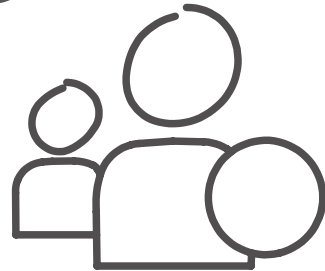

03

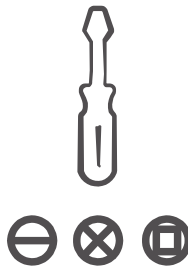
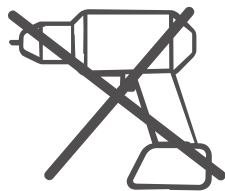

04

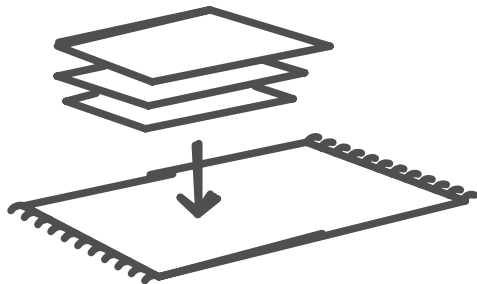

05



3

Collect the Hardware

Rassembler la quincaillerie / Reunir los artículos de ferreteria

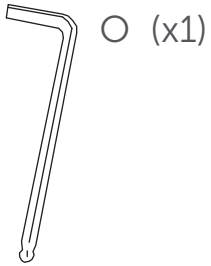
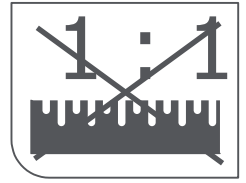
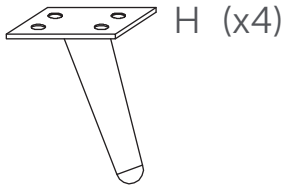

*Hardware package may have spare parts.

*Le sac de quincaillerie peut contenir des pièces de remplacement.

*La bolsa de herraje puede contener piezas adicionales de repuesto.

4

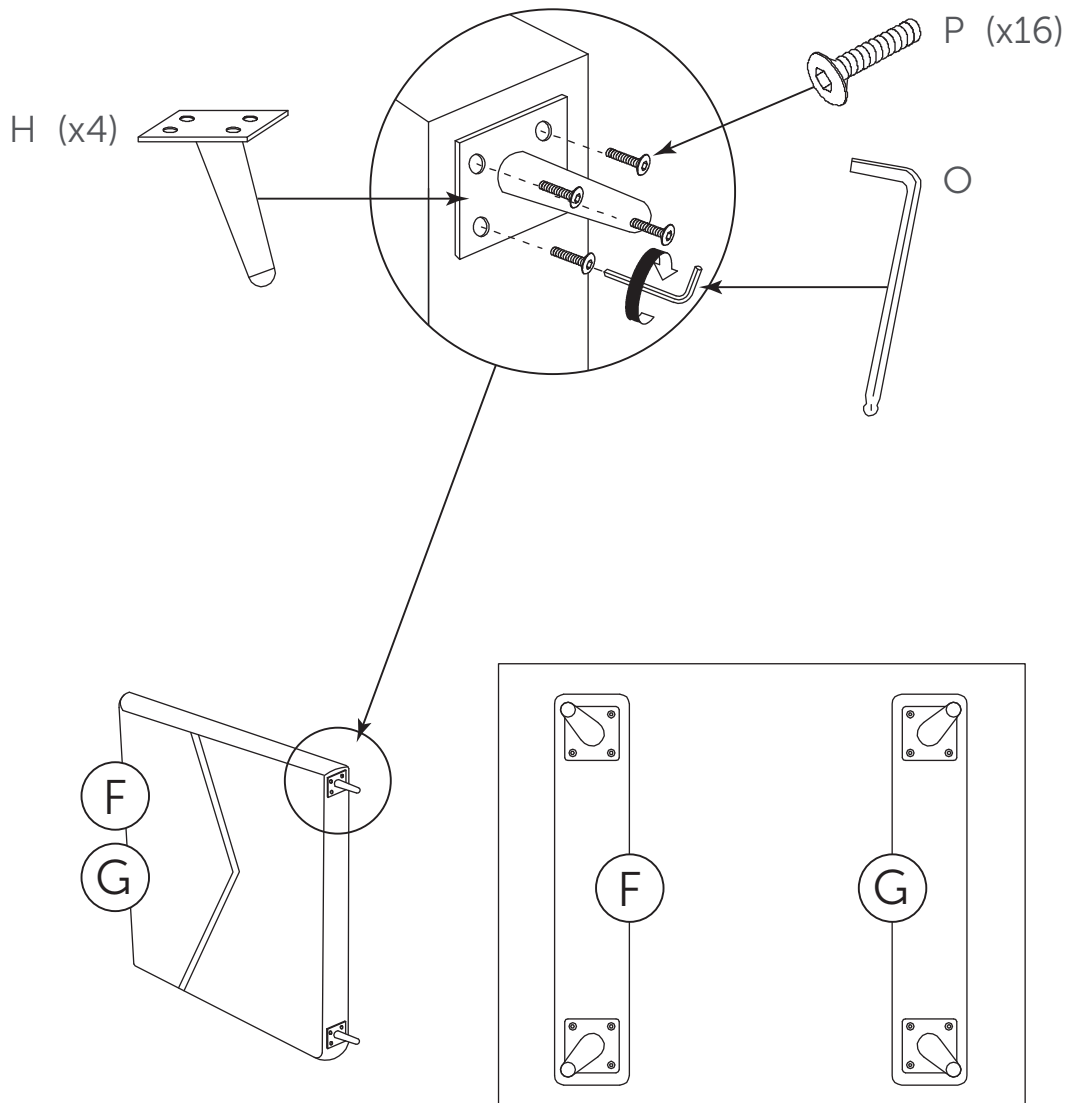

5

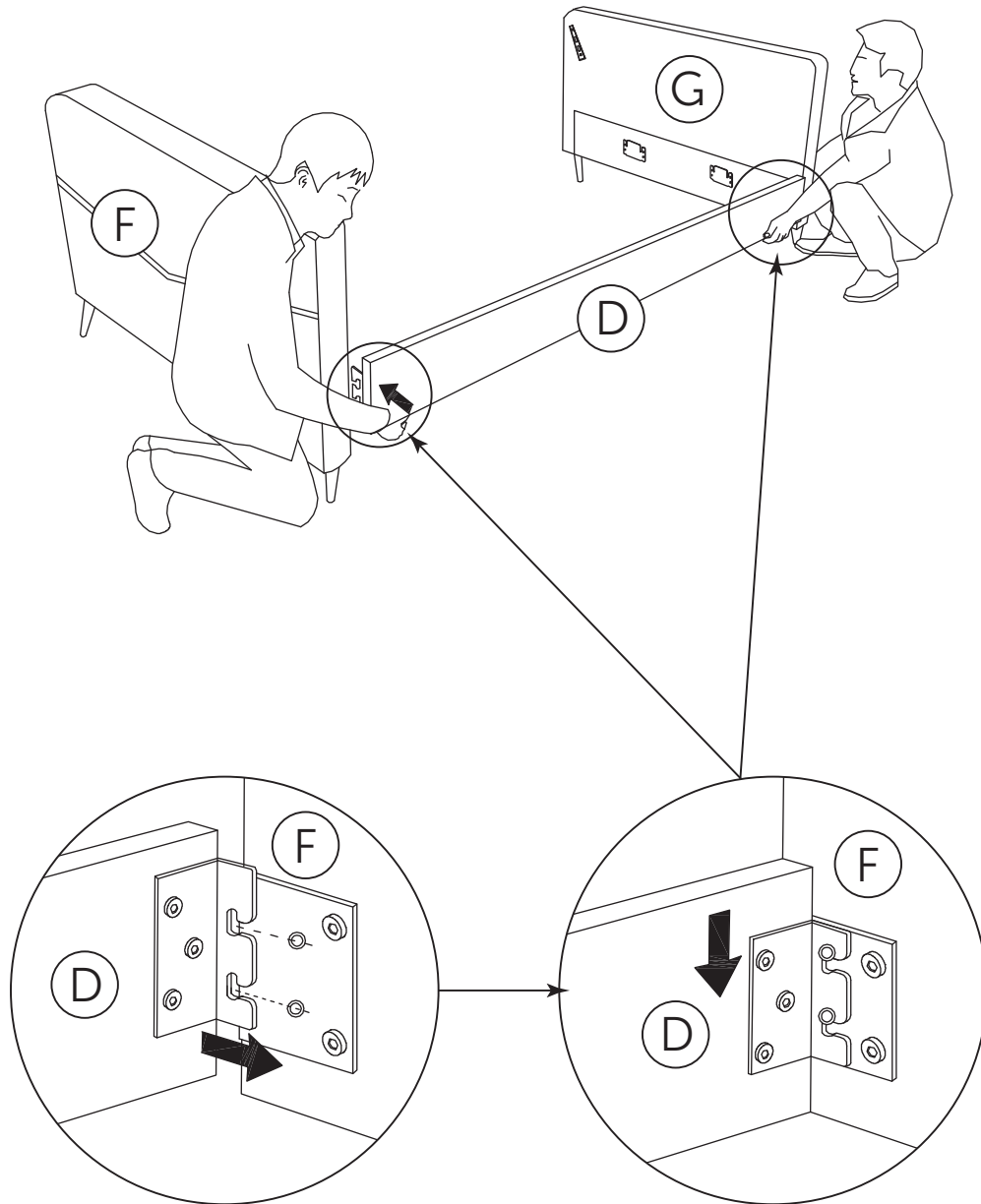

6

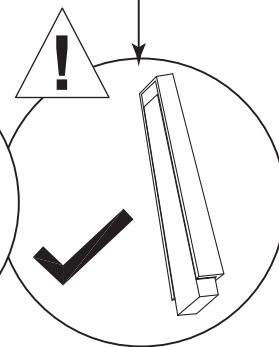
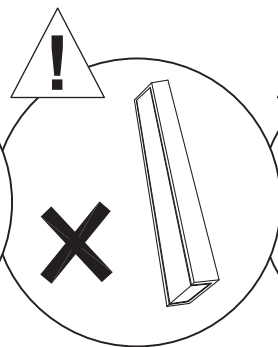
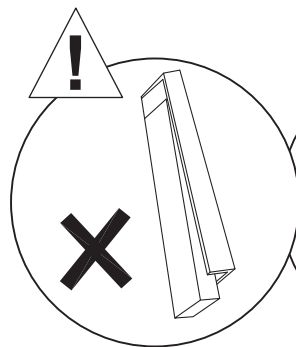
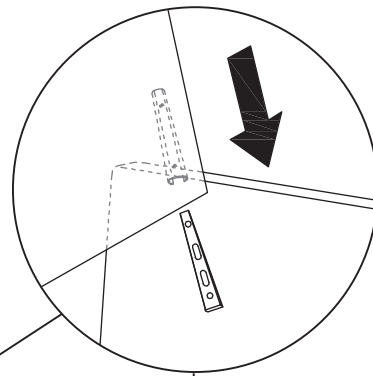
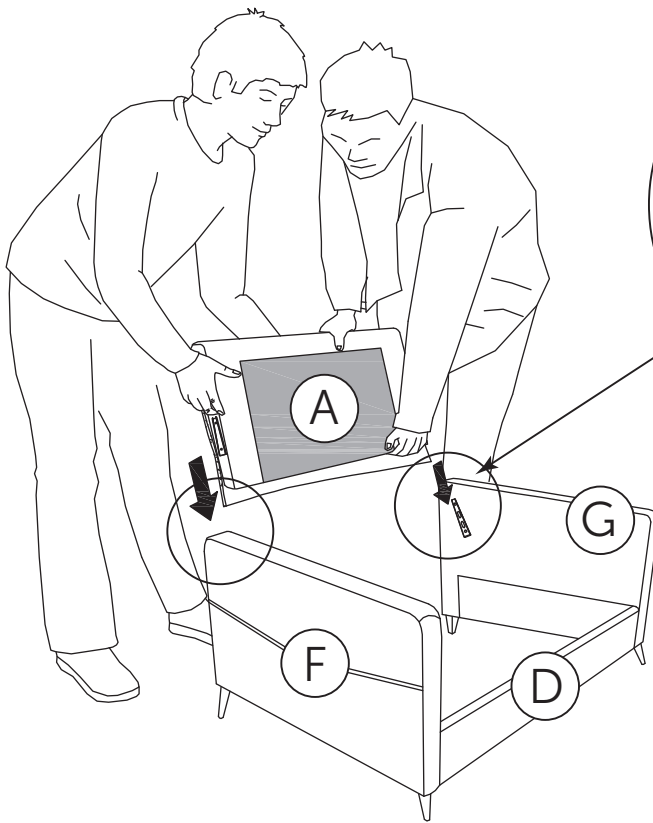
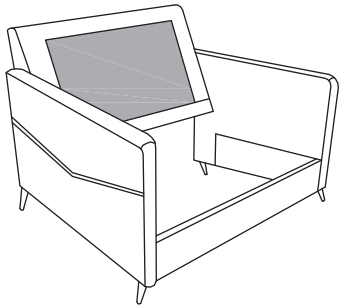

7

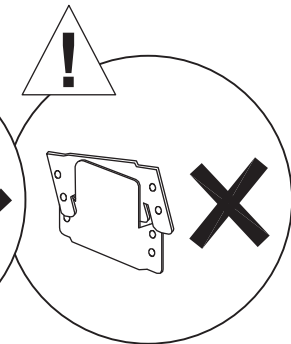
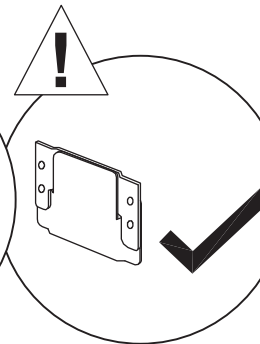
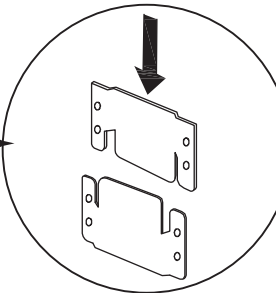
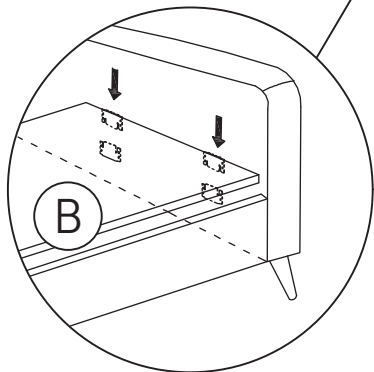
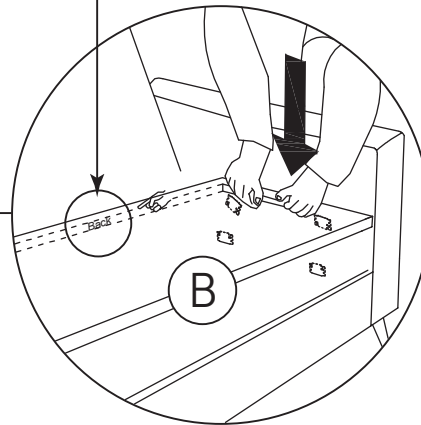
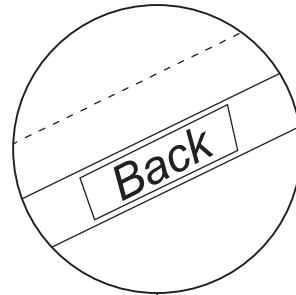
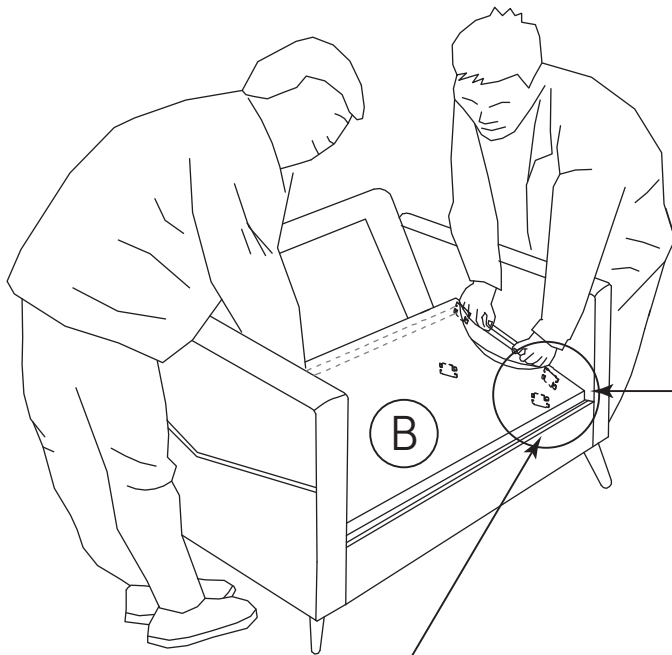
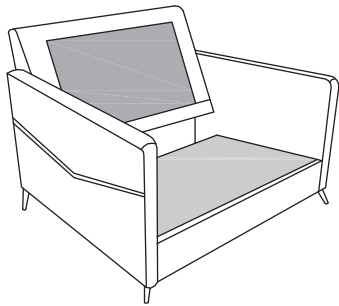

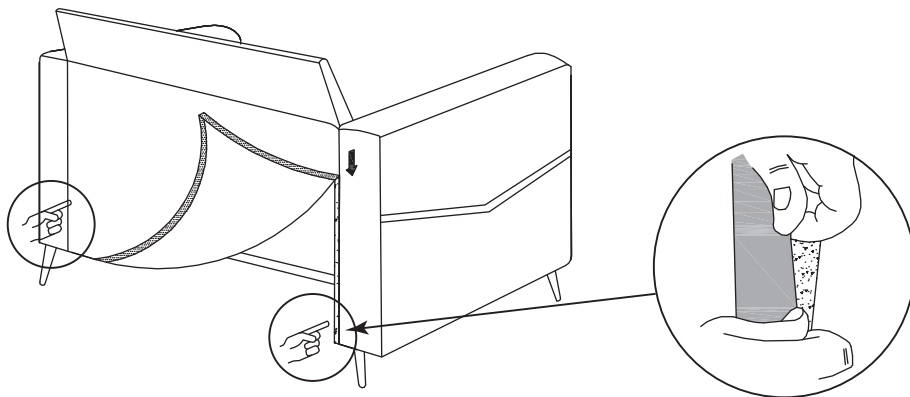
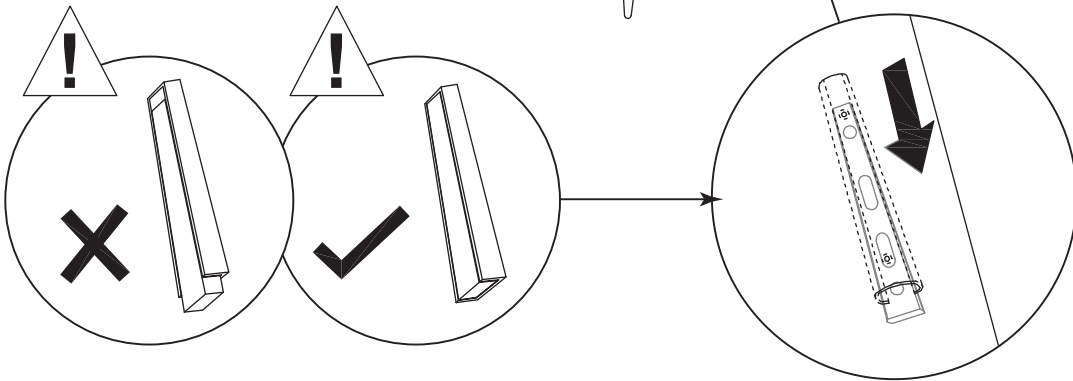
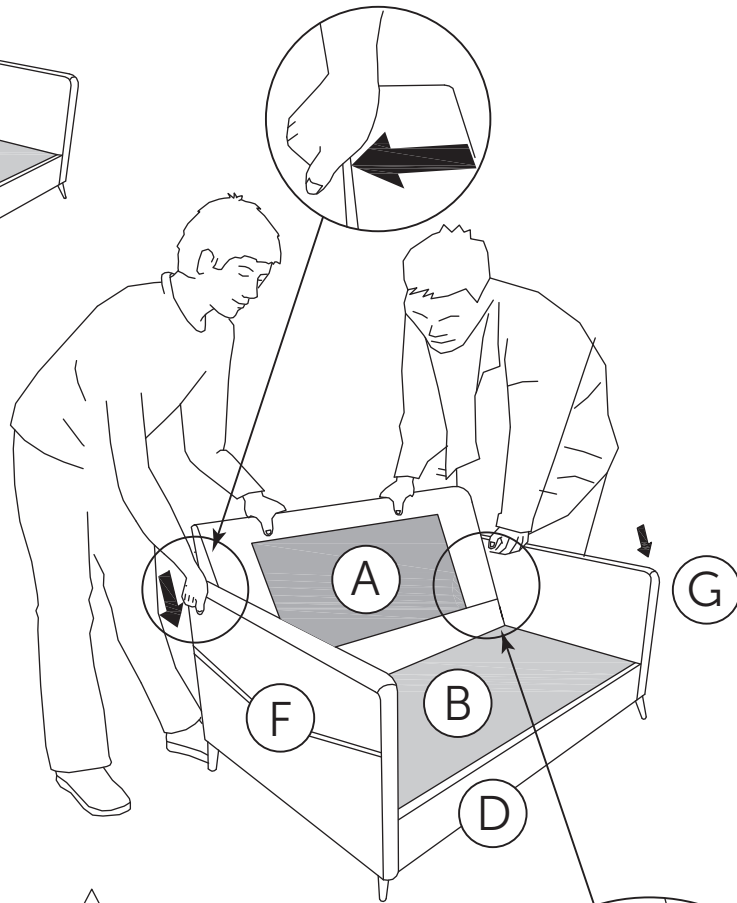
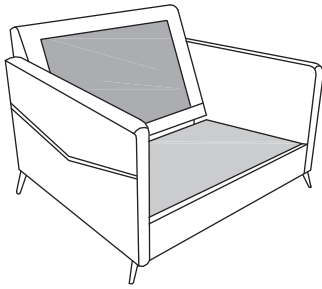

9

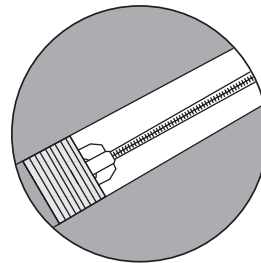
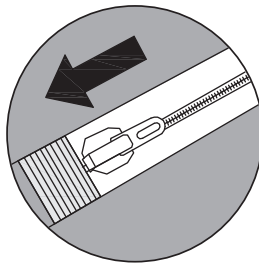
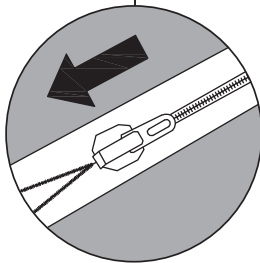
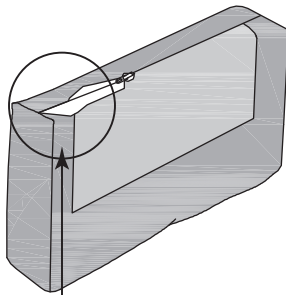
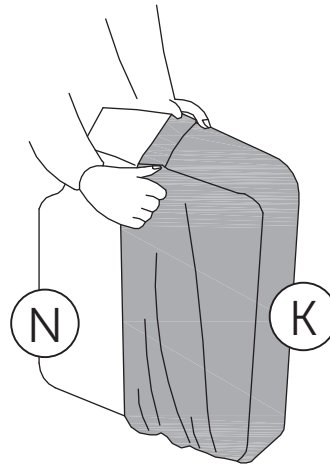
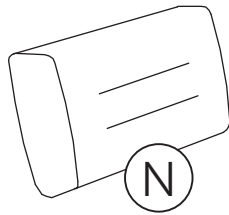
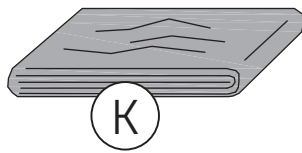
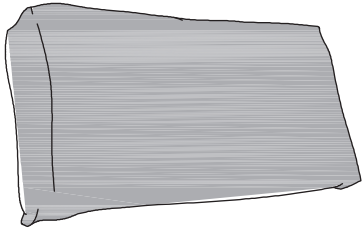

10

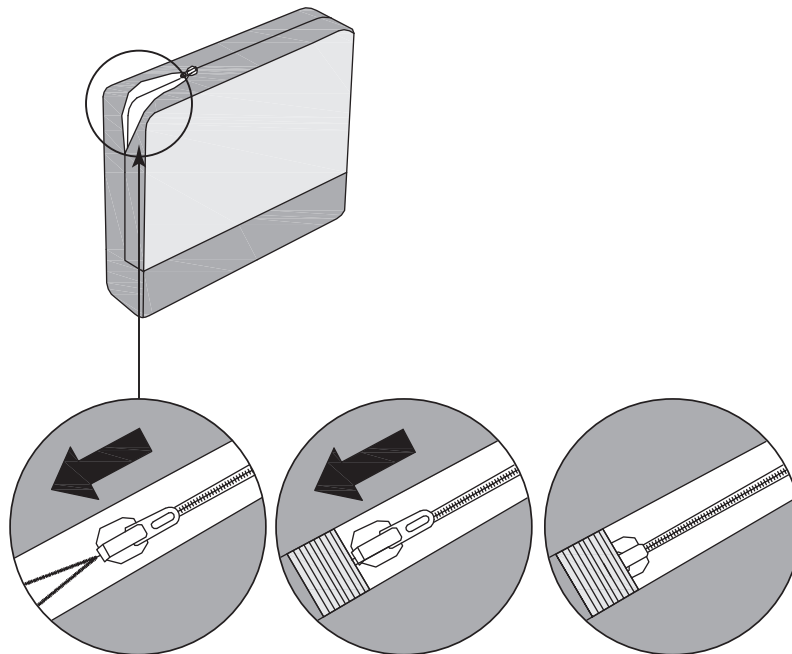
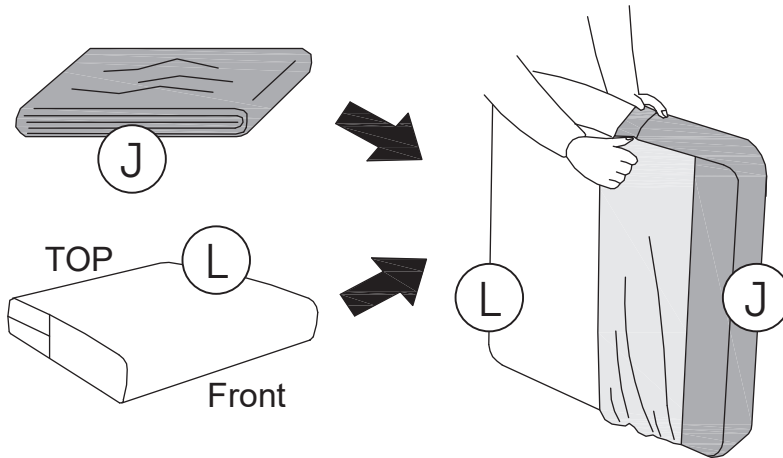
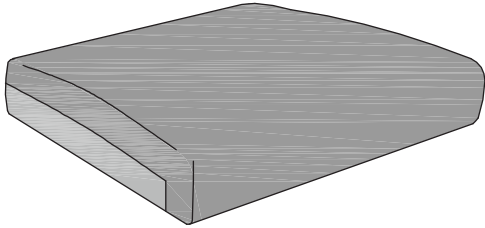

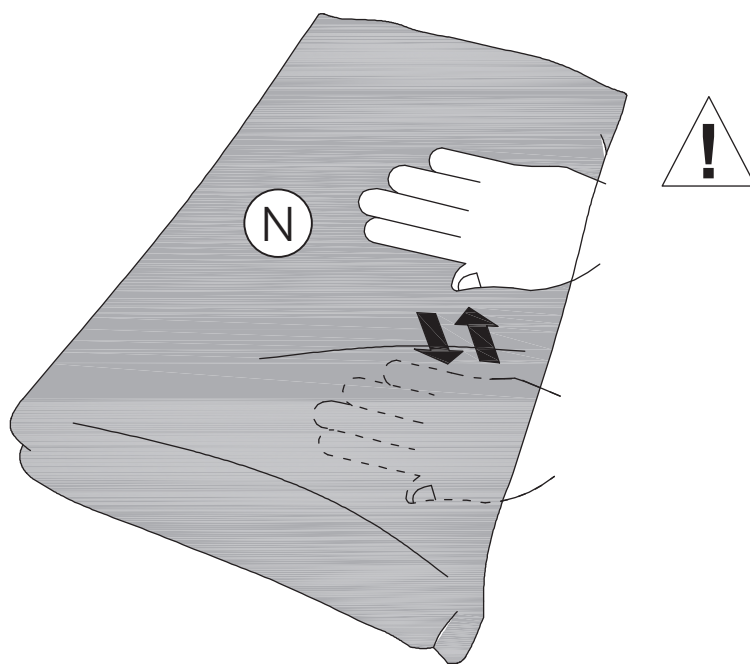

12

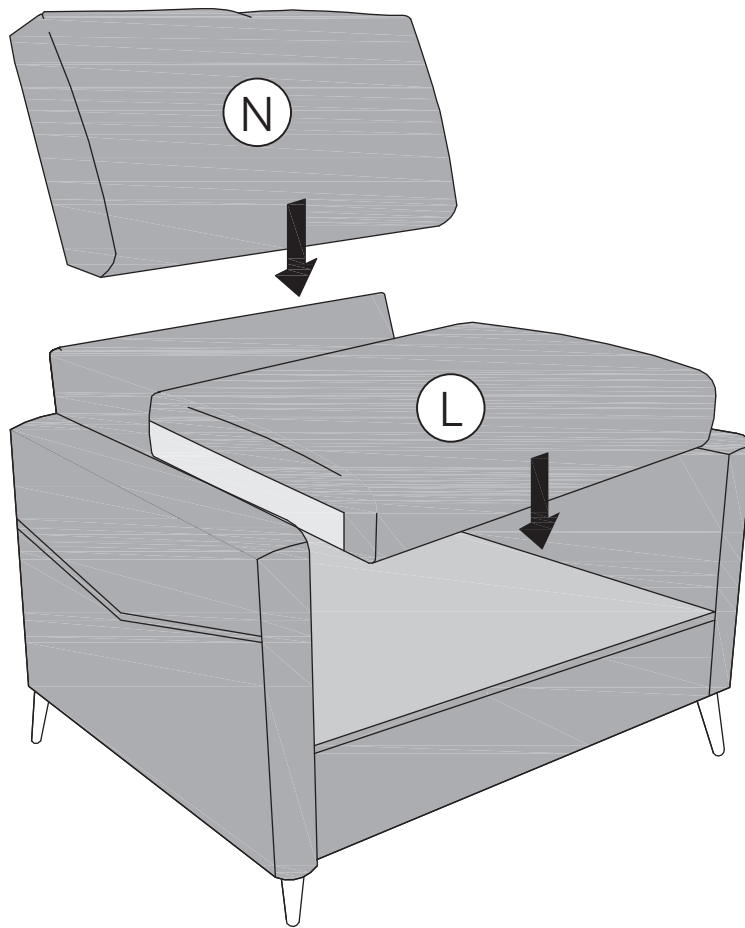

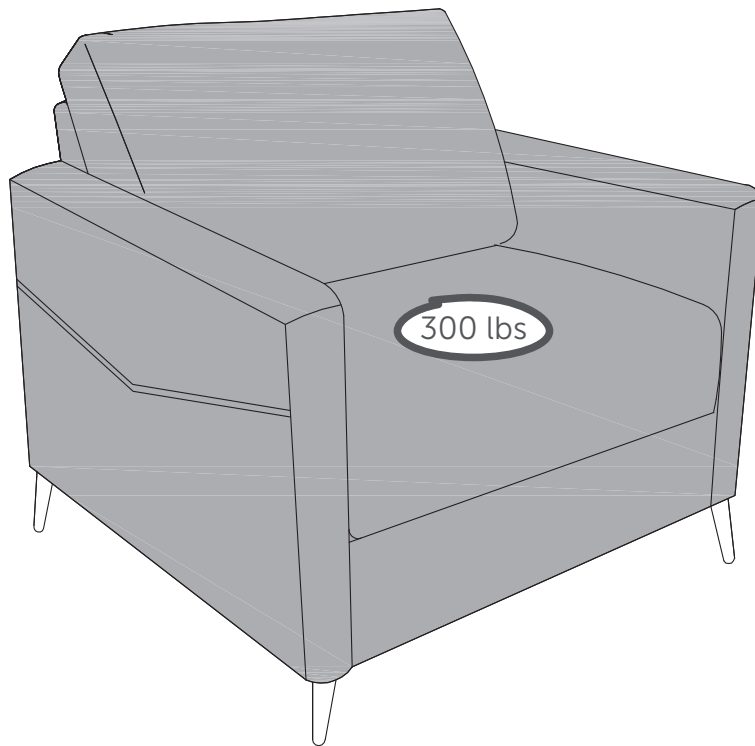

This South Shore Industries product is designed to withstand the weight indicated on the plan. We are not responsible for the breakage of parts or any injury caused by the failure to comply with this recommendation.

Ce produit de Meubles South Shore a été conçu pour résister aux poids mentionnés ci-contre. Nous ne sommes pas responsable du bris des pièces ou de toute blessure occasionnée par le non-respect de cette recommandation.

Este producto las Industrias South Shore ha sido concebido para resistir el peso que se menciona aquí. No somos responsables del daño de piezas o cualquier otra lesión ocasionada por el no respeto de esta recomendación.

MAINTENANCE TIPS

CONSEIL D'ENTRETIEN / CONSEJOS DE MANTENIMIENTO

MAINTENANCE TIPS

- Do not wash
- Iron on low heat
- Dry clean on low heat
- Do not tumble dry
- Do not bleach
- Spot clean only

CONSEILS D'ENTRETIEN

- Ne pas laver
- Repasser à basse température
- Nettoyer à sec à basse température
- Ne pas sécher par culbutage
- Ne pas javelliser
- Nettoyer seulement les taches

CONSEJOS DE MANTENIMIENTO

- No lavar
- Planchado a baja temperatura
- Lavado en seco a baja temperatura
- No usar secadora
- No usar blanqueador
- Limpieza localizada únicamente

You're our inspiration and we ♥ hearing from you!

Give us a call if you want to discuss a project. Or hop over to our social media platforms and share your design stories.

The door is always open.

#southshorehome



Take a look at our website: we have tons of ideas to go with your new piece of furniture!

www.southshorefurniture.com

Want to take sneak peek at new arrivals and get some useful tips?
Subscribe to our newsletter!

Vous êtes notre inspiration et nous ♥ recevoir de vos nouvelles!

Appelez-nous si vous voulez discuter d'un projet ou rejoignez nos médias sociaux pour partager vos histoires de design.

Notre porte est toujours ouverte.

#southshorehome



Jetez un coup d'oeil à notre site internet. Nous avons des tonnes d'idées pour votre nouveau meuble !

www.southshorefurniture.com

Vous voulez avoir un aperçu de nos nouveaux arrivages et obtenir des conseils pratiques?
Inscrivez-vous à notre infolettre!

Usted es nuestra inspiración y nos ♥ tener noticias de usted.

Llámenos si desea discutir de su proyecto o síganos en nuestras redes sociales y comparta sus historias de diseño.

La puerta siempre está abierta para usted.

#southshorehome



¡ Lo invitamos a echar un vistazo en nuestro sitio web, tenemos toneladas de ideas para su nuevo mueble !

www.southshorefurniture.com

¿ Quiere echar un vistazo a nuestras novedades y consejos prácticos ?
Suscribase a nuestro boletín.

Make room for what matters

South  *Shore*

Place à la vraie vie

southshorefurniture.com