

NOTES:

1 OPEN DOOR VIEW INCLUDES HINGE SPACE OFFSET.

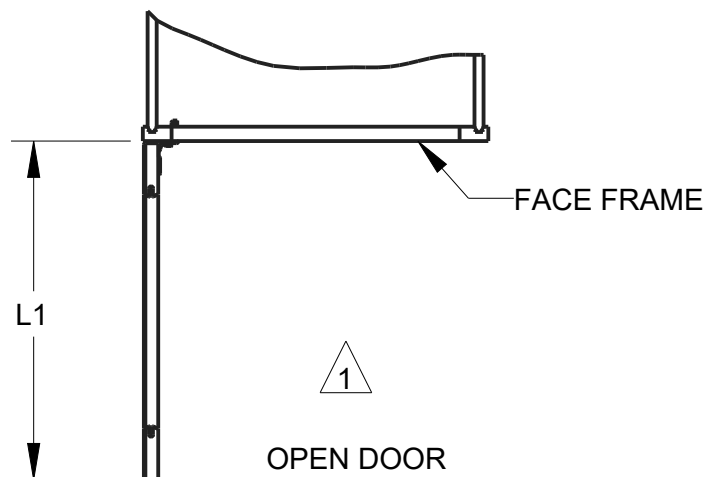
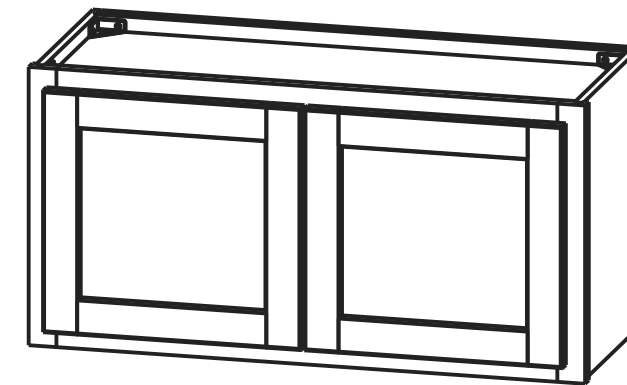
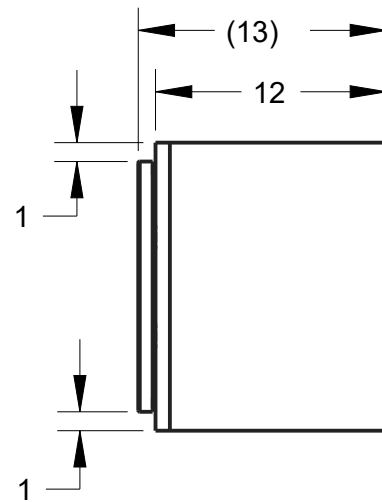
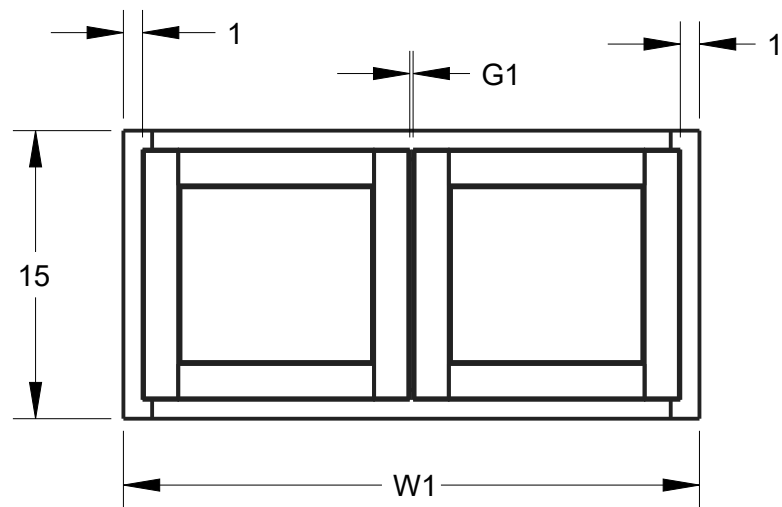

PRODUCT	W1	L1	G1	DOOR SIZE
			ROUNDED TO THE NEAREST 1/32	
W3015	30"	14 1/16"	(3/16")	13 29/32" X 13 1/32"
W3315	33"	15 9/16"	(3/16")	15 13/32" X 13 1/32"
W3615	36"	17 1/16"	(3/16")	16 29/32" X 13 1/32"
W3915	39"	17 11/16"	(2")	17 17/32" X 13 1/32"

THIRD ANGLE PROJECTION



MATERIAL

FINISH

N/A

N/A

DRAWN BY
ANDY BROWN

DATE
03MAR2021

DESIGNED BY
NORTHPOINT

DATE

APPROVED BY
E. GOLESTANYAN

DATE
26MAR2021

**hardware
resources**

DESCRIPTION

W3915, W3615, W3315, W3015 HALF
OVERLAY

DRAWING NUMBER
W3915-W3615-W3315-W3015_HALF

REV
A

SIZE
A3

SCALE
0.100

SHEET
1 / 1

PRODUCT SHOWN W3015

DOCUMENT STATUS Released

HARDWARE RESOURCES RESERVES THE RIGHT TO CHANGE SPECIFICATIONS WITHOUT NOTICE.
IN CASE OF A DISCREPANCY, ACTUAL PART GEOMETRY SUPERSEDES THIS DOCUMENT.

THE INFORMATION CONTAINED WITHIN THIS DRAWING IS THE SOLE PROPERTY OF HARDWARE RESOURCES INC. ANY
REPRODUCTION IN PART OR WHOLE WITHOUT WRITTEN PERMISSION OF HARDWARE RESOURCES INC. IS PROHIBITED.