

9230279 20x9.5 Arcadia MOSQUITO MESH KIT LOADING DIAGRAM

(40 sets/pallet A, 30 sets/pallet B ,total 20 Pallet A, 2 Pallet B, 860sets, gross weight: 16770Kg)

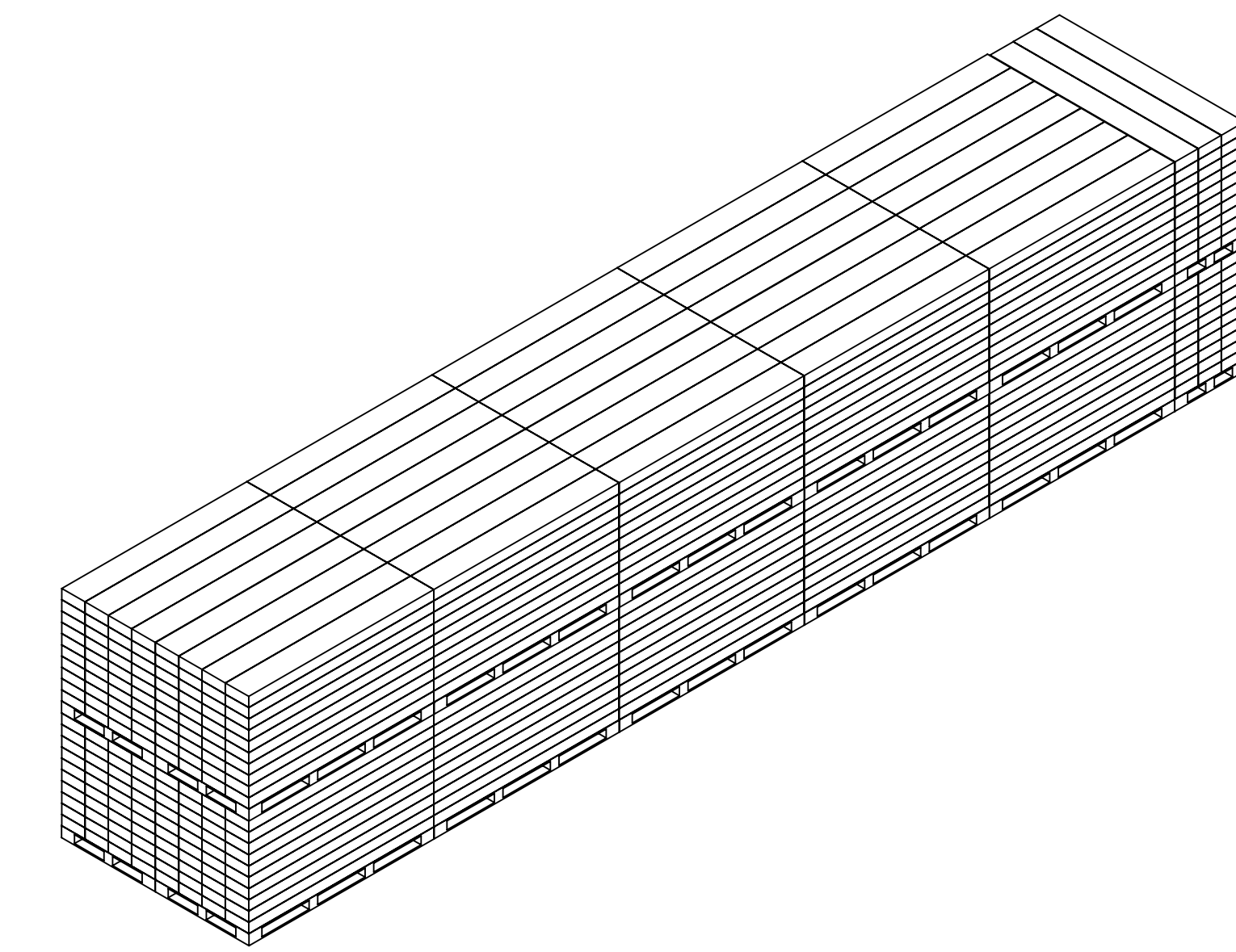
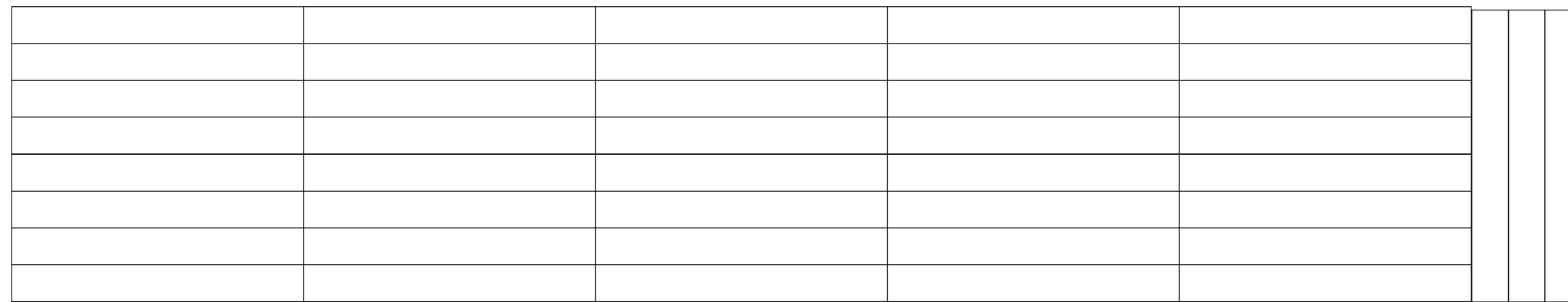
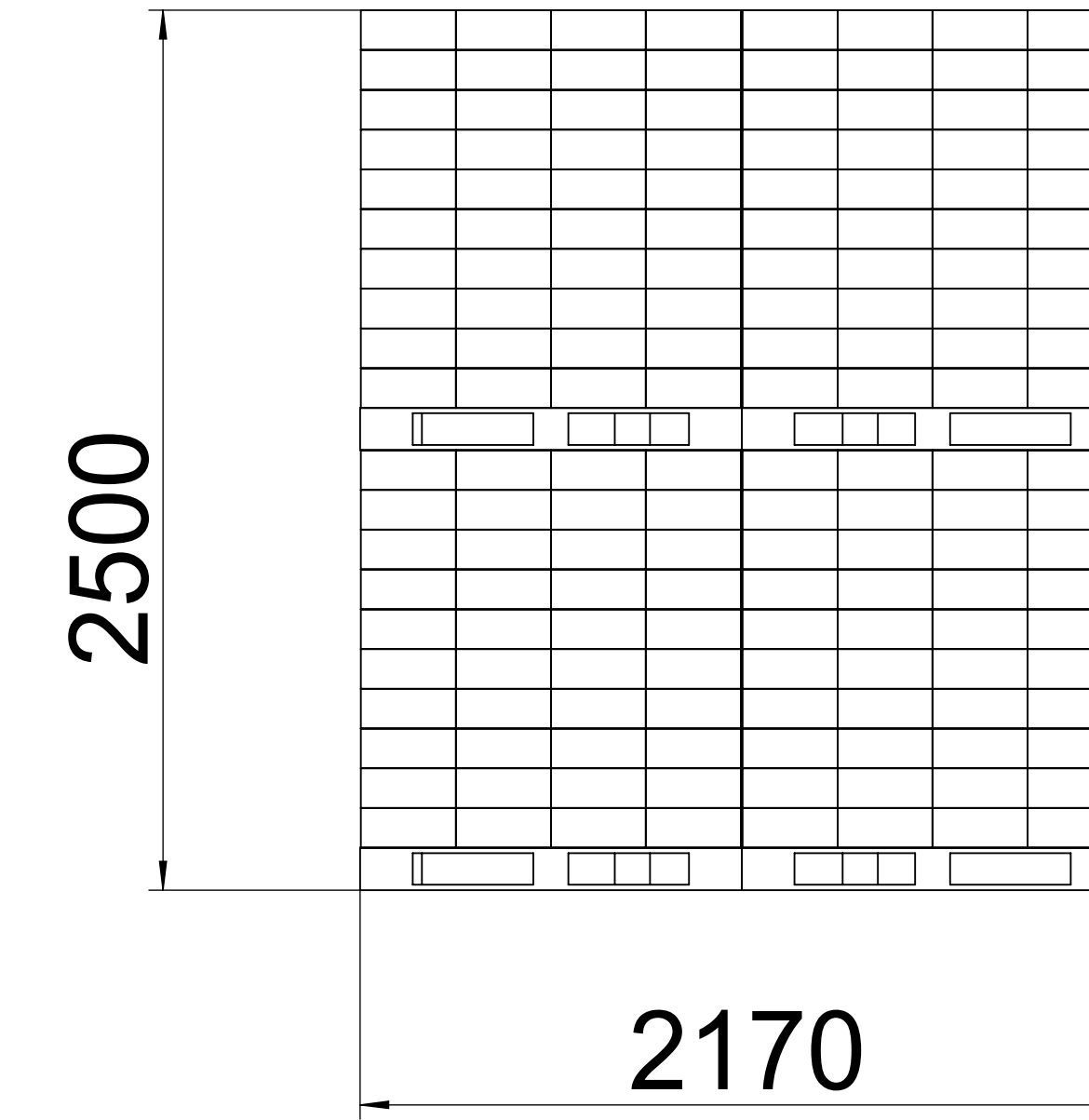
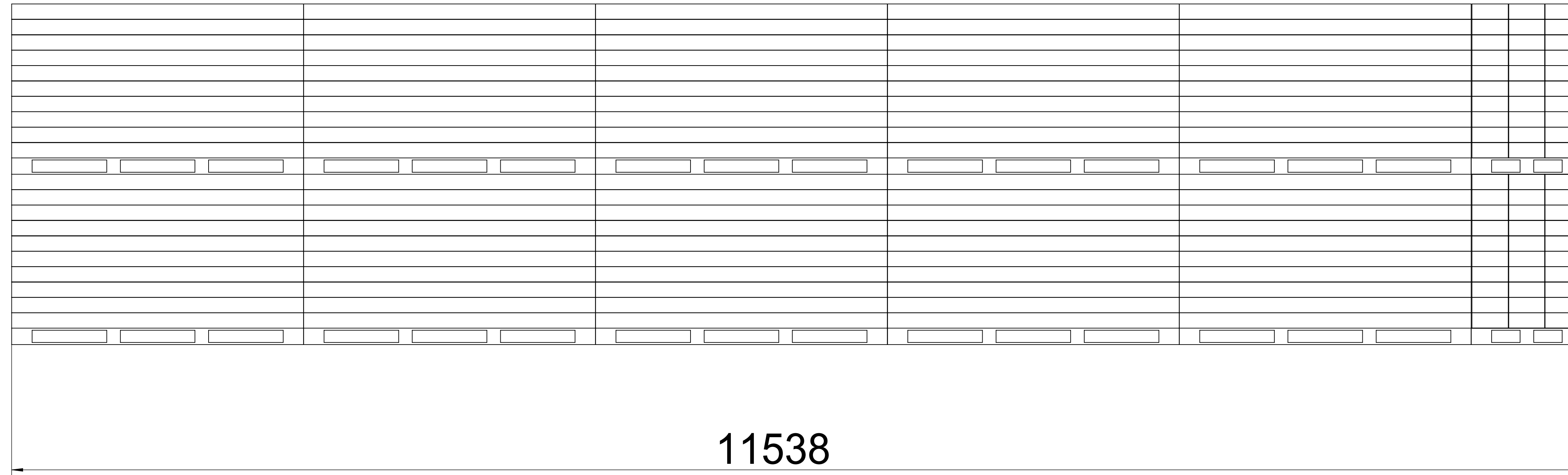

零件代号
物料编码/物料名称
插图
插表
材料图号
原图点号
签字
日期

标记	类别	分区	更改文件号	签名	年月日	阶段	标记	重量	比例	"图样名称"
设计			标准					84724828	1:50	"图样名称"
校核			工艺							"图样名称"
主管设计			审核							"图样名称"
			批准							"图样名称"
共1套 第1套								版本	修改	

Pallet A Details, 40 sets/pallet

A

A

B

B

C

C

D

D

1

2

3

4

5

6

1

2

3

4

5

6

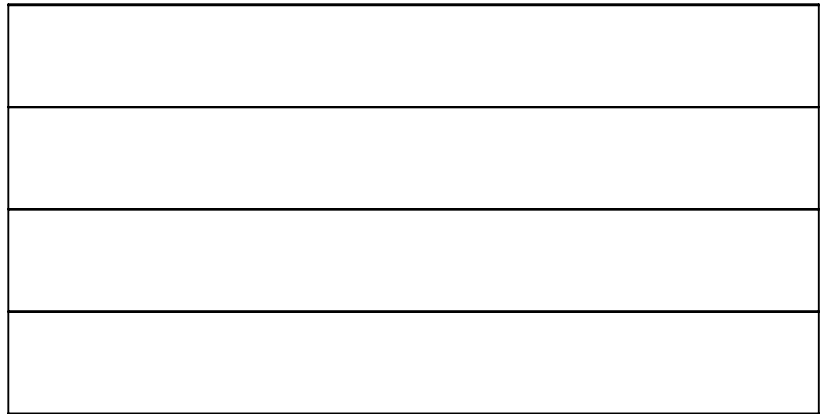
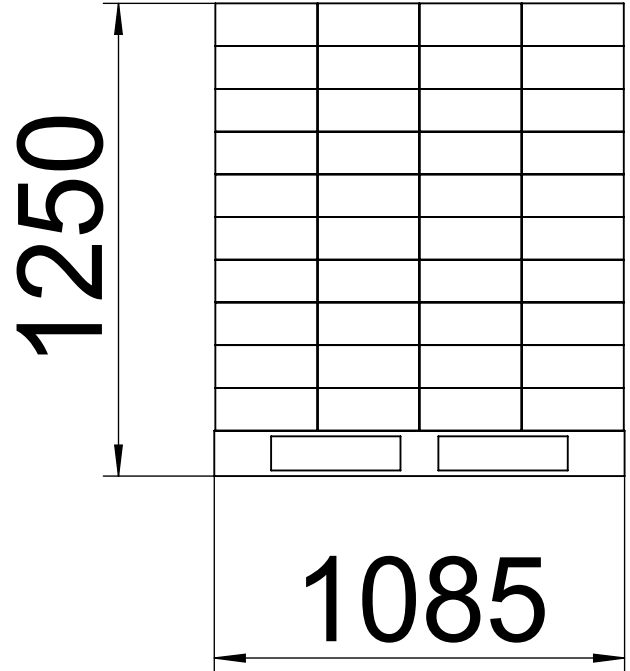
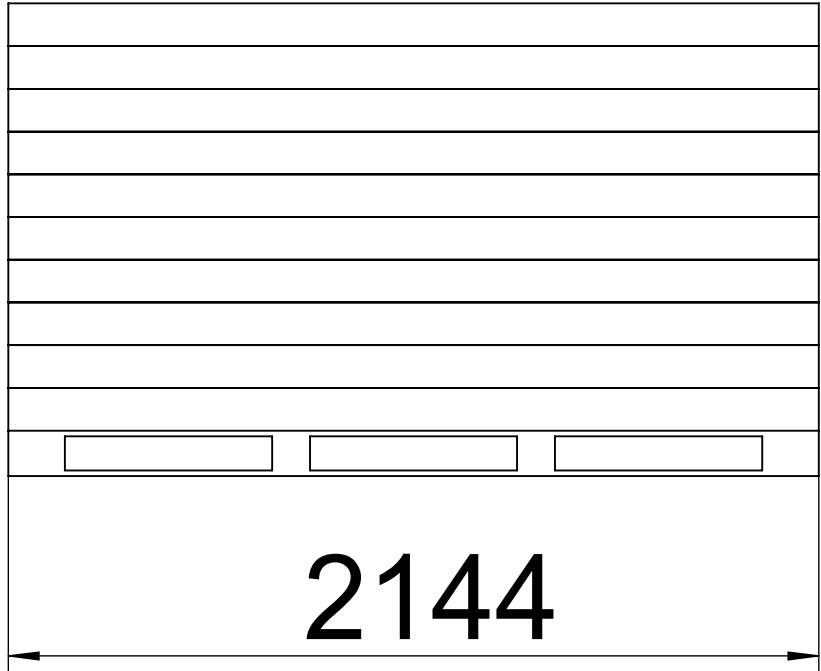

Pallet B Details, 30 sets/pallet

A

A

B

B

C

C

D

D

1

2

3

4

5

6

1

2

3

4

5

6

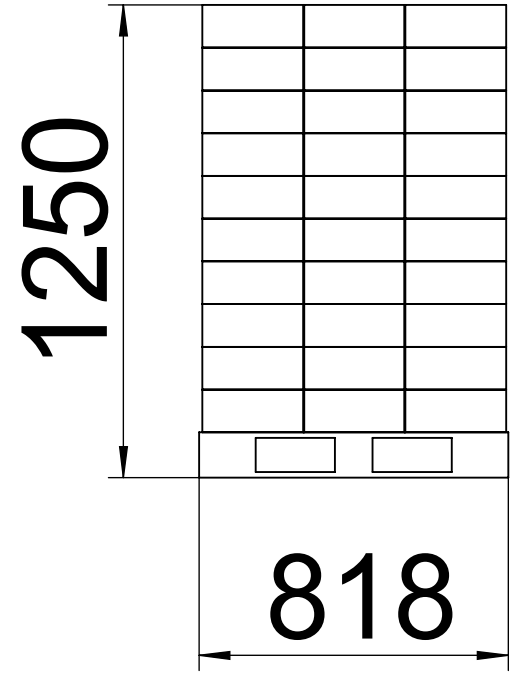
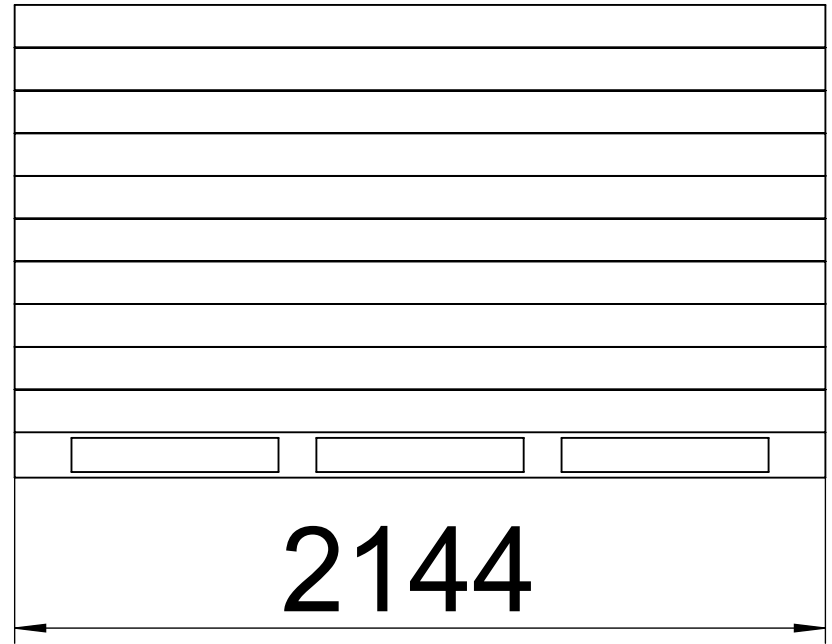

Carton Details

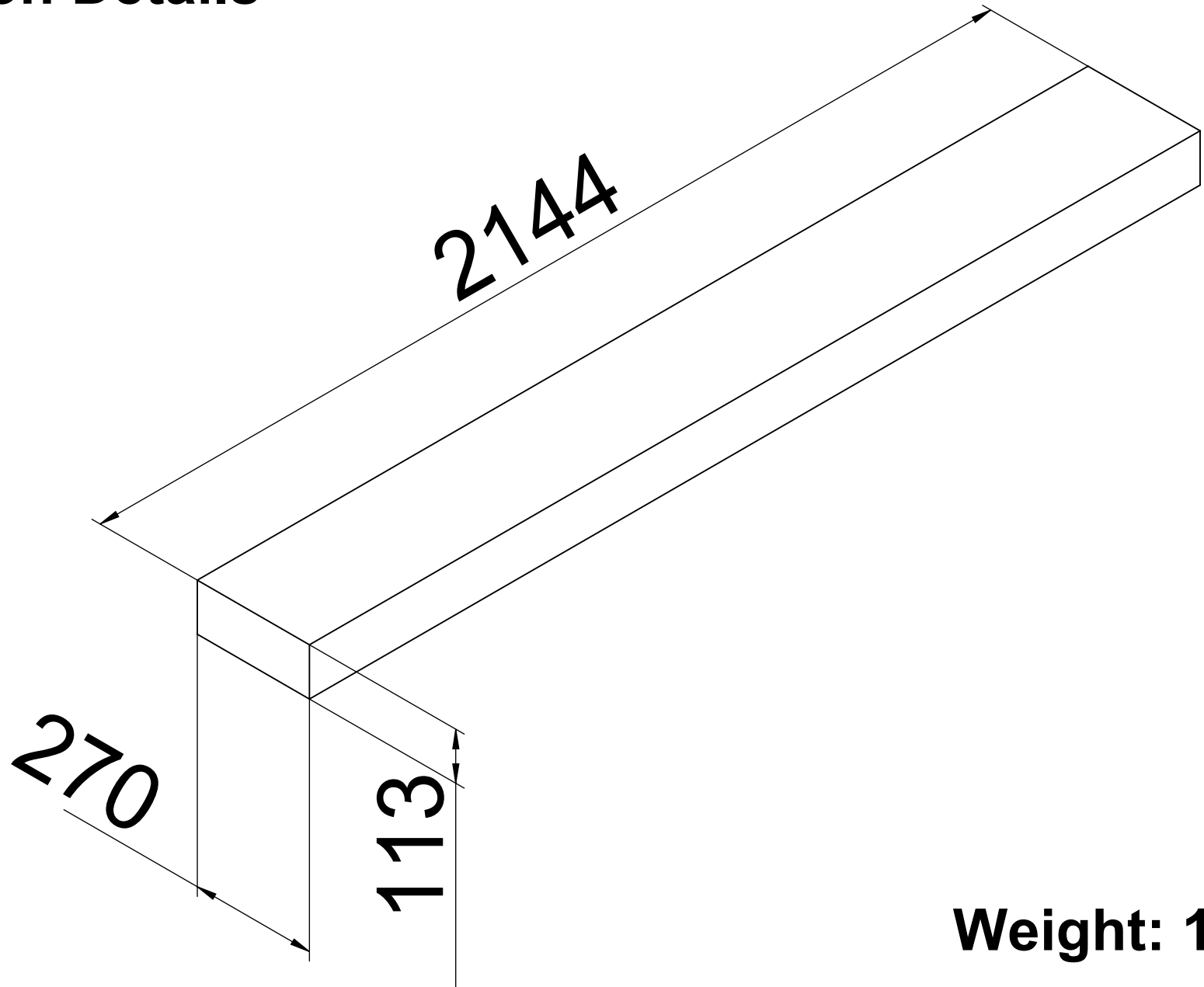

Weight: 19.5 Kg