



Safety **1ST**

Grow and Go™

8-in-1 Stroller

Max 50 lb (22.7 kg)

Read all instructions BEFORE USING this product.

KEEP INSTRUCTIONS FOR FUTURE USE.

4358-8199 8.27.21

Safety Information

WARNING:

FOR THE SAFETY OF YOUR CHILD, PLEASE READ THE FOLLOWING WARNINGS AND ASSEMBLY INSTRUCTIONS AND KEEP FOR FUTURE REFERENCE.

- Adult assembly required.
- **NEVER LEAVE CHILD UNATTENDED. ALWAYS** keep child in view when in stroller.
- **AVOID SERIOUS INJURY** from falling or sliding out. **ALWAYS** use the harness system. Check frequently to make sure it is secure.
- **ALWAYS** keep fingers away from moving parts, when folding, unfolding or adjusting stroller to prevent finger entrapment.
- **ALWAYS** make sure stroller is **FULLY OPEN AND LOCKED** before using.
- **ALWAYS** use the brakes when stroller is stopped.
- **ALWAYS** remove protective material and poly bags and dispose before assembly.
- **NEVER** put hot liquids in the cup holder.
- Parent tray, including the cup holders, **CANNOT** exceed 3 lbs (1.4 kg) total.
- **NEVER** use stroller on stairs or escalators.
- **NEVER** rollerblade with stroller.
- **NEVER** allow children to play with or hang onto the stroller.
- **NEVER** allow children to climb into the stroller unassisted. Stroller may tip over and injure child.

- **NEVER** place or hang parcels, bags, or accessories on the handle or canopy. The stroller may tip over or the canopy may collapse.
- This product will become unstable if a parcel bag or rack is used when there is no provision for one.
- This product may become unstable if a parcel bag, other than the one recommended by the manufacturer is used.
- This product will become unstable if the manufacturer's recommended load is exceeded.
- Care must be taken when folding and unfolding the stroller to prevent finger entrapment.
- Child may slip into leg openings and strangle, unless you disengage buckle under the foot rest and press down the foot area to create safe enclosure.
- **DO NOT** carry additional children, goods, or accessories in or on this product except as recommended in the manufacturer's instructions.
- **NEVER** place more than 10 lb (4.5 kg) in the storage basket. If weight is exceeded, hazardous unstable conditions may exist.
- **STROLLER** is only for use with children up to 50 lb (22.7 kg), and **WHEN SEATED**, the midpoint of your child's head is at or below the top of the stroller seat.
- **ONLY** use this stroller with **ONE** child at a time.
- **STROLLER** mode is for use with children who can sit up unassisted and is **NOT** recommended for newborns.
- Failure to follow the steps and warnings on the labels and in the instruction manual can result in serious injury or death to your child.

Contents

Parts of Stroller.....	1	Attaching & Removing Canopy.....	12
Installing Wheels.....	2	Adjusting Canopy	12
Using Parking Brake.....	4	Adjusting Footrest.....	13
Removing Wheels	4	Attaching & Removing Child Tray	14
Modes of Use	5	Parent Tray & Storage Basket Use	15
Car Seat Carrier Mode	6	Securing Child in Stroller Seat.....	16
Removing Car Seat from Stroller Frame or Stroller Seat.....	6	Changing Stroller Seat Harness Strap Height	18
Stroller Seat Mode	7	Adjusting Harness System Length	19
Removing Stroller Seat from Stroller Frame	7	Folding Stroller	20
Carriage Mode	8	Unfolding Stroller	21
Travel System Mode	9	Wash & Care of Stroller Parts.....	22
Adjusting Stroller Seat Backrest.....	10	Dorel Juvenile Group Information	23
Adjusting Stroller Seat Positions.....	11	Replacement Parts.....	23
		Warranty	23

Parts of Stroller

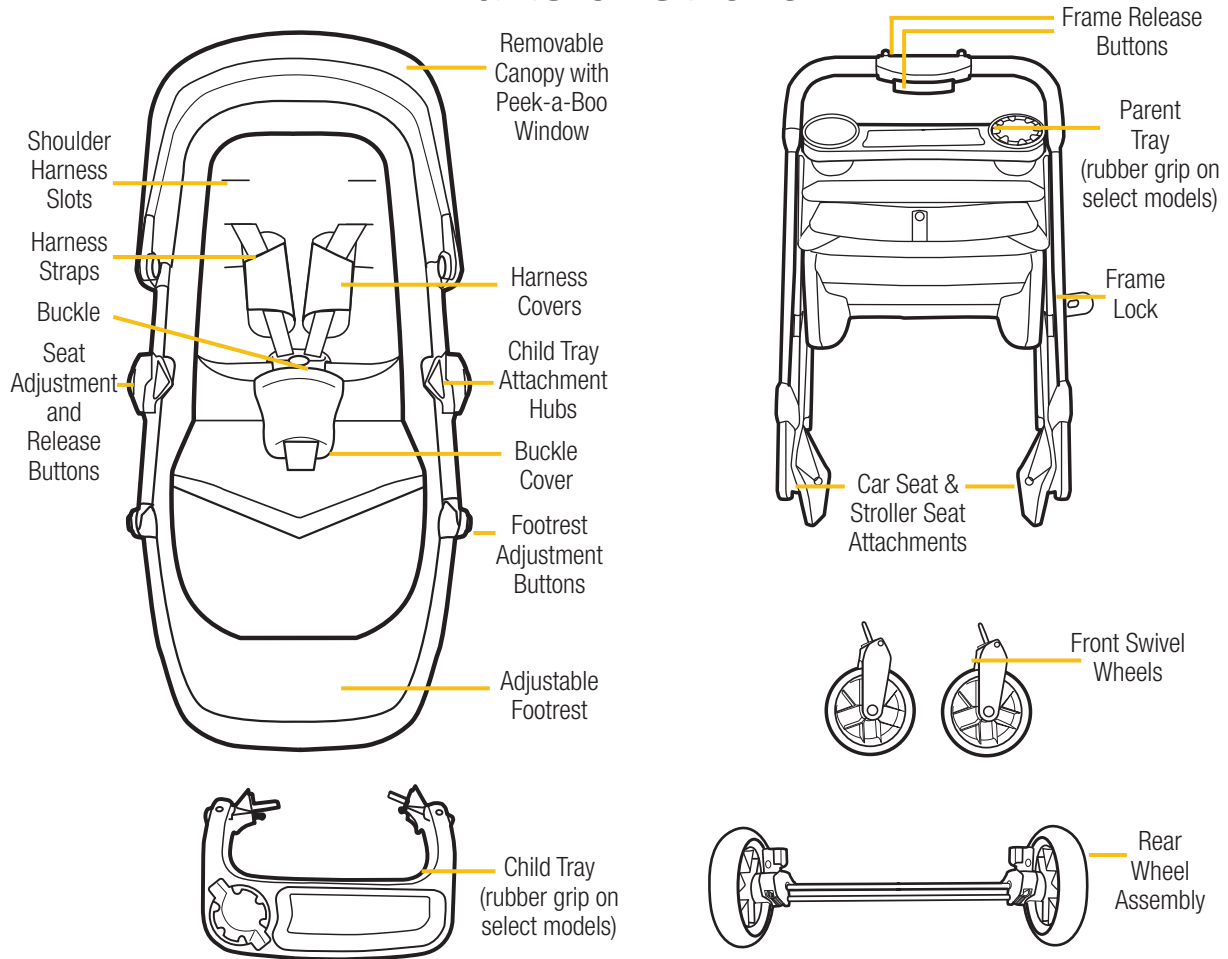

Lay out and identify all of the parts.

If any parts are missing, **do not return this product to the place of purchase.**

Please contact Consumer Care via:

- Phone: 1-800-544-1108
- Text: 1-812-652-2525
- Chat: www.safety1st.com

You will need to know the model number and manufacture date.

It is located on a label on the stroller frame.

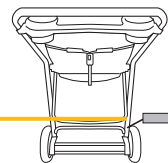

Installing Wheels

Front Swivel Wheels

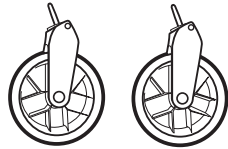

Rear Wheel Assembly



1

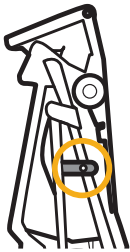

Unfasten frame lock.

2

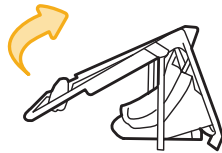

- Unfold the stroller until you hear it click and lock into fully the open position.
- Lay the stroller down on the floor as shown.

click!

3



Attach the front swivel wheels as shown.

WARNING:

ALWAYS keep fingers away from moving parts, when folding, unfolding, or adjusting stroller to prevent finger entrapment.

4

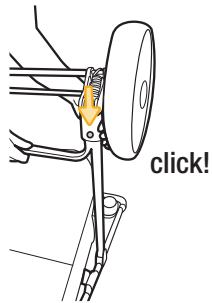
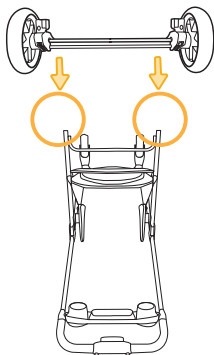

- Align the rear wheel assembly hubs with the rear leg posts on the stroller frame.
- The pin on the stroller frame will go into the slot in the wheel assembly hubs as shown.
- Then set the stroller upright.

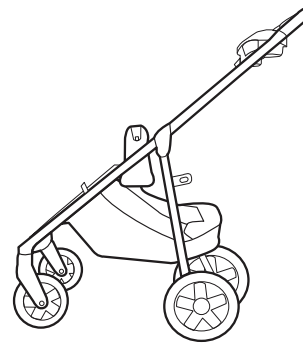

Finished!

NOTE: Pull down on the front wheels and rear wheel assembly to make sure they are attached securely.

To use parking brake, see page 4.

For Car Seat Carrier Mode, see page 6.

For Stroller Seat Mode, see page 7.

For Carriage Mode, see page 8.

For Travel System Mode, see page 9.

To fold and unfold stroller, see pages 20-21.

Using Parking Brake

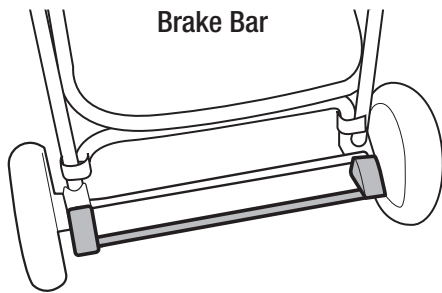

To Lock Parking Brake

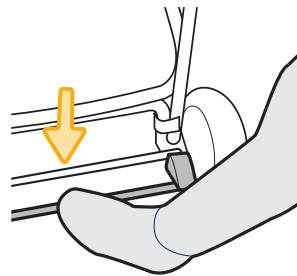

Step on the brake bar to lock.

To Release Parking Brake

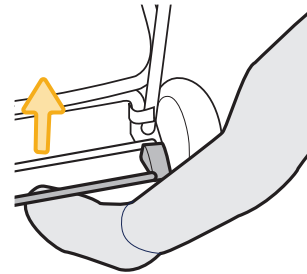

Pull the brake bar up to release.

Removing Wheels

Rear Wheel Assembly

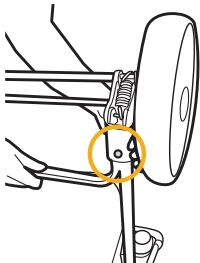

Turn stroller upside down.
Locate the rear wheel
release buttons.

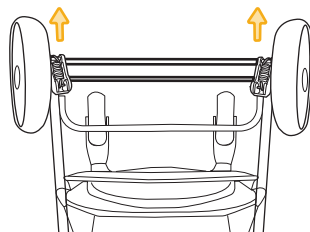

Press the release buttons while
pulling the rear wheel assembly
up and pull it away from the
stroller.

Front Swivel Wheels

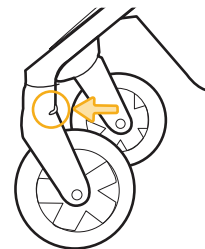

Locate the front wheel
release button.
Press the release button in while
pulling the front wheel down.
Repeat for other side.

Modes of Use

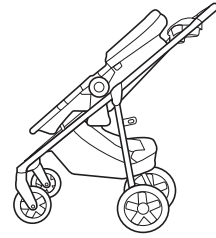
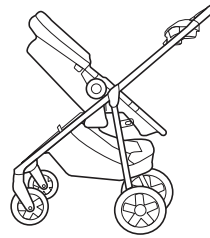

Car Seat Carrier Mode
See page 6.

Stroller Seat Mode
See page 7.

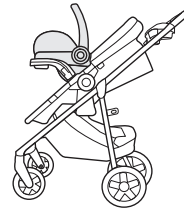
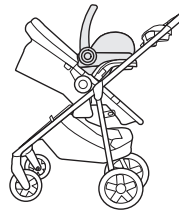
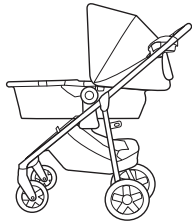
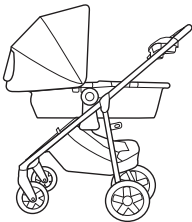

Carriage Mode
See page 8.

Travel System Mode
See page 9.

Car Seat Carrier Mode

1

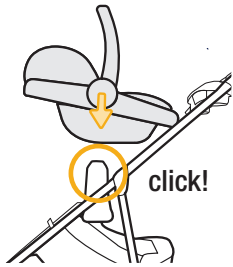

Attach the car seat rear-facing or forward-facing to the attachments on the stroller frame.

2

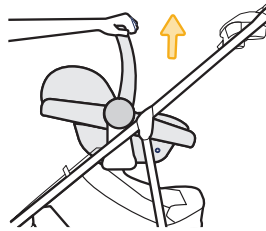

Pull the car seat up either at the carry handle or handle hubs to check if it is attached securely.

Car seat can be used rear-facing or forward-facing. See car seat instruction manual for how to secure your child in the car seat.

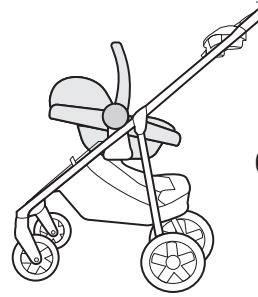

OR



Finished!

Removing Car Seat from Stroller Frame or Stroller Seat

Example shown of an onBoard Model's Stroller Release Handle



Car seat stroller release mechanisms & locations vary by car seat model.

Review your car seat's instruction manual to locate the stroller release mechanism on your car seat.

Illustrations show a generic car seat icon.

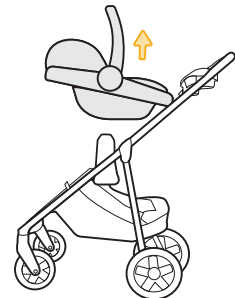
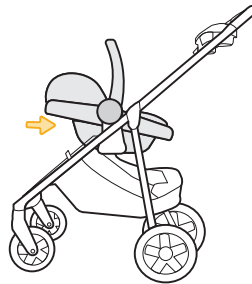

While engaging your car seat's stroller release mechanism, lift the car seat off of the stroller frame.

Stroller Seat Mode

Stroller seat can be used rear-facing or forward-facing.

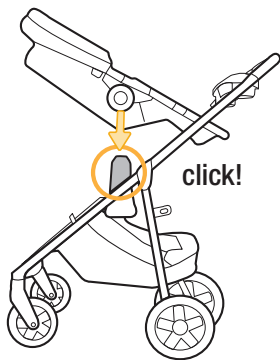

Attach the stroller seat rear-facing or forward-facing to the attachments on the stroller frame.

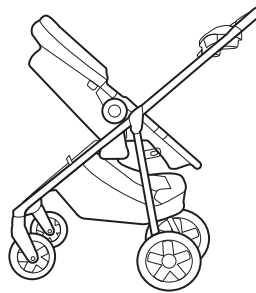

OR

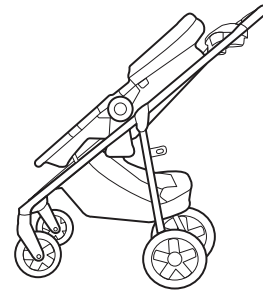

Finished!

To adjust the stroller seat backrest, see page 10.

To adjust positions of the stroller seat, see page 11.

To secure child in stroller seat, see page 16.

Removing Stroller Seat from Stroller Frame

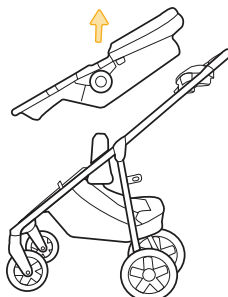
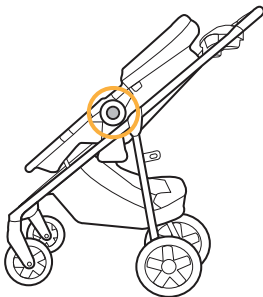

Press the release buttons on each side of the seat all the way in and lift the stroller seat up and off of the stroller frame.

Carriage Mode

Carriage mode can be used rear-facing or forward-facing.

1



Attach the stroller seat either rear-facing or forward-facing to the attachments on the stroller frame.

2

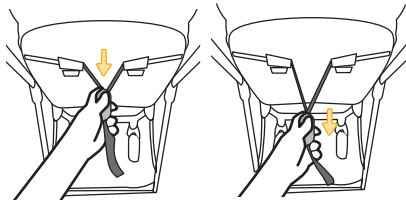

Fully recline the stroller seat backrest. At the back of the stroller seat, press the button on the backrest adjuster all the way and pull it towards you.

For more information about adjusting the backrest, see page 10.

3

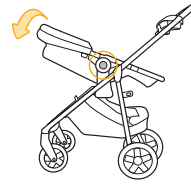

Push the seat stroller adjustment buttons and rotate the seat all the way back.

For more information about stroller seat positions, see page 11.

4

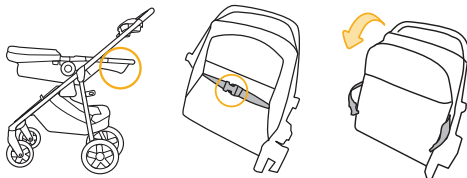

Locate the strap under the footrest. Undo the buckle on the strap as shown.

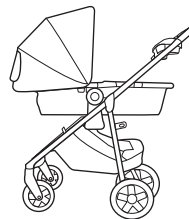

OR

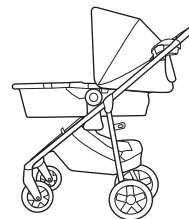

Finished!

WARNING:

Child may slip into leg openings and strangle, unless you disengage buckle under the foot rest and press down the foot area to create safe enclosure.

Travel System Mode

Stroller seat can be installed rear-facing or forward-facing.
Car seat **MUST ALWAYS** face the stroller seat when in travel system mode.
Child tray **MUST ALWAYS** be used in travel system mode.

1

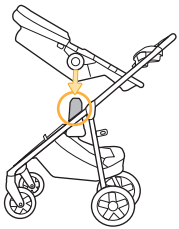

Install the stroller seat either rear-facing or forward-facing to the attachments on the stroller frame. You will hear each side “click” when it is locked into place.

2

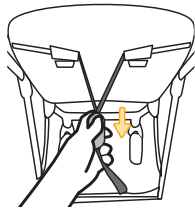

Fully recline the stroller seat backrest.
For more information about adjusting the backrest, see page 10.

3

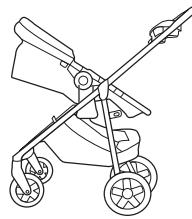

Fold the canopy back. Adjust the stroller seat to the most upright position.
For more information about stroller seat positions, see page 11.

4

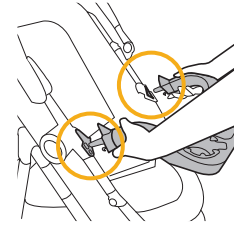

Attach the child tray.
For more information about the child tray, see page 14.

5

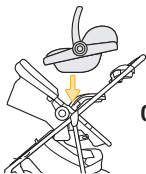

Install the car seat to the attachments on the stroller seat. You will hear each side “click” when it is secure.

6

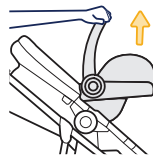

Pull the car seat up either at the carry handle or handle hubs to check if it is attached securely.

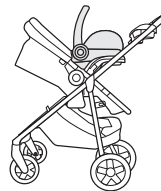

OR

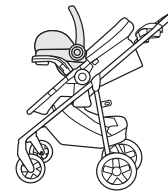

Finished!

To remove carseat from stroller seat, see page 6: Removing Car Seat from Stroller Frame or Stroller Seat.

Adjusting Stroller Seat Backrest

To Recline Backrest

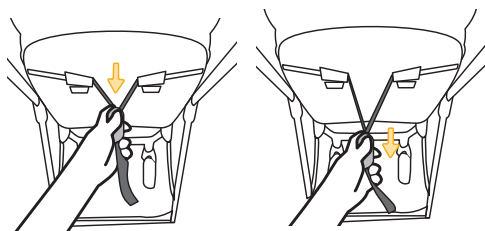

At the back of the stroller seat, slide and hold the button on the backrest adjuster and pull the adjuster away from the seat.

To Make Backrest Upright

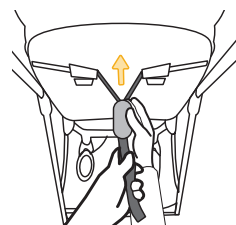

At the back of the stroller seat, hold the loose end of the strap and slide the backrest adjuster up the strap toward the back of the seat.

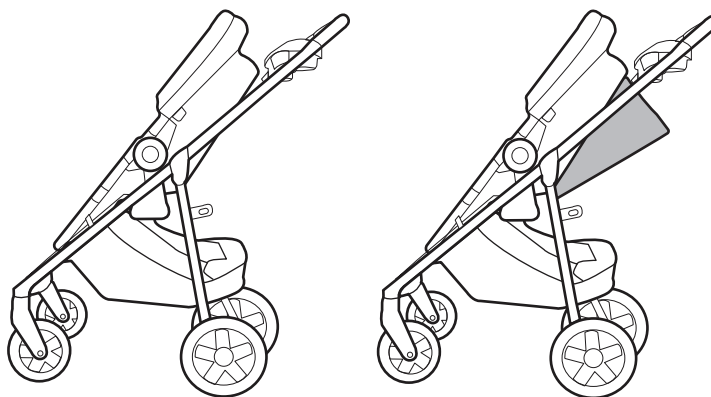

Illustrations show the stroller seat backrest upright and reclined; however there are multiple recline positions.

Adjusting Stroller Seat Positions

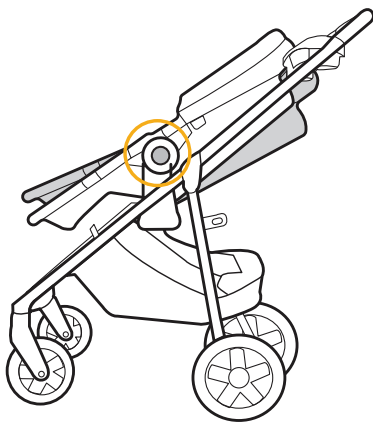

Locate the stroller seat adjustment buttons on each side of the stroller seat.

Press and hold in both of the adjustment buttons until you can rotate the seat backward or forward to the desired position.

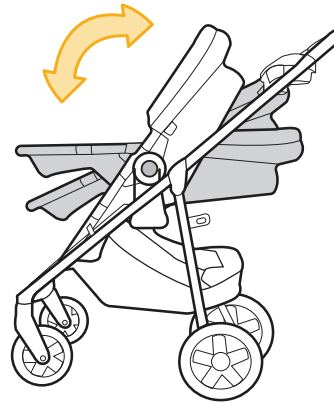

Forward-Facing

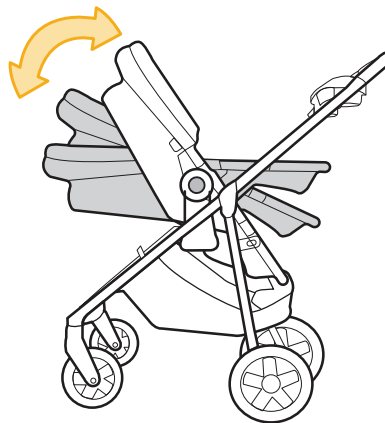

Rear-Facing

Attaching & Removing Canopy

To Attach Canopy

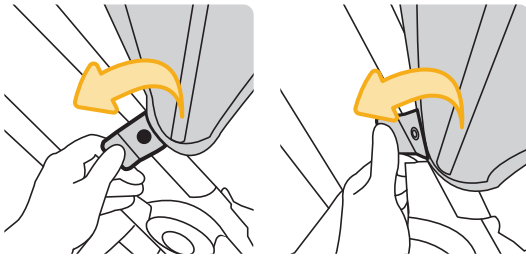

Align the canopy tabs with the attachment on the stroller frame and push the canopy tabs down to snap them to the stroller frame.

To Remove Canopy

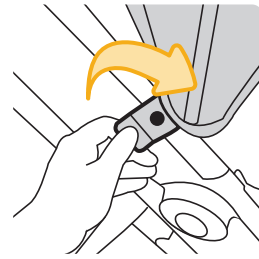

Locate the canopy tabs and pull them forward to remove the canopy from the stroller frame.

Adjusting Canopy

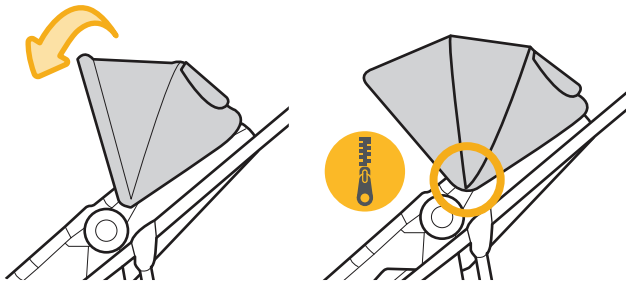

Pull the canopy forward.
On select models: Unzip the canopy to extend it farther.

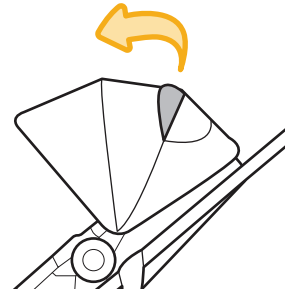

Lift the fabric to access the Peek-a-Boo window.

Adjusting Footrest

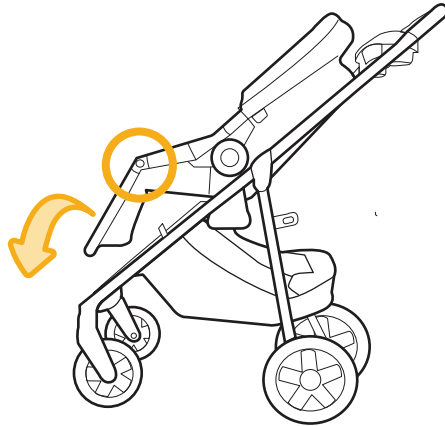

To lower footrest, press the footrest adjustment buttons and push down on the footrest.

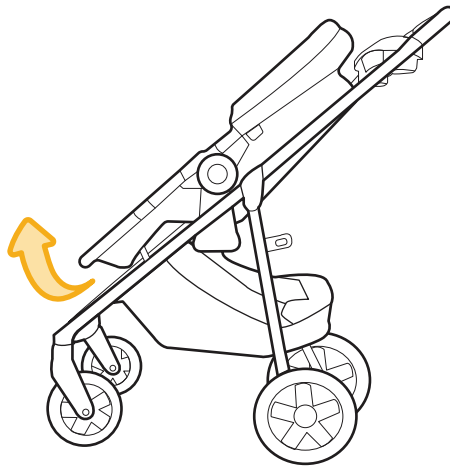

To raise footrest, pull the footrest up until it locks into place.

Attaching & Removing Child Tray

To Attach Child Tray

1

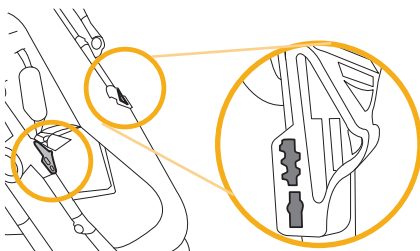

Locate the child tray attachment hubs on each side of the stroller frame.

2

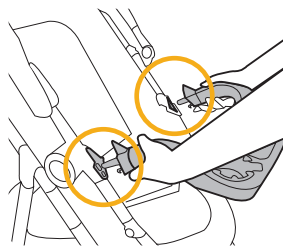

Align the posts on the child tray with the slots in the attachment hubs.

3

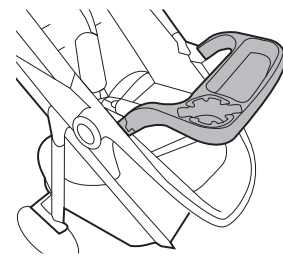

Gently pull out on tray to make sure it is attached securely.

The child tray can also swivel open to make it easier to put in or remove your child.

To Swivel Open

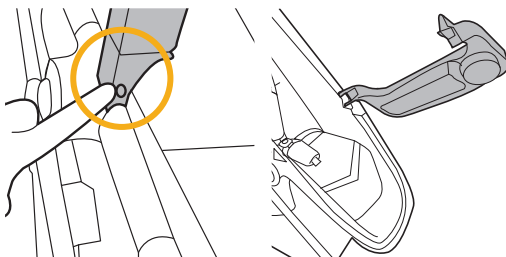

Locate one of the buttons underneath each side of child tray.

Press one button and push the child tray to the side of the stroller frame.

To Remove Child Tray

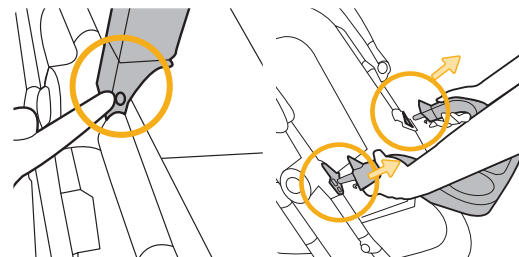

Locate the buttons underneath each side of child tray.

Press both buttons and pull the child tray away from the stroller frame.

Parent Tray & Storage Basket Use

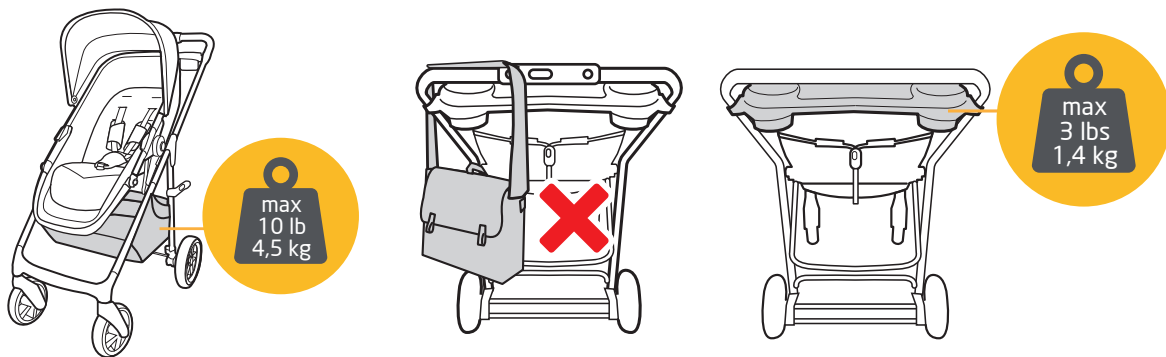

⚠ WARNING:

- **NEVER** place more than 10 lb (4.5 kg) in the storage basket. If weight is exceeded, hazardous unstable conditions may exist.
- Parent tray, including the cup holders, **CANNOT** exceed 3 lbs (1.4 kg) total.

Securing Child in Stroller Seat

1

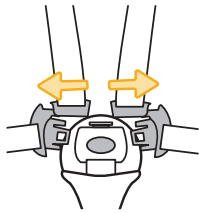

Unbuckle.

2



Place your child in the stroller seat.

3

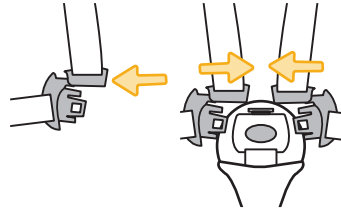

Align the buckle tongue with the tab on top of the buckle. Slide into place.

Repeat for the other side.

4

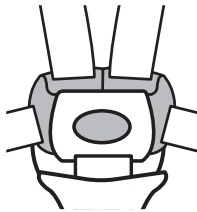

Buckle.

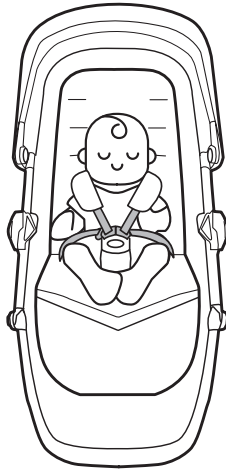

Finished!

WARNING:

- **NEVER LEAVE CHILD UNATTENDED.** **ALWAYS** keep child in view when in stroller.
- **AVOID SERIOUS INJURY** from falling or sliding out. **ALWAYS** use the harness system. Check frequently to make sure it is secure.
- **STROLLER** is only for use with children up to 50 lb (22.7 kg), and **WHEN SEATED**, the midpoint of your child's head is at or below the top of the stroller seat.
- **ONLY** use this stroller with **ONE** child at a time.
- **STROLLER MODE** is for use with children who can sit up unassisted and is **NOT** recommended for newborns.
- Failure to follow these instructions could result in serious injury or death of your child.

Changing Stroller Seat Harness Strap Height

As your child grows, you will need to adjust the harness strap height.

Harness System

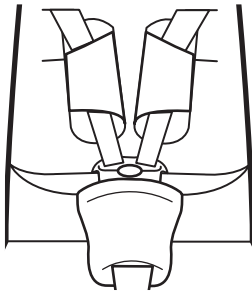

1

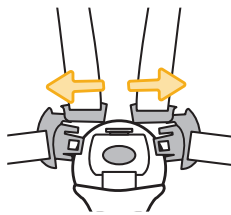

Unbuckle.

2

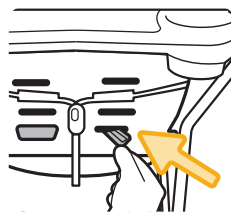

From the back of the stroller seat, push the harness strap retainers through the harness slots.

3

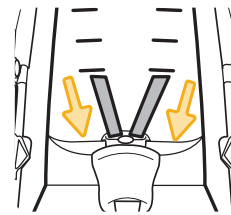

From the front of the stroller seat, pull the harness straps out of the harness slots.

4

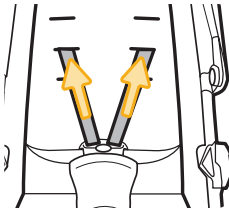

Push the the harness straps into the harness slots closest to your child's shoulders.

5

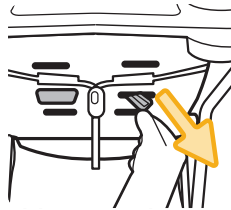

Pull the harness strap retainers through the harness slots.

WARNING:

- Belts must be threaded exactly as shown.
- Failure to follow these instructions could result in serious injury or death of your child.

Adjusting Harness System Length

To Adjust Harness Strap

To Shorten

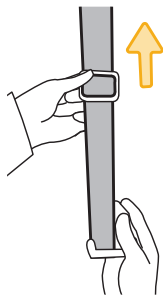

Hold the slide ring in one hand and hold the buckle clip in the other. Slide the ring up.

To Lengthen

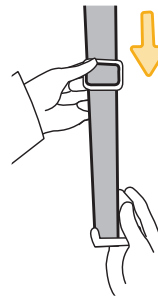

Hold the slide ring in one hand and hold the buckle clip in other. Slide the ring down.

To Adjust Waist Strap

To Shorten

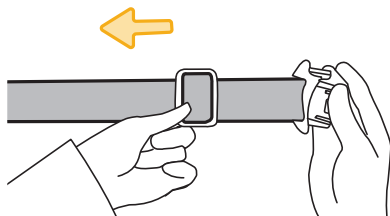

Hold the slide ring in one hand and hold the buckle clip in the other. Slide the ring away from the buckle clip.

To Lengthen

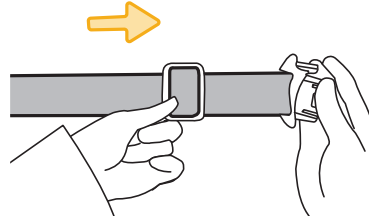

Hold the slide ring in one hand and hold the buckle clip in the other. Slide the ring towards the buckle clip.

Folding Stroller

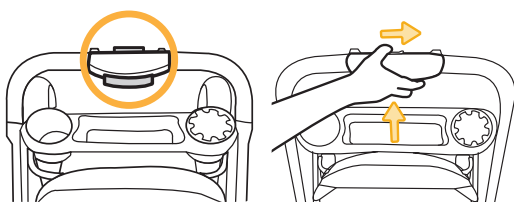

Slide and squeeze the stroller frame release buttons as shown.
Hold them together.



Fold the stroller down as shown.

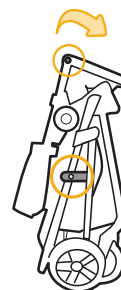

Fasten the frame lock.
Optional: Fold the footrest down.

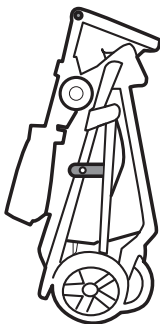

Finished!

NOTE: The stroller can self stand.

WARNING:

ALWAYS keep fingers away from moving parts, when folding, unfolding, or adjusting stroller to prevent finger entrapment.

Unfolding Stroller

1

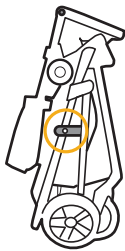

Unfasten the frame lock.

2

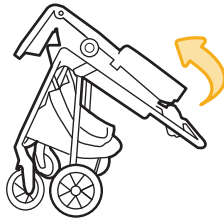

Fold the stroller out as shown.

You will hear both sides click when it is fully locked open.

3

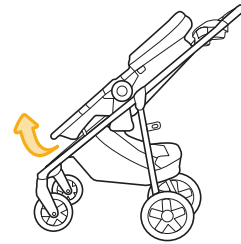

Adjust the footrest to desired position.

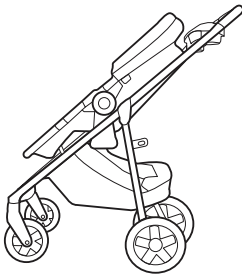

Finished!

WARNING:

ALWAYS keep fingers away from moving parts, when folding, unfolding, or adjusting stroller to prevent finger entrapment.

Wash & Care of Stroller Parts

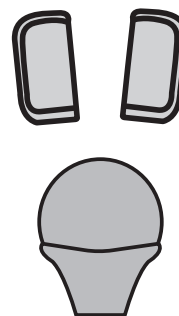
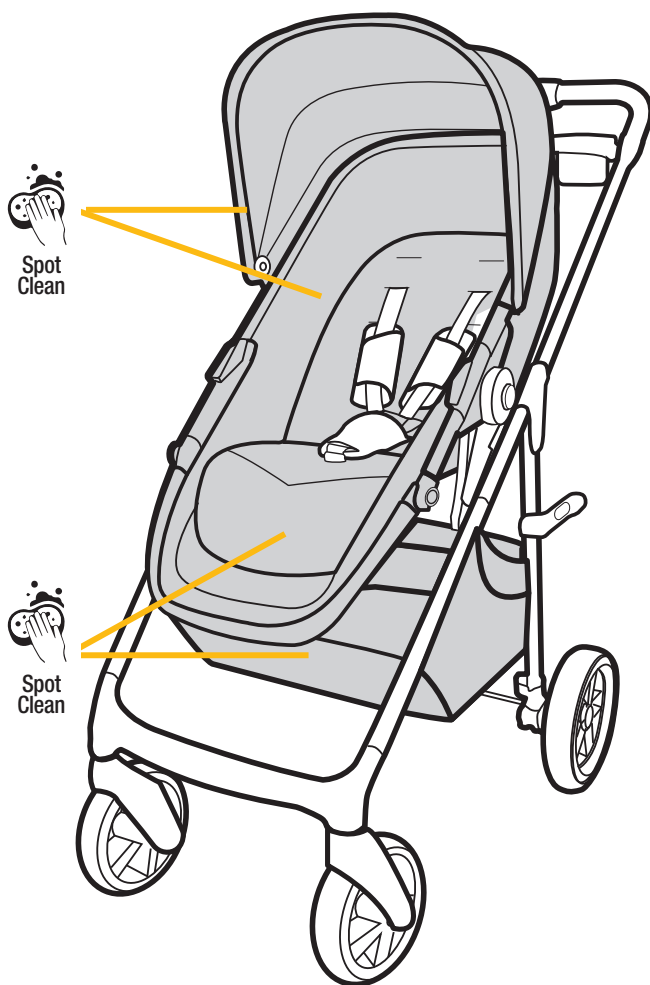

Cleaning Harness Covers & Buckle Cover

- Machine wash separately with cold water on a gentle cycle.
- Do not use bleach.
- Tumble dry separately for 10-12 minutes on low heat.
- Remove immediately.

Dorel Juvenile Group Information

Thank you for choosing this stroller.

The DJG family is committed to creating strollers with the most comfort and convenience available today.

If you have questions or any concerns with this stroller, please contact our Consumer Care Department.

For parts availability and questions, please contact us via phone, text, or chat.

Include the model number and manufacture date (found on a sticker on the stroller frame) and a brief description of the part.

- Rear Wheel Assembly
- Front Swivel Wheels (2)
- Harness Covers (2)
- Child Tray
- Buckle Cover



Call: 1-800-544-1108



Text: 1-812-652-2525



Chat: www.safety1st.com

Hours of Operation:

M-TH: 8:00 AM - 6:00 PM EST

FRI: 8:00 AM - 4:30 PM EST

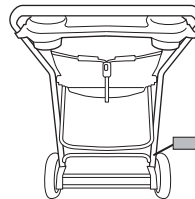

**Date of
Manufacture Label**

Two-Year Limited Warranty

Dorel Juvenile Group, Inc. warrants to the original purchaser that this product (Grow and Go 8-in-1 Stroller), is free from material and workmanship defects when used under normal conditions for a period of two (2) years from the date of purchase. Should the product contain defects in material or workmanship Dorel Juvenile Group, Inc., will repair or replace the product, at our option, free of charge. Purchaser will be responsible for all costs associated with packaging and shipping the product to Dorel Juvenile Group Consumer Care Department at the address noted on the back of this document and all other freight or insurance costs associated with the return. Dorel Juvenile Group will bear the cost of shipping the repaired or replaced product to the purchaser. Product should be returned in its original package accompanied by a proof of purchase, either a sales receipt or other proof that the product is within the warranty period. This warranty is void if the owner repairs or modifies the product or the product has been damaged as a result of misuse. This warranty excludes any liability other than that expressly stated previously, including but not limited to, any incidental or consequential damages. SOME STATES DO NOT ALLOW THE EXCLUSION OR LIMITATION OF INCIDENTAL OR CONSEQUENTIAL DAMAGES, SO THE ABOVE LIMITATION OR EXCLUSION MAY NOT APPLY TO YOU. THIS WARRANTY GIVES YOU SPECIFIC LEGAL RIGHTS, AND YOU MAY ALSO HAVE OTHER RIGHTS THAT MAY VARY FROM STATE TO STATE.



Grow and Go™

8-in-1 Stroller

Max 50 lb (22.7 kg)

©2021 Dorel Juvenile Group, Inc. (800) 544-1108 www.safety1st.com. Styles and colors may vary. Los estilos y los colores pueden variar. Les styles et les couleurs peuvent varier. Made in CHINA. Fabriqué en CHINE. Hecho en CHINA. Distributed by (distribuido por) (distribuí por) Dorel Juvenile Group, Inc., 2525 State St., Columbus, IN 47201-7494. Dorel Juvenile Canada, 2233 Argentia Road, Suite 110, Mississauga, ON L5N 2X7. Importado y Distribuido en Chile por: Comercial e Industrial Silfa S.A. - San Ignacio 0201 / Parque Industrial Portezuelo Quilicura, Santiago Chile. Fono (562) 2339 9000. En Perú por: Comexa S.A. - Los Libertadores 455 - San Isidro, Lima - Perú. Fono (511) 4469014. En Centro América, Caribe y Ecuador por: Best Brands Group S.A. - Av. Balboa, Bay Mall Plaza, Planta Baja, local 9, Panamá. - Fono: (507) 300 2884. En Colombia por: Baby Universe S.A.S. - Vía 40 No. 77-29, Barranquilla, Colombia - Fono: (575) 353 1110 Importador: DJGM, S.A. DE C.V. Gabriel Mancera No. 1041 Col. Del Valle, Benito Juárez C.P. 03100 México, Ciudad de México R.F.C. DJG140305GN9 Tel. (55) 67199202 8/21 4358-8199

