

REBEL 54 INCH FOOSBALL TABLE

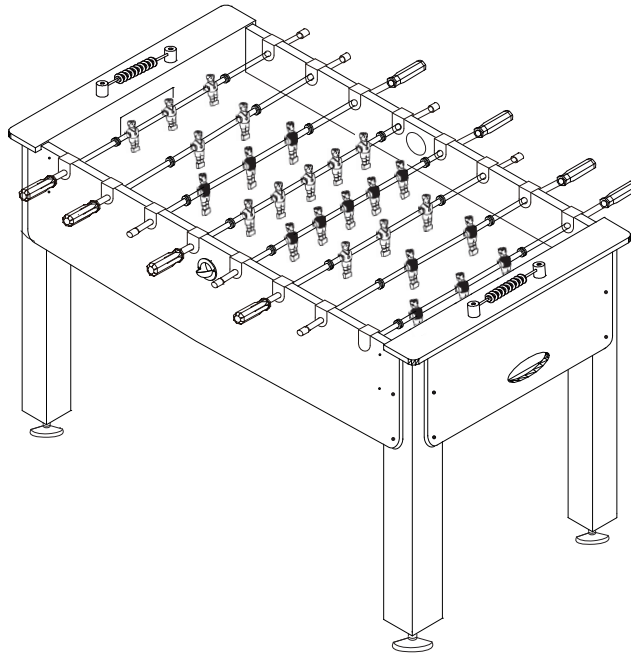

Replacement Parts

Order direct at www.gldproducts.com
or call our Customer Service department at
(800) 225-7593
8 am to 4:30 pm Central Standard Time

GLD Products

Rebel Foosball Table

Item 64-0913

Staple your receipt here.

Important: A copy of your receipt will be needed to activate your warranty (see page 16).



Congratulations and THANK YOU for purchasing the Rebel 54 Inch Foosball Table. You have chosen a product that should provide years of entertainment. To assist you with customer service and warranty claims, staple your receipt to the inside cover, then keep this manual in a safe place for future reference.

GLD Products

S84 W19093 Enterprise Drive
Muskego, WI 53150 USA
1-800-225-7593
Fax: 1-800-841-6944
Email: gld@gldmfg.com
Web: www.gldproducts.com

This manual may have been updated. For the latest manual visit the GLD products website.

	<p>Place your package near the location where it will be used. Carefully unpack all components and verify you have all the correct pieces.</p> <p>If you notice missing or defective parts, please call us at: 1-800-225-7593</p>
---	--









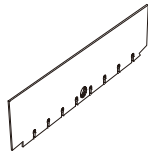
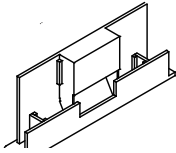
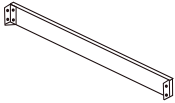
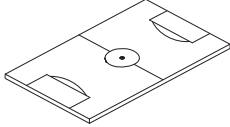
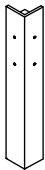

	<p>Please read and understand all instructions before beginning assembly.</p> <p>This assembly will require 2 adults.</p> <p>This product is not for use by children without adult supervision.</p>
---	--

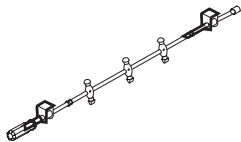
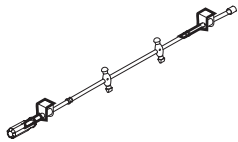
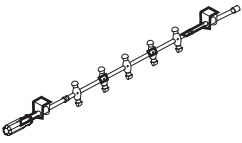
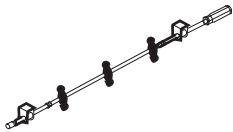

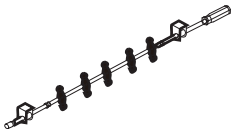
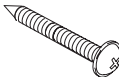



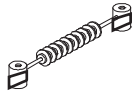
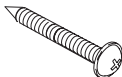

GLD Products

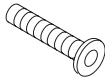
Rebel Foosball Table

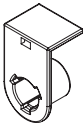
Parts Identifier

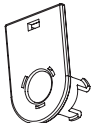
Item 64-0913

Part No./ Qty	Illustration/ Order Number	Part No./ Qty	Illustration/ Order Number	Part No./ Qty	Illustration/ Order Number
1 Qty 2	 Side Apron Order No. 3-347	2 Qty 2	 End Apron Order No. 3-348	3 Qty 2	 Support Brace Order No. 3-349
4 Qty 1	 Playfield Order No. 3-350	5 Qty 4	 Leg Order No. 3-351	6 Qty 2	 Ball Entry Cup Order No. 3-324
7 Qty 4	 Leg Base Order No. 3-352	8 Qty 2	 3 Player Rod-Ivory	9 Qty 1	 2 Player Rod-Ivory
10 Qty 1	 5 Player Rod-Ivory	11 Qty 2	 3 Player Rod-Red	12 Qty 1	 2 Player Rod-Red
13 Qty 1	 5 Player Rod-Red	14 Qty 16	 3.5 x 35 mm Screw Order No. 3-332	15 Qty 4	 3.5 x 18 mm Screw Order No. 3-329
16 Qty 4	 3.5 x 12 mm Screw Order No. 3-330	17 Qty 2	 Soccer Ball Order No. 27-0209	18 Qty 2	 Scorers Order No. 3-331
19 Qty 8	 4 x 40 mm Screw Order No. 3-353	20 Qty 8	 3.5 x 12 mm Screw Order No. 3-334	21 Qty 1	 Allen Key Order No. 1-288

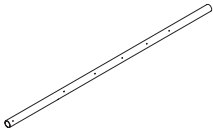
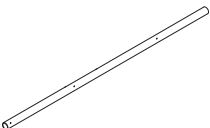
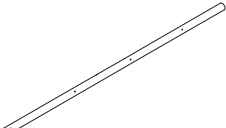
Part No./ Qty	Illustration/ Order Number	Part No./ Qty	Illustration/ Order Number	Part No./ Qty	Illustration/ Order Number
22 Qty 16	 M8 x 28 mm Bolt Order No. 3-335	23 Qty 16	 M8 Washer Order No. 3-336	24 Qty 4	 Plastic Bracket (Pre Installed) Order No. 3-328
25 Qty 16	 Bushing - Outside (Pre Installed) Order No. 3-345	26 Qty 16	 Bumper (Pre Installed) Order No. 3-340	27 Qty 16	 Rod Washer (Pre Installed) Order No. 3-341
28 Qty 16	 Bushing - Inside (Pre Installed) Order No. 3-346	29 Qty 13	 Player - Red (Pre Installed) Order No. 3-354	30 Qty 13	 Player - Ivory (Pre Installed) Order No. 3-355
31 Qty 8	 Grip - Molded (Pre Installed) Order No. 3-338	32 Qty 8	 Rod End Cap (Pre Installed) Order No. 3-339	33 Qty 2	 5 Player Rod Only (Pre Installed) Order No. 3-327
34 Qty 2	 2 Player Rod Only (Pre Installed) Order No. 3-326	35 Qty 4	 3 Player Rod Only (Pre Installed) Order No. 3-325		

IF YOU HAVE A WARRANTY CLAIM, CALL US FIRST:

Please refer to page 16.

GLD Products

Available 8 am to 4:30 pm Central Standard Time

S84 W19093 Enterprise Drive

Muskego, WI 53150 USA

1-800-225-7593

Fax: 1-800-841-6944

Email: gld@gldmfg.com

Web: www.gldproducts.com

For all claims, please have your receipt and item number when you call. The product item number can be found on the front cover.

If you are instructed to return the product for service, you are responsible for shipping the unit at your expense.

PRODUCT REGISTRATION

Important: The product registration form on page 17 and a copy of your receipt must be completed and returned within 10 days of purchase to validate your warranty.

Go to <http://gldproducts.com/warranty-information> or click on this link. Follow the online instructions.

Preparing for Assembly

- Be sure to unpack all of the parts included in this package. Some parts may be in obscure locations of the packaging. Check inside any tubes or sleeves. Save all packing material until the product is fully assembled and functional.
- Compare the parts in your package with the Parts Identifier description on pages 4 and 5.
- After unpacking large products, some disassembly may be required prior to beginning the assembly.

Tools Required

- Allen wrench (#23) - Included with table
- Phillips screwdriver - Not included with table
- Level - Not included

	CAUTION: Electric screwdriver may be helpful. You must set at LOW TORQUE and use extreme caution because you could overtighten the hardware, strip the screws, or damage the table.
---	--

Assembly Tips

Make sure you understand the following before you begin to assemble your foosball table.

1. READ THIS MANUAL all the way through before beginning assembly.
2. When installing parts that have more than one bolt, start ALL bolts in that part by hand before tightening anything.
3. Some drawings or images in this manual may not look exactly like your product.
4. You will need a second adult to assist with this assembly.

Note: Save all packing materials until the parts have been inspected and the table is assembled.

Unpack the Pieces

- Lay the box on a flat surface (floor). You may want this near your area of assembly.
- Unpack the boxes and part bags. Inspect and count the parts. The Parts Identifier page can be used to record your results.
- If any parts are damaged or missing contact GLD customer service.
- Missing fasteners may be purchased at a hardware store using the descriptions on the Parts Identifier page(s).

STEPS FOR ASSEMBLING TABLE BASE

1. Place side apron (#1) with the color graphics facing outward and the top edge facing down.
2. Attach one goal end apron (#2) to the side apron (#1) using two screws (#19). Tighten the screws.
3. Now slide the second side apron (#1) into position. The color graphics of the side apron must face outward. The slots for the player rods on both side aprons (#1) must be down.
4. Use two screws (#19) to secure the side apron (#1) to the end apron (#2). Tighten the screws.
5. Slide the playfield (#4) onto the shoulders of the two side aprons (#1). The graphics should face down.

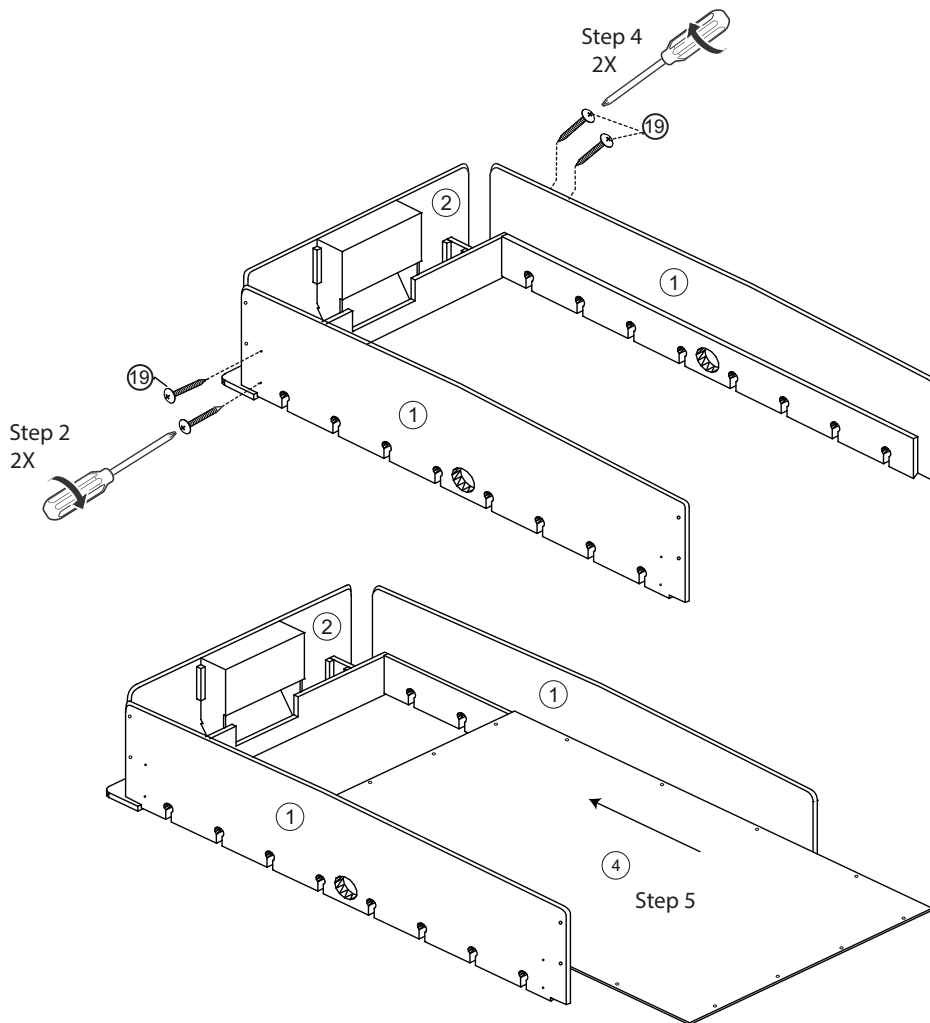

6. Attach the second goal end apron (#2) to the side aprons (#1) using two screws (#19) on each side.

Note: Be sure that the two side aprons (#1) and the end aprons (#2) are square.

7. Secure the playfield (#4) to the goal end aprons (#2) and the side aprons (#1) using 16 washer head screws (#14) in the pre-drilled holes.

CAUTION: The 16 screws (#14) are installed close to the side aprons. The use of a power screwdriver is likely to install the screws on an angle. To prevent damage, use a long shaft phillips screwdriver.

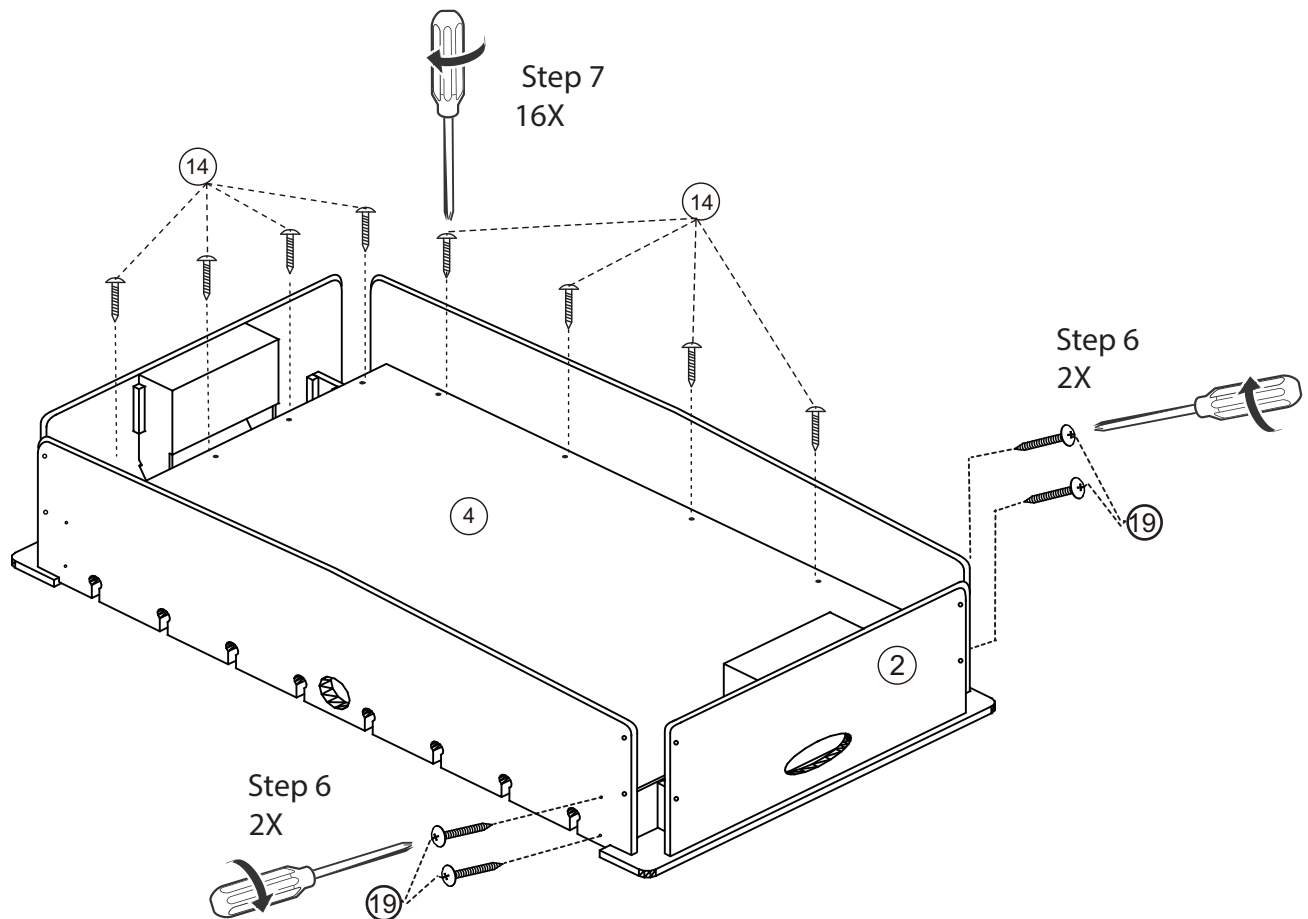

8. Place two support braces (#3) on the playfield (#4). Attach them by screwing in two washer head screws (#20) on each side of the table.

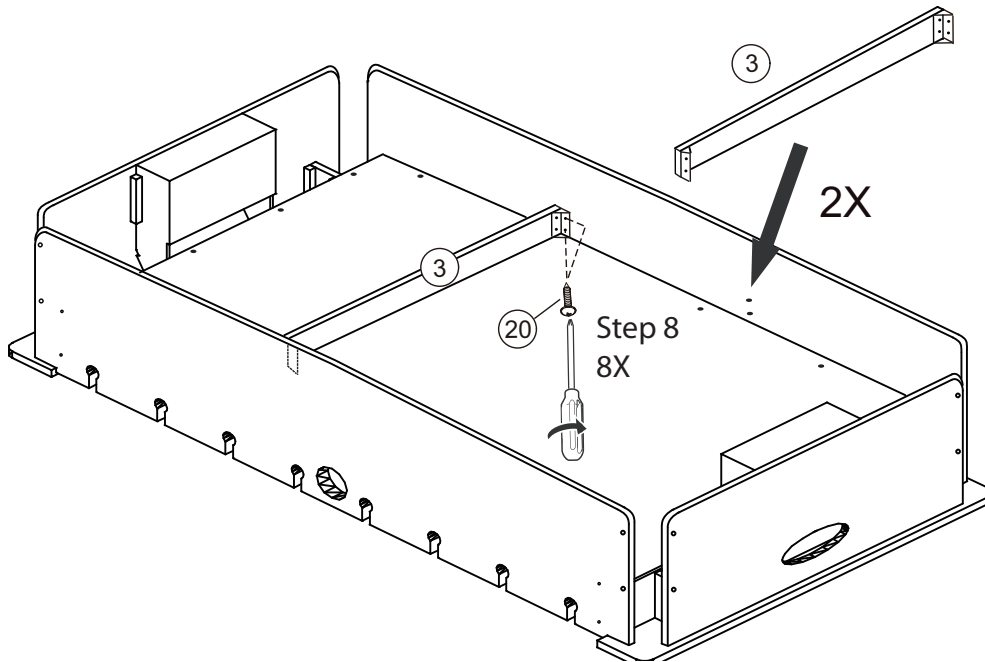

STEPS FOR ATTACHING THE LEGS

1. Locate the legs (#5). Place the legs (#5) into position on the inside corners of the side apron (#1) and the end apron (#2).
2. Use four bolts (#22) with washers (#23) and finger start one through each hole in the aprons.
3. Tighten the four bolts (#24).
4. Repeat steps 2 and 3 for the other three legs.

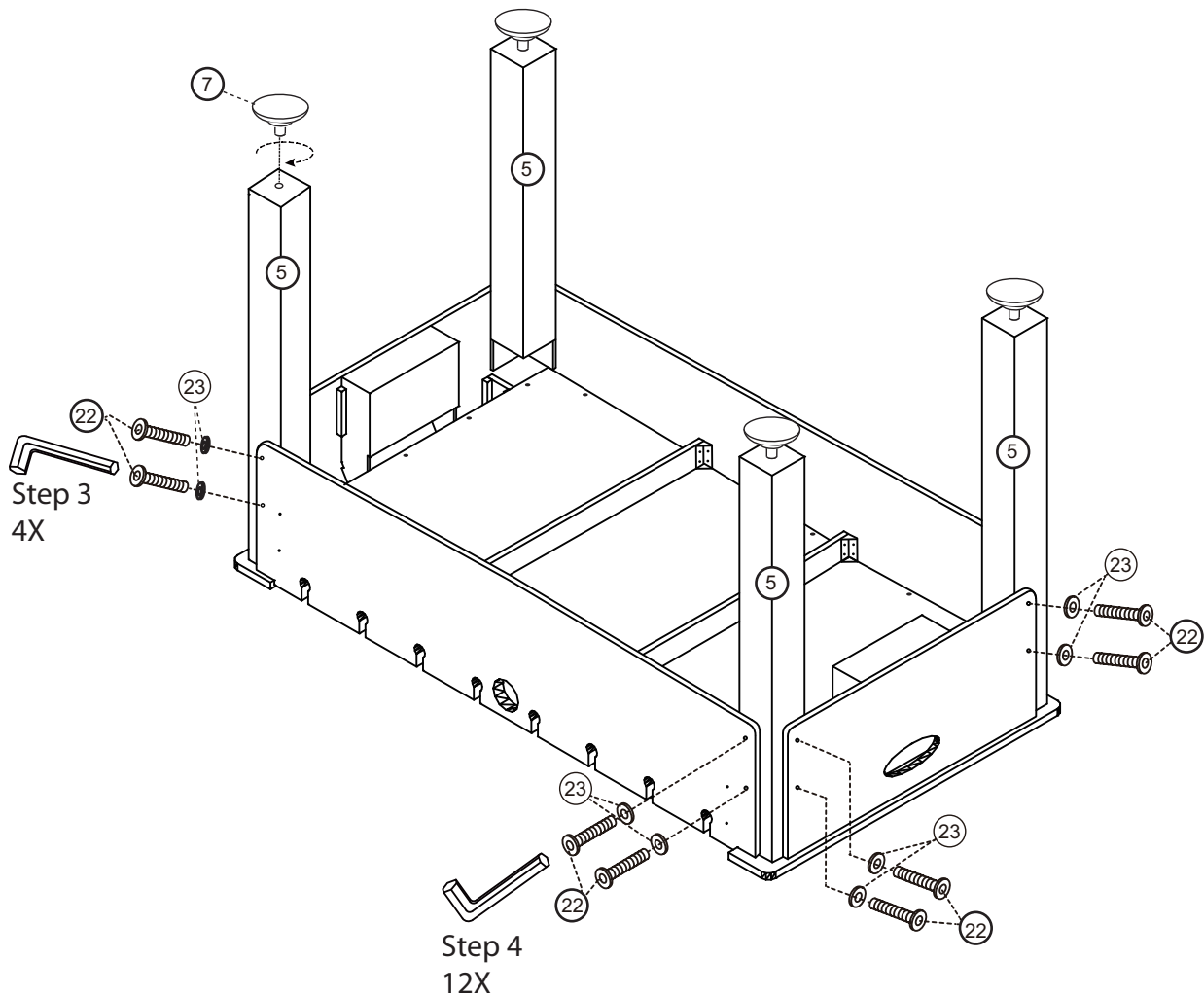

TO TURN BASE OVER

The base assembly is ready to be turned over.

USE AT LEAST TWO PEOPLE TO LIFT THE BASE ASSEMBLY AND TURN IT OVER TO REST ON THE LEGS.

DO NOT ROLL THE TABLE OVER. This will place a sideways force on the legs. The legs should be off the floor until the base assembly is rotated completely. Set the base assembly down.

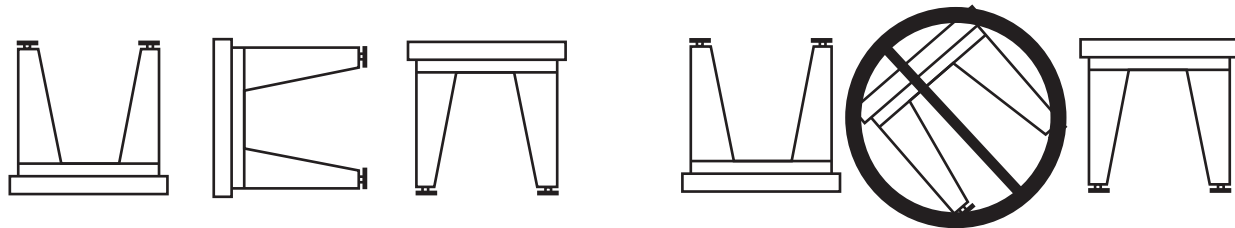

STEPS TO FINISH ASSEMBLY

Note: The player rods are pre assembled. The installer only needs to locate the correct position and direction. The rods are then snapped into position

1. Use the illustration to position each correct player rod into the proper slot.

Note: The handles for each color team will be on the same side.

Note: The player rod should spin freely.

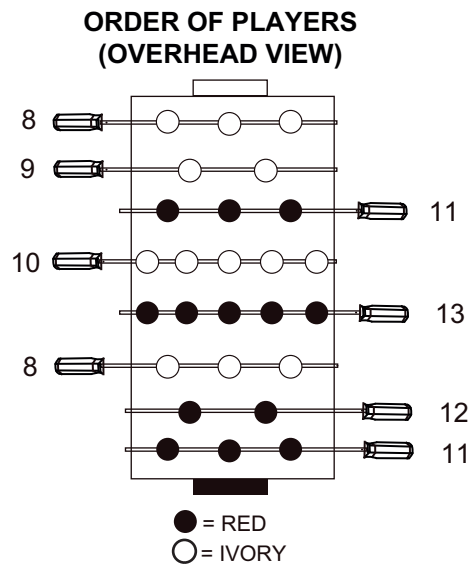

2. There are two bushings (#25 and #28) on each end of a player rod. These pieces must be on opposite sides of the side aprons (#1) when the player rod is dropped into position.
3. At one end of a player rod, move the two bushings (#25 and #28) together with the side apron (#1) between them.

Note: One bushing (#28) has a flat insert that will snap into a slot at the top of the other bushing (#25).

4. Snap the two bushings together to hold the player rod into the side apron (#1).
5. Repeat for all the remaining player rod bushings.
6. Position the two slide scorers (#18) above the goals. Use two screws (#15) in each one to secure it to the table.
7. Place a ball entry cup (#6) into the hole on one of the side boards (#1). Use two screws (#16) to hold it in place. Repeat for the other side.

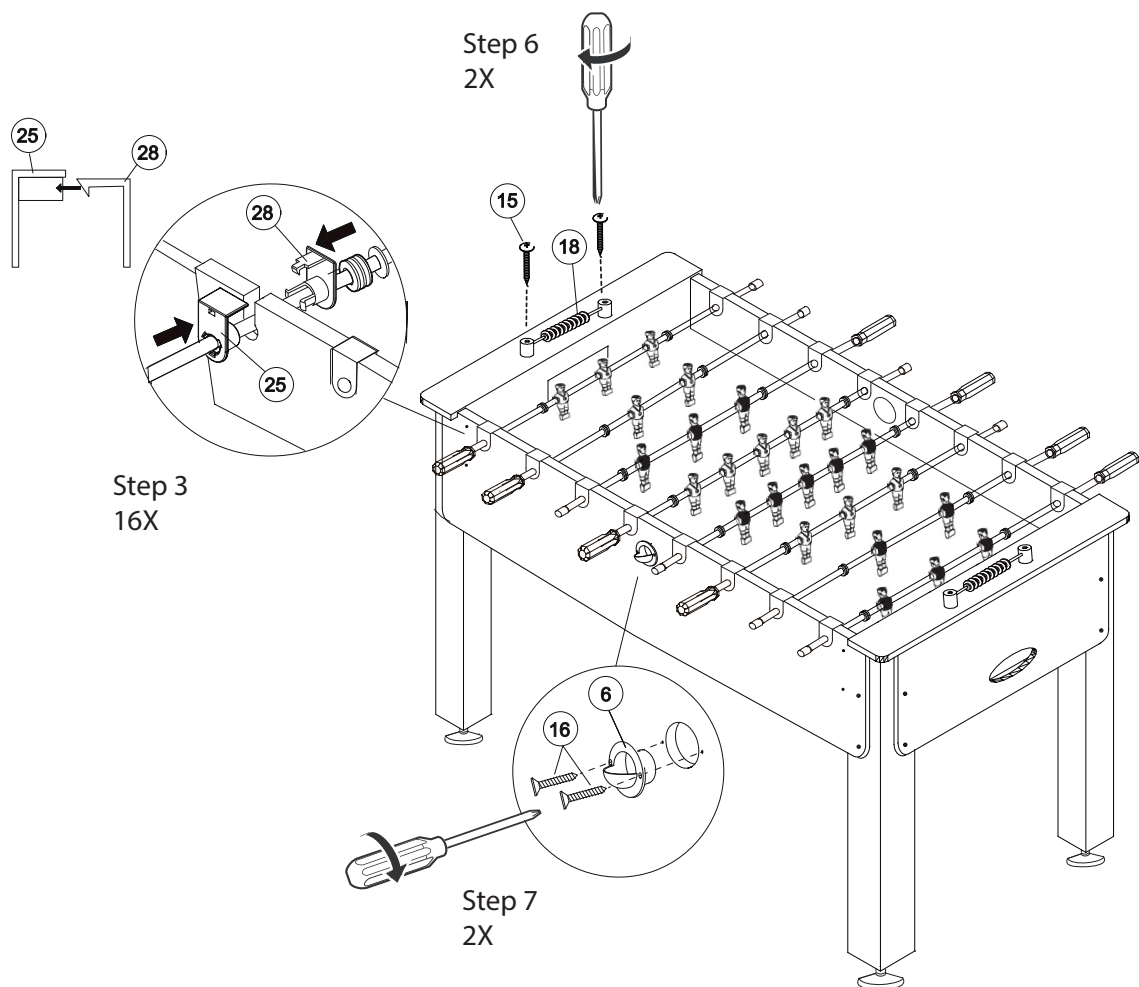

STEPS TO LEVEL THE TABLE

Use a carpenters level to adjust the leg levelers (#7) on the legs as needed until the table is level. Only basic leveling is needed as this is a fast game and the ball is always moving.

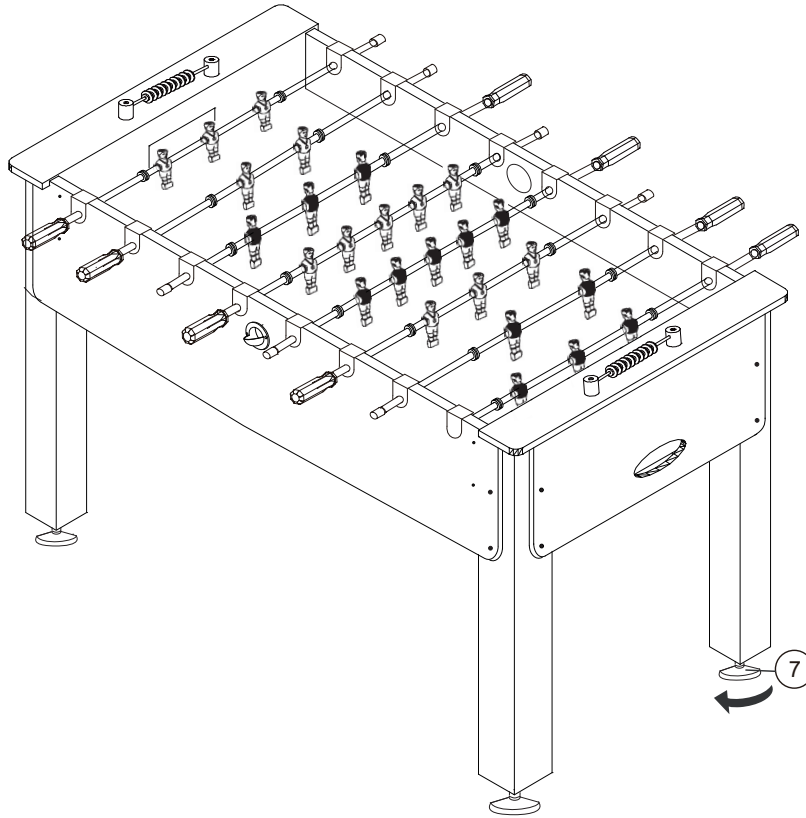

CARE AND USE OF YOUR TABLE

- This product is intended for INDOOR use only.
- DO NOT sit, climb, or lean on the table.
- DO NOT drag the table when moving it. This will damage the legs.
- To clean the hard surfaces spray a cloth with a mild cleaner and wipe.

90-DAY LIMITED WARRANTY

The Manufacturer warrants to the original retail purchaser that this product is free from defects in material and workmanship under normal use and conditions for a period of ninety (90) days from the date of original purchase. The Manufacturer's liability is limited to the repair or replacement, at its option, of any defective product and shall not include any liability for indirect, incidental or consequential damages of any kind.

Should this product become defective due to material or workmanship within the warranty period, contact our Customer Service Department. This warranty is not transferable and does not cover normal wear and tear or damage caused by improper usage, negligence, misuse, abuse, transportation damage, acts of nature, or accident (including failure to follow the instructions in this manual). It does not cover expendable items such as batteries, light bulbs, fuses, accessories, cosmetic parts and other items that wear out due to normal usage, including felt covered areas of the playing surface. This warranty is also void if the product is disassembled and reassembled, damaged, modified from its original state, or used for other than indoor personal residential use (no commercial or rental applications). This warranty gives you specific legal rights, and you may have other rights which vary from state to state.

IF YOU HAVE A WARRANTY CLAIM, CALL US FIRST (8 - 4:30 CST):

Please have your receipt and item number (found on the front cover) when you call.

GLD Products

S84 W19093 Enterprise Drive

Muskego, WI 53150 USA

1-800-225-7593

Fax: 1-800-841-6944

Email: gld@gldmfg.com

Web: www.gldproducts.com

If you are instructed to return the product for service, you are responsible for shipping the unit at your expense to the above address in packaging that will protect against further damage. All warranty or repair requests require a Return Authorization Number prior to returning the item.

PRODUCT REGISTRATION

Important: The product registration form on page 17 must be completed and returned along with a copy of your receipt within 10 days of purchase to validate your warranty.

On-line registration is also available. Go to <http://gldproducts.com/warranty-information> or click on this link. Follow the online instructions.

REGISTER YOUR PRODUCT

Place postage here

Complete this form, include a copy of your receipt, fold, tape (do not staple) and return within 10 days of purchase. This protects your warranty and will help us develop new products!

Cut here.

GLD Products
Warranty Department
S84 W19093 Enterprise Drive
Muskego, WI 53150 USA

Fold here second.



www.gldproducts.com

- | | |
|-----------------------|----------------------------|
| GAME TABLES | HOME CASINO |
| GAMES AND ACCESSORIES | BILLIARD CUES |
| BILLIARD ACCESSORIES | DARTBOARDS |
| SOFT-TIP DARTS | STEEL-TIP DARTS |
| FLIGHTS AND SHAFTS | DART CASES AND ACCESSORIES |

Fold here first.

Name	Date of Purchase
Address	Phone-Day
City	Phone-Evening
State Zip	Email
Purchase Price:	Item: 64-0913 Rebel Foosball Table
Store Name:	

Remember to attach a copy of your receipt.

This page is left intentionally blank.

Parts Order Form

Please call or consult the GLD website, gldproducts.com, to order the following parts.

Order No.	Description
3-347	Side Apron
3-348	End Apron
3-349	Support Brace
3-350	Playfield
3-351	Leg
3-324	Ball Entry Cup
3-352	Leg Leveler
3-332	3.5 x 35 mm Screw
3-329	3.5 x 18 mm Screw
3-330	3.5 x 12 mm Screw
27-0209	Soccer Ball
3-331	Scorers
3-353	4 x 40 mm Screw
3-334	3.5 x 12 mm Washer Head Screw
1-288	Allen Key with Phillips
3-335	M8 X 28 mm Bolt
3-336	M8 Washer
3-338	Grip - Molded
3-339	Rod End Cap
3-340	Bumper
3-341	Rod Washer
3-354	Player - Red
3-355	Player - Ivory
3-345	Bushing - Outside
3-346	Bushing - Inside
3-327	5-Player Rod
3-326	2-Player Rod
3-325	3-Player Rod



www.gldproducts.com

GAME TABLES

HOME CASINO

GAMES AND ACCESSORIES

BILLIARD CUES

BILLIARD ACCESSORIES

DARTBOARDS

SOFT-TIP DARTS

STEEL-TIP DARTS

FLIGHTS AND SHAFTS

DART CASES AND ACCESSORIES



PROUD MANUFACTURER OF

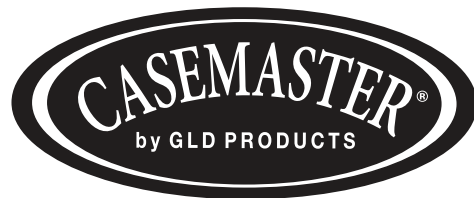

S84 W19093 Enterprise Drive • Muskego, WI 53150 USA
262.679.8730 or 1.800.225.7593 tele
262.679.8738 or 1.800.841.6944 fax
Email: gld@gldmfg.com
www.gldproducts.com