

Quick Start Guide

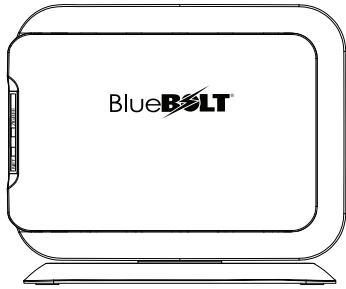

It is recommended that you read the entire list of instructions before proceeding.

Package Includes:

1. BB-ZB1
2. Vertical Mount Stand
3. Power Cord & Transformer
4. LAN Cable - CAT5E

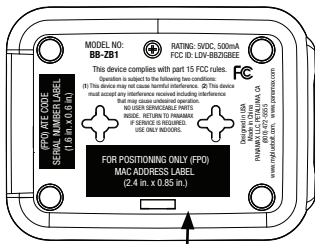

ATTENTION: PLEASE RETAIN MAC ADDRESS IDENTIFICATION NUMBER AND CHALLENGE KEY, WHICH APPEARS ON THE BACK PANEL OF THE BB-ZB1. This is unique to every BB-ZB1 unit and will be required for registration.

Installation:

- BB-ZB1 must be located in a relatively open area so that radio signal is not blocked.
- Unit may be mounted flat or vertically using the supplied stand. Can also be wall mounted or equipment rack mounted using keyhole slots on back of product.
- Connect power cord to BB-ZB1 and wall outlet.
- Connect LAN Cable from router to BB-ZB1.

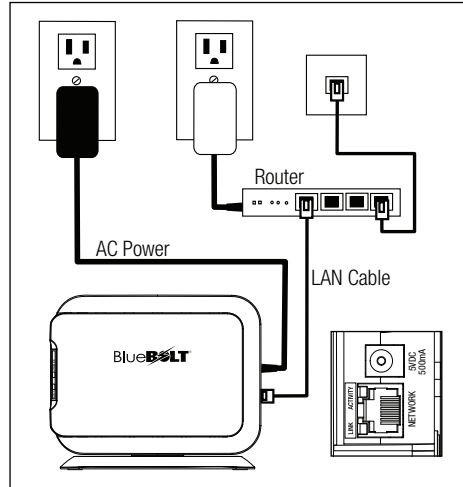

Ethernet indicators:

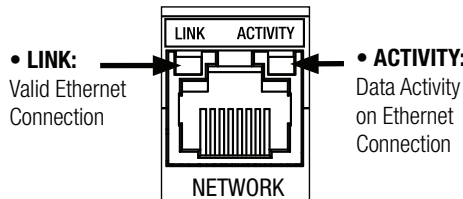

Network Indicator:

Indicates status of Internet connection.

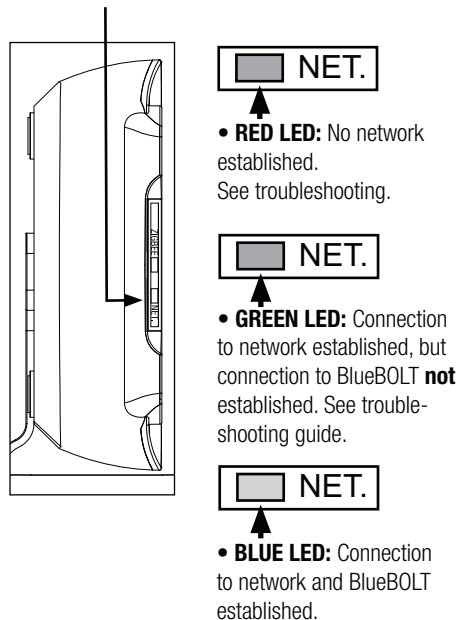

Zigbee® indicator:

Indicates status of ZigBee® network.

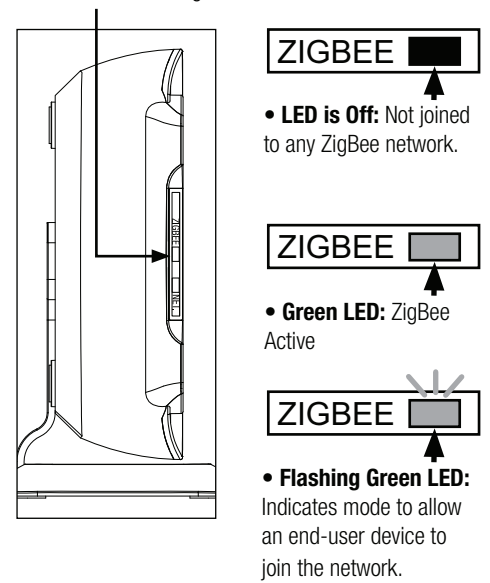

Reset Button for System Reset:

- If the reset button is pressed for *less* than 8 seconds, the system goes to startup mode.
- If the reset button is pressed for *more* than 8 seconds, the system restores all factory settings and goes to startup mode.

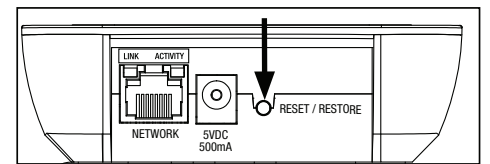

Online Registration:

Your BlueBOLT™ enabled Power Management Component is completely plug-and-play and does not require any software installation. The BlueBOLT™ control interface is operated through your web browser.

- 1) Using any Internet connected computer, go to www.mybluebolt.com using your standard Internet browser.
- 2) Follow the on screen instructions to create an account and/or take control of your BlueBOLT™ enabled product. Note: you will need the BlueBOLT-BB-ZB1's unique MAC address and challenge key (provided on the card's protective packaging as well as on the label of the card itself) in order to register the unit online.

Troubleshooting

Your BlueBOLT™ enabled Power Management Component (BB-ZB1) is completely plug-and-play and does not require any software installation. The BlueBOLT™ control interface is operated through your web browser.

1) Using any Internet connected computer, go to www.mybluebolt.com using your standard Internet browser.

2) Follow the on screen instructions to create an account and/or take control of your BlueBOLT™ enabled product. **Note:** you will need the BB-ZB1's unique MAC address and challenge key (provided on the label on the back of BB-ZB1) in order to register the unit online.

3) If BlueBOLT™ cannot detect your device within 20 seconds of inputting your MAC address and challenge key, please follow the on-screen troubleshooting guide. Also confirm the BB-ZB1 is properly connected to the Internet.

- Is your BB-ZB1 receiving power? Check the power cable and confirm the unit is on.
- Is your BB-ZB1 installed properly? The "Link" light should be illuminated (solid green) and the "Activity" light should be blinking intermittently (green).
- Is your Internet connection functioning?
- Can you access a general web page?
- Is your BB-ZB1 connected to your internet router or modem? Check the Ethernet cable and confirm that the unit is connected to an active Internet connection, and make sure those connected devices are receiving power.

If you have answered "Yes" to all of these questions and are still unable to connect your Power Management component, (BB-ZB1) contact Panamax/Furman customer service at 1-800-472-5555.

SERVICE

If you require technical support or equipment service, please contact the Service Department at 1-800-472-5555. All equipment being returned for repair must have a Return Authorization (RA) number. To get an RA number, call the Customer Service Department. Before returning any equipment for repair, be sure that it is adequately packed and cushioned against damage in shipment, and that it is insured. We suggest that you save the original packaging and use it to ship the product for servicing. Also, please provide a note with your name, address, phone number, RA number and a description of the problem.

LIMITED 1 YEAR WARRANTY

Panamax/Furman Limited Product Warranty: Panamax Inc. warrants to the purchaser of this product for a period of one (1) year from the date of purchase, that the unit shall be free of defects in design, material or workmanship, and Panamax Inc. will repair or replace any defective unit.

Full warranty information is available online at www.Panamax.com or www.FurmanSound.com.

FCC CLASS B DIGITAL DEVICE INFORMATION

NOTE: This equipment has been tested and found to comply with the limits for a Class B digital device, pursuant to part 15 of the FCC Rules and Industry Canada license-exempt RSS Standard(s). These limits are designed to provide reasonable protection against harmful interference in a residential installation. This equipment generates, uses and can radiate radio frequency energy and, if not installed and used in accordance with the instructions, may cause harmful interference to radio communications. However, there is no guarantee that interference will not occur in a particular installation. Changes or modifications not expressly approved by the party responsible for compliance could void the user's authority to operate the equipment.

Panamax LLC, 1690 Corporate Circle, Petaluma, CA 94954

707-283-5900 • 800-472-5555 • www.panamax.com • www.mybluebolt.com

©2012 Panamax LLC. Panamax, Furman and BlueBOLT logos are US registered trademarks of Panamax. ZigBee is a registered trademark of ZigBee Alliance, Inc.

PANAMAX
www.panamax.com

BlueBOLT
www.mybluebolt.com

FURMAN
www.furmansound.com