

Features

- Grip-Tight installation hardware makes it easy to fasten the seat – everything is done from above the bowl
- ReadyLatch® hinge provides a positive lock/unlock latch to securely hold seat in position, yet seat easily removes for cleaning or adjusting fit
- Quiet-Close™ elongated lid and seat prevents slamming
- Grip-Tight bumpers hold seat firmly in place
- Contoured seat for user comfort
- Color-matched plastic hinges
- Fits most elongated toilets

Material

- Plastic construction

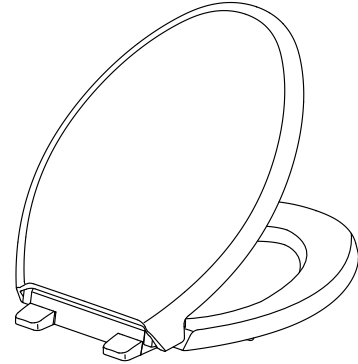

Codes/Standards









IAPMO/ANSI Z124.5

KOHLER® Toilets and Seats Limited Warranty

See website for detailed warranty information.

Available Colors/Finishes

Color tiles intended for reference only.

Color	Code	Description
	0	White
	96	Biscuit
	95	Ice™ Grey
	G9	Sandbar
	K4	Cashmere
	58	Thunder™ Grey
	7	Black Black™
	17	Teal
	42	Aspen Green

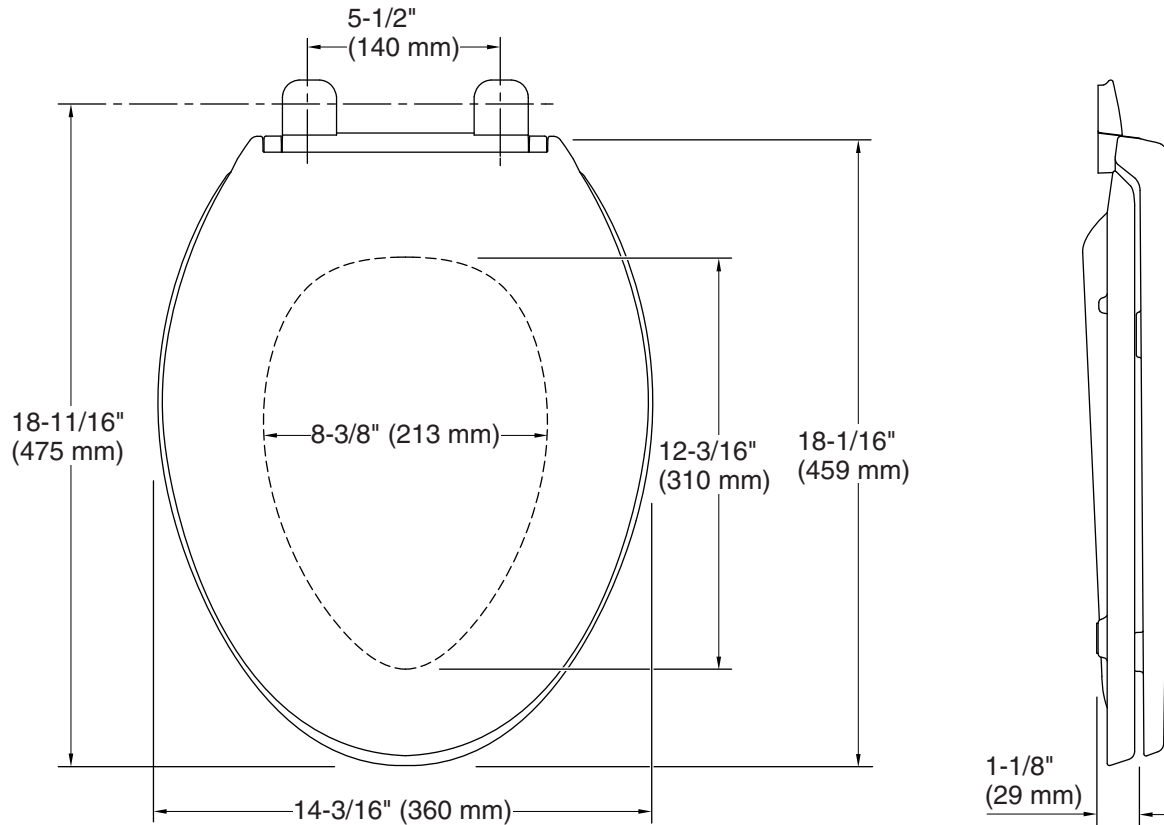

Technical Information

All product dimensions are nominal.

Seat shape type: Elongated
Seat front type: Closed-front
Seat-mounting holes: 5-1/2" (140 mm)

Pressure/fixture Supply Requirements