

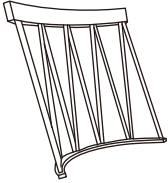







# ASSEMBLY INSTRUCTIONS

## ZIG-ZAG BACK WINDSOR SIDE CHAIR

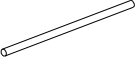
<b>A</b> Chair Back	<b>B</b> Left Leg	<b>C</b> Right Leg	<b>D</b> Seat	<b>E</b> Center Cross Bar
				
1pc	1pc	1pc	1pc	1pc
<b>F</b> Bolt with Lock Washer and Flat Washer 1/4", 1/4", 5/8" x 3/5"	<b>G</b> Pan Head Bolt 1/4" x 1-3/4"	<b>H</b> Lock Washer Ø11mm	<b>I</b> Flat Washer Ø13mm	<b>J</b> Allen Wrench 4mm
				
10pcs	3pcs	3pcs	3pcs	1pc

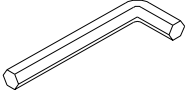
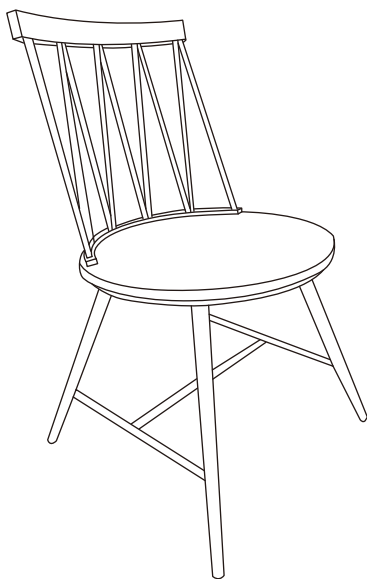

This page lists all the contents included in the box. Please take the time to identify the hardware as well as the individual components to this product. As you unpack and prepare for assembly, place the contents on a carpeted or padded area to protect them from damage.

- 
- 1** Invert Seat (D) and place it on a stable and smooth surface. Attach Left & Right Leg (B & C) to Seat (D) using Bolt with Lock Washer and Flat Washer (F) with Allen Wrench (J).

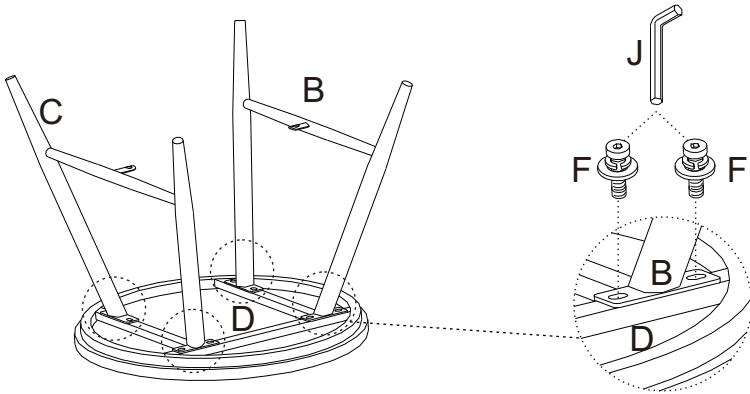

Take the Allen Wrench and turn the bolts until the legs are secured. **DO NOT TIGHTEN THE BOLTS COMPLETELY.** Stop when you feel you are adding force to tighten the bolt.

- 
- 2** Attach Center Cross Bar (E) to Left & Right Leg (B & C) using Bolt with Lock Washer and Flat Washer (F) with Allen Wrench (J).

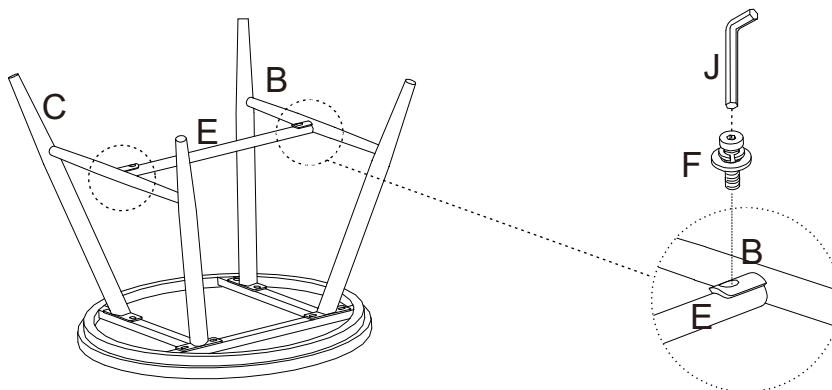

- 
- 3** Stand the chair base up. Attach Chair Back (A) to Seat (D) using Pan Head Bolt (G), Lock Washer (H) and Flat Washer (I) with Allen Wrench (J).

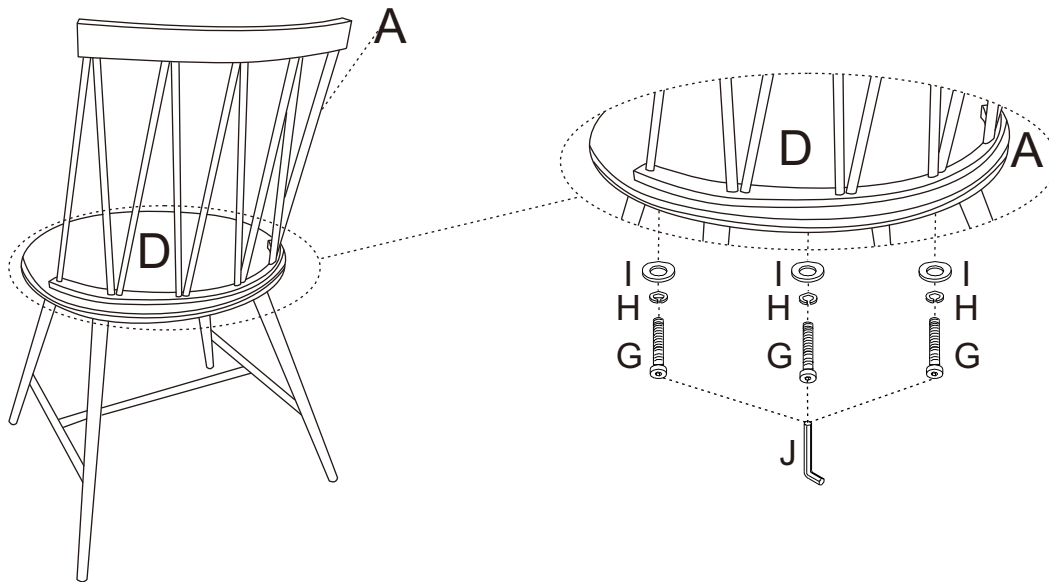

Stand the chair on an even surface and check for balance. If the chair wobbles slightly, apply downward pressure on the uneven leg and tighten the bolts to correct the imbalance. Once the chair is balanced, apply downward pressure evenly in the center of the chair and tighten all bolts, being careful not to over-tighten beyond the hole depth.

Helpful Tip: While tightening the bolts from underneath, have someone sit in the chair.

---

#### Cleaning & Care

Treat surfaces with care. Surfaces are resistant to scratches but are not scratch resistant. Clean surfaces with a dry or damp soft cloth. Do not use abrasive cleaners. Hardware may loosen over time. Periodically check that all connections are tight.