

010-1220

60 X 34 SHOWERCAST PORCELAIN ENAMEL SHOWER BASE CENTER ROUND DRAIN

Exterior Dimensions: 60W x 34D

Note: Dimensions may vary +/- 1/4"



Material to be stacked
on pallets.



COLOR & TRIM OPTIONS

Standard Color	Code
White	-00

FEATURES

- Base size: 60" x 34"
- Low profile curb height: 3"
- Construction:
 - Porcelain-finished steel construction
 - Full textured slip-resistant floor surface
 - Integrated weep channels for optimal drainage
 - Integral tile-flange for leak-prevention
 - Pre-leveled support pad for easier installation
 - Easy to clean, resistant to: bacteria, mold, mildew and stains
 - Square drain version available
 - Limited lifetime residential warranty
 - 3-Year commercial warranty

STANDARDS AND RATINGS*

- National Plumbing Code of Canada
- International Residential Code
- International Plumbing Code
- Uniform Plumbing Code
- MAS Certified Green
- ASME A112.19.1
- ASTM C282
- ASTM C448
- ASTM E162
- ASTM E662
- ASTM F462
- ASTM E303-22
- CSA B45.2
- WWP-541
- UL -969
- Applicable for LEED Credits
- HUD
- FHA
- VA

*Compliance effective where applicable
and installed accordingly





010-1220

60 X 34 SHOWERCAST PORCELAIN ENAMEL SHOWER BASE CENTER ROUND DRAIN

Note: Base dimensions may vary +/- 1/4"

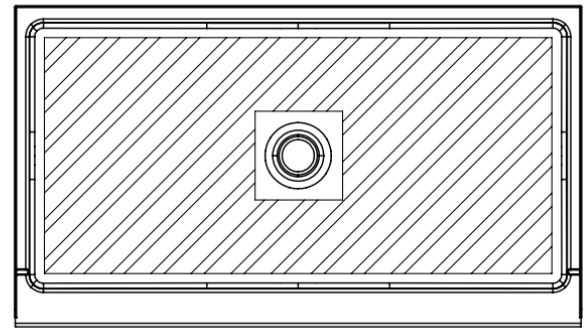
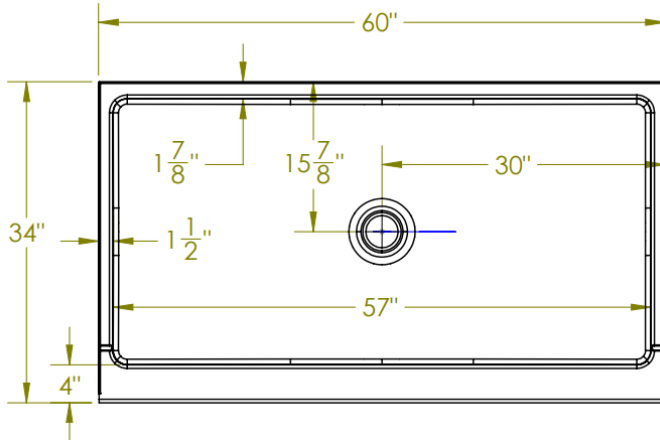

Shaded area represents anti-slip coverage



- All dimensions are approximate. Measurements should be verified against the unit to ensure proper fit

FEATURES Dimensional Tolerance $\pm 1/4$ ". Dimensions needed for site preparation should be measured from the unit. American Bath Group assumes no responsibility for preparatory work.

Type and Model #	Drain Side	Material	Surface
Shower Base #010-1220	Center	Porcelain on Steel	Porcelain Enamel w/ Anti-slip

DIMENSIONS

Specifications	inches
Shower Base Depth:	34
Shower Base Length:	60
Apron Height:	3
Step-Over Depth:	4
Shower Door Mountable Surface Depth*:	4

SUGGESTED DRAINS

Image	Description
	Solvent Weld type fitting similar to Oatey Part No. 42097
	Compression type "No-Caulk" fitting similar to Oatey Part No. 42099

Shower doors can only be attached to the shower base surface via adhesive, and cannot be drilled/nailed to the shower base surface