



Panic exit devices

ALPHA

Leading Safety Forward



MADE IN
ITALY

With Alpha, you are one step forward



Developed by CISA in collaboration with the **University of Florence's Laboratory of Ergonomics and Design** and a **team of industrial design experts**, Alpha is the latest range of CISA panic exit devices that stands out due to its extraordinary **ease of installation** and exceptional **reliability**.

With Alpha, CISA marks a new milestone in the evolution of panic exit devices, **pre-empting the requirements of the new European Regulation No. 2024/3110**.



UNIVERSITÀ
DEGLI STUDI
FIRENZE





Alpha **reduces the number of components** required and **simplifies assembly**, adapting to different configurations with minimal effort and the use of few tools, **optimising work time and methods**.

The **innovative ergonomic design, protected by a registered design model**, enhances the user experience, making every interaction smooth and safe and contributing to a contemporary, minimalist look.

Alpha is in compliance with the highest requirements of the European standards and guarantees **Made in Italy** excellence.



Alpha, where it all begins



Forty years on from the invention of the first panic exit device in Italy, **CISA writes a new chapter in the history of security.**

With Alpha, CISA drives change towards even **more advanced security performance** and **more practical, versatile and reliable installations**, to stay one step ahead.

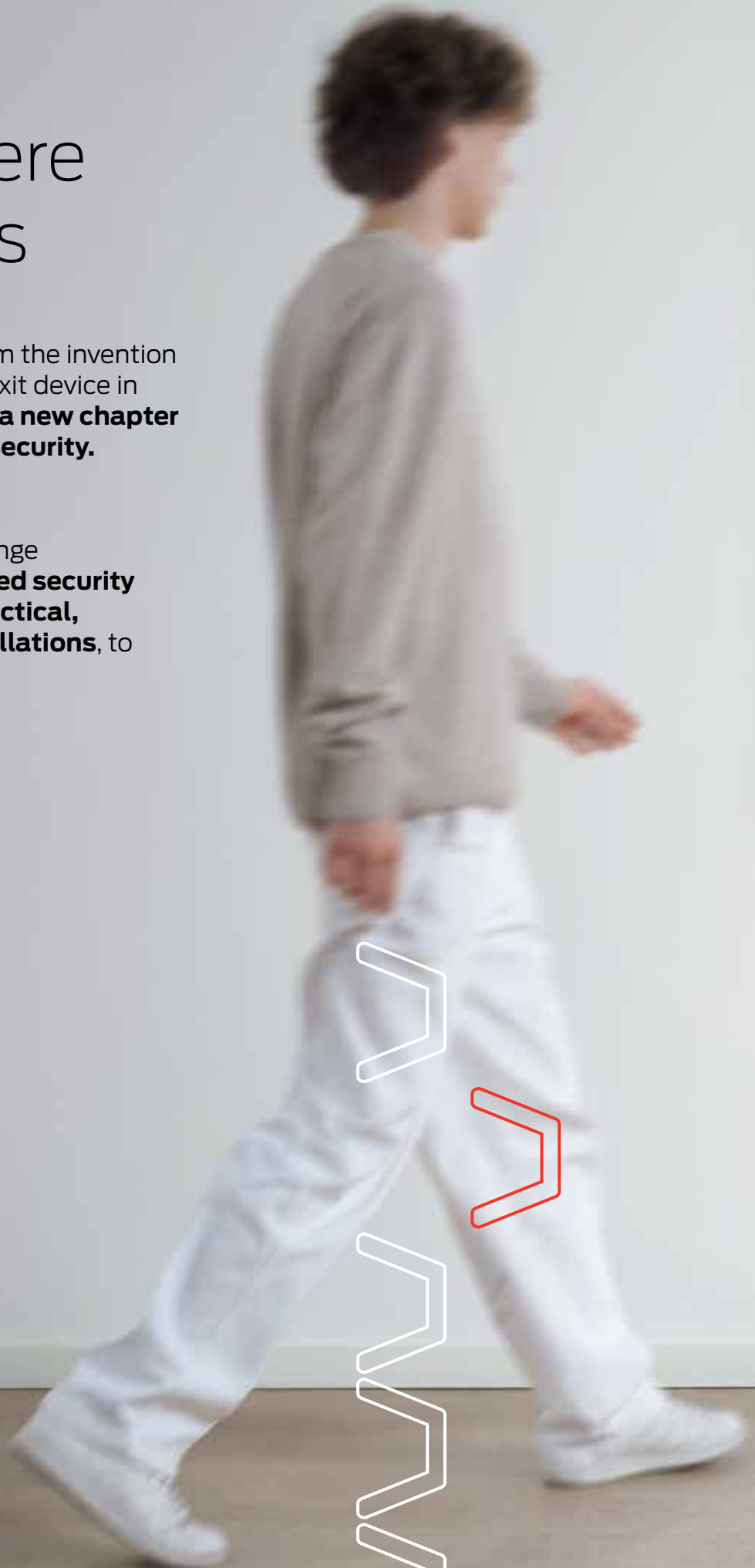

RELIABILITY THAT LASTS

Efficient component **design simplifies assembly** and ensures **quality performance** under **heavy-usage** conditions.

QUICK AND EASY INSTALLATION

The intuitive design and **reduced number of components saves** valuable **time during installation.**

FLEXIBLE CONFIGURATIONS

Alpha offers a **wide installation range** combining **aesthetic and functional variants of products,** outside access devices and accessories.

EFFORTLESS BAR OPENING

The **ergonomic grip** and the **increased contact surface reduce the effort** required to **open and close** the bar by 25%, improving safety and comfort of use.

Reliability that lasts



With Alpha, we are pre-empting the future: our products comply **with the new European Regulation No. 2024/3110**, guaranteeing superior performance and maximum durability.

In the **EMEA Testing Lab** at CISA, thousands of opening cycles test the strength and reliability of the panic exit device.

MAXIMUM BAR STABILITY

The angled shape of the **Alpha Push bar** ensures a **secure and stable attachment to the lever and a perfect, long-lasting hold**, eliminating any torsion, play or noise (**patent pending**).

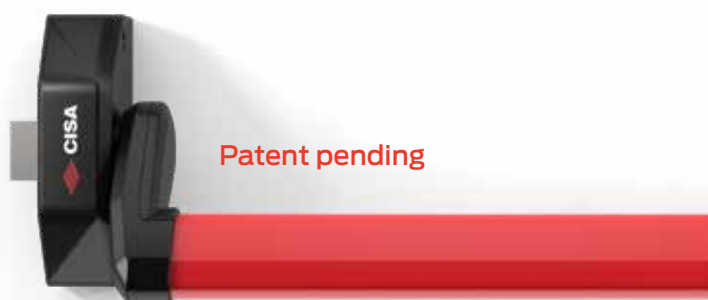

The **Alpha Touch bar** glides on wide, solid support surfaces, providing a **secure contact surface without oscillation, noise or friction** when opening and closing the door. Each component fits together perfectly, delivering a feeling of solidity and fluidity of movement. It can be shortened up to 300 mm.



SECURING WITHOUT SURPRISES

Thanks to the sliding pin insertion system, **the attachment of rods and cables is easy and safe**. When assembly is complete, the pin returns into position, preventing the elements from falling out.

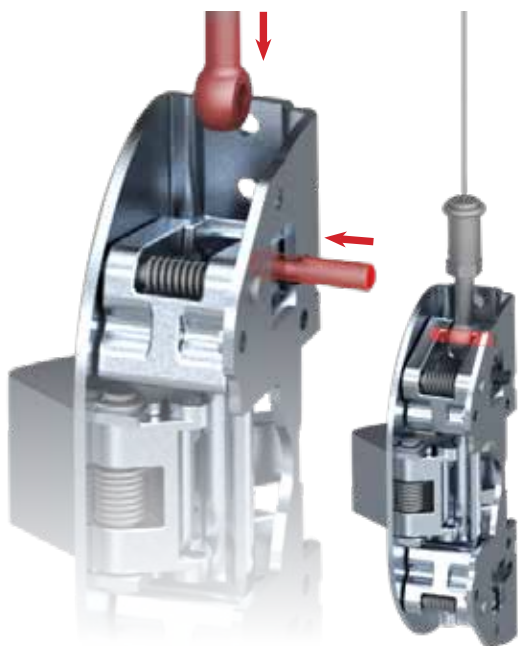

STRONGER COVERING ELEMENTS

The covering elements for mechanical parts, such as **covers and plastic plugs**, are **securely fastened by means of screws with a high load-bearing capacity**. This avoids the risk of loosening and increases impact resistance.

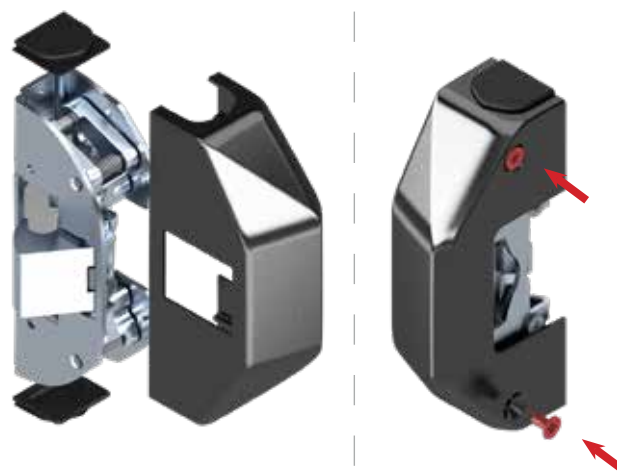

Quick and easy installation



With Alpha, we have gone a step further to offer you **quick and uncomplicated installation.**



Only two tools required for assembly



Easy measuring and cutting of bars



Universal hardware items



Quick and safe coupling system



Rapid hand changing

HARDWARE AND TOOLS REDUCED TO A MINIMUM

With only **three universal hardware items and two tools**, installation is faster than ever and the job is completed in minutes.

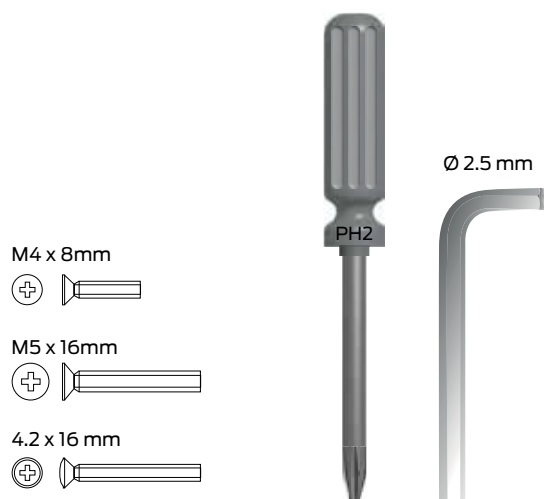

SIMPLIFIED CUTTING OF BARS

Thanks to the use of aluminium, **cutting of the bars is quick and easy**. We guide you in taking the exact measurements, drastically reducing the need for further operations.

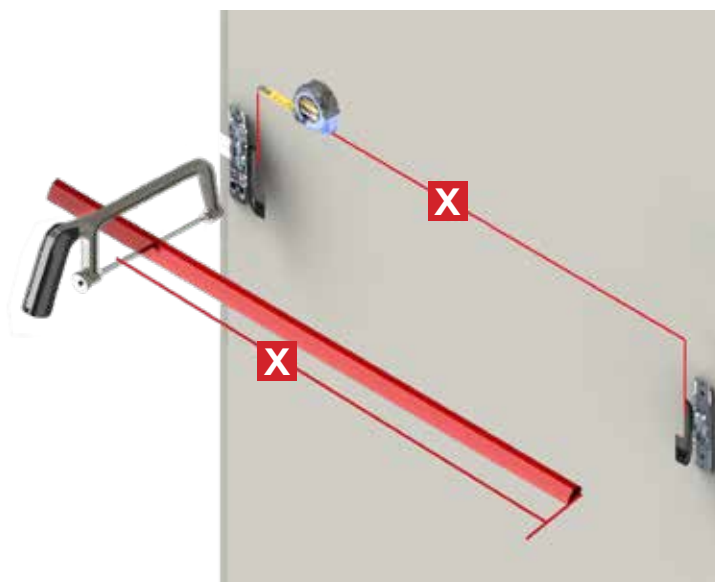

PERFECT MEASUREMENTS USING THE RIGID TEMPLATE

With the option of the **rigid template**, it becomes even **easier to take measurements and drill precise holes**.

Alignment of the additional locking points is quick and guarantees a perfectly aligned fixing, reducing installation time.



HAND CHANGING IN AN INSTANT

Alpha Push is **completely reversible**. For an uncomplicated hand change, simply release the pin (1), turn the lever (2) 180 degrees and finally lock the pin (3) again (**patent pending**).

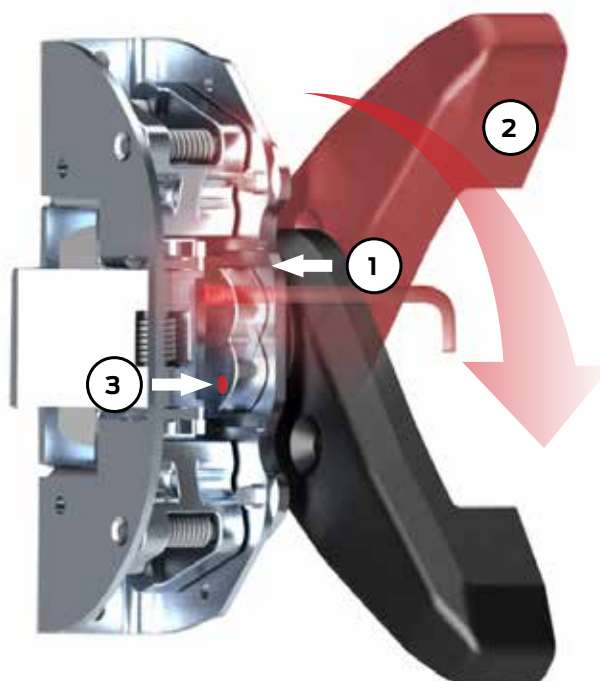

Smart installation, no worries



CISA provides you with **an installation guide** with step-by-step assistance. Discover all the combinations, details on mechanisms and simplify the assembly of Alpha panic exit devices.





**ASSEMBLY
INSTRUCTIONS**

Discover the digital
guide for assisted
installation



ALPHA

Flexible configurations



With Alpha, we have gone a step further to offer you **simple solutions to complex needs**, without limiting your choice.



COMPONENT MODULARITY

The interchangeability between the Touch and Push models simplifies installation. **Components common to the various configurations are easily recognisable** and the risk of errors is virtually zero, reducing installation time.

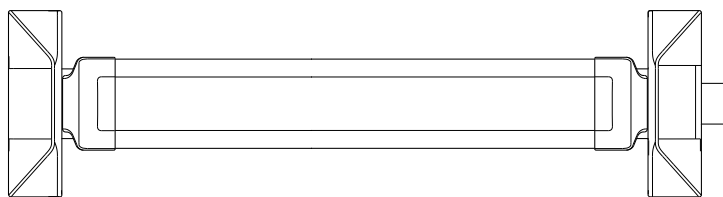
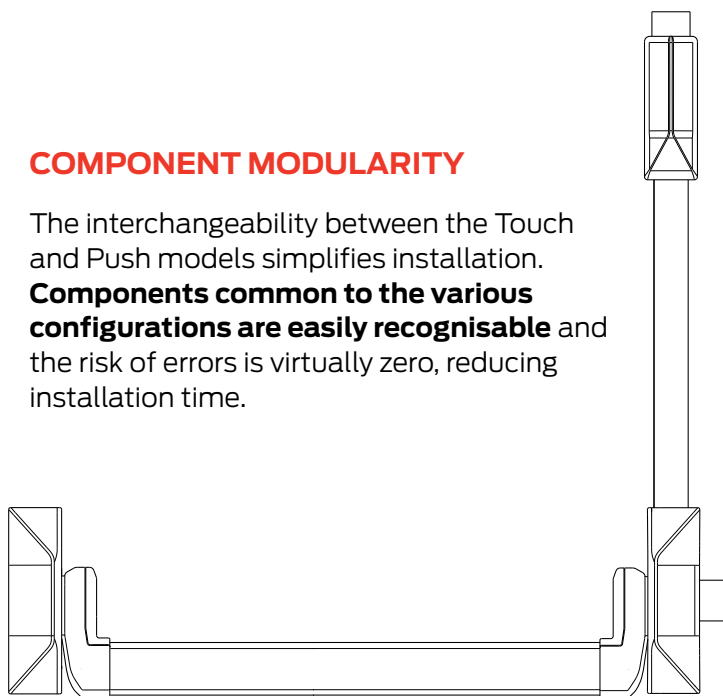

AUTOMATED ACCESSES

The motorised Touch version and the possibility of installing specific electric strikes allow the **Alpha Push and Touch range to be integrated with all access control systems.**

For the Touch version, it is also possible to upgrade to the motorised version by purchasing the motor separately.

INTERCHANGEABLE LOCKING POINTS

The additional locking points system makes it possible to **switch from cable (d) to rod (e) without the need to dismantle additional parts.**

The configuration is fully customisable with interchangeable kits.

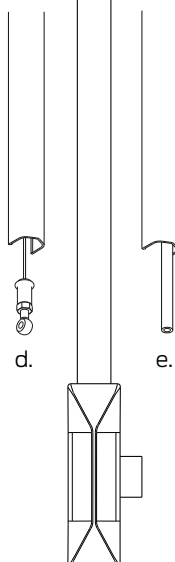

CHOICE OF OUTSIDE ACCESS DEVICES

Outside access devices are **available with handle (a) or fixed knob (b).**

A gear mechanism reduces the effort required to operate up to 3 locking points with the key (**patent pending**).

Reversible handle and key rotation in the opening direction (**patent pending**).

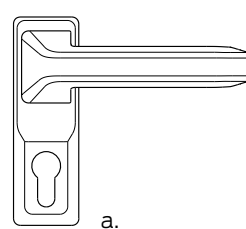

a.

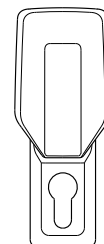

b.

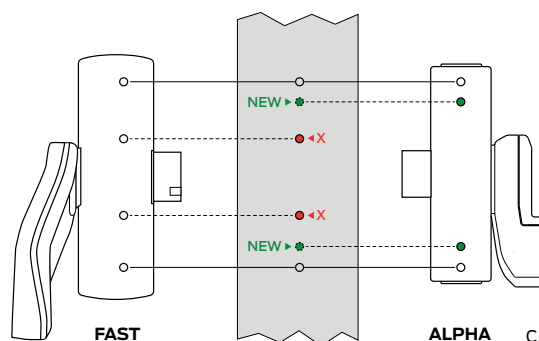

FAST

ALPHA

c.

EASY AND COMPATIBLE RETROFIT

The family feeling design of the Push and Touch models makes them **completely interchangeable** and ensures perfect coverage of the mechanism holes (c). Alpha models are also designed to **replace previous models without aesthetic impact.**

FOR ANY TYPE OF DOOR

Alpha is available in mortice and rim versions **for internal, perimeter and fire doors.**

The mortice fire door version is also suitable for standard doors from both a technical and regulatory standpoint, for optimal stock management.

Superior user experience



With Alpha, we have gone a step further to **improve the ergonomics of the product, for those who install it and for those who use it every day.**



SECURE GRIP AT ALL TIMES

The new fixed knob offers a **solid grip** that lends itself well to residential and commercial settings. The Touch bar has edges with protrusions for a **more secure grip**, while the Push bar has a diamond-shaped section that ensures **robustness without torsion**.

OPTIMISED HANDLING

Each component is designed to **facilitate the action of pushing and pulling**.

The cam mechanism guarantees unprecedented ease of opening (**patent pending**).

The improved ergonomics are also revealed during installation. Work takes place in convenient positions, aided by the use of templates for quick measurements.



MORE SPACE, FEWER OBSTACLES

Smaller dimensions and linear surfaces ensure a minimalist aesthetic look and at the same time a **wider and freer exit route**, with fewer obstructions and greater functionality.

GREATER PUSH SURFACE AREA

The new **square bar design** improves grip ergonomics and **increases the pushing surface area by 35%**. The result is easier and more effective pushing and pulling action, making **exiting faster and safer in an emergency**.





ALPHA TOUCH

The **TOUCH panic exit device** range combines robustness and refined design, with large contact surfaces that make opening and closing more emphatic and comfortable.

The ideal choice for those looking for harmonious aesthetics on double doors, available in a variety of colours and finishes that are perfectly coordinated with the door materials.



**GREATER PUSH
SURFACE AREA**



**EASY BAR INSERTION
AND SLIDING**



**PRE-FIXED
PLUG**

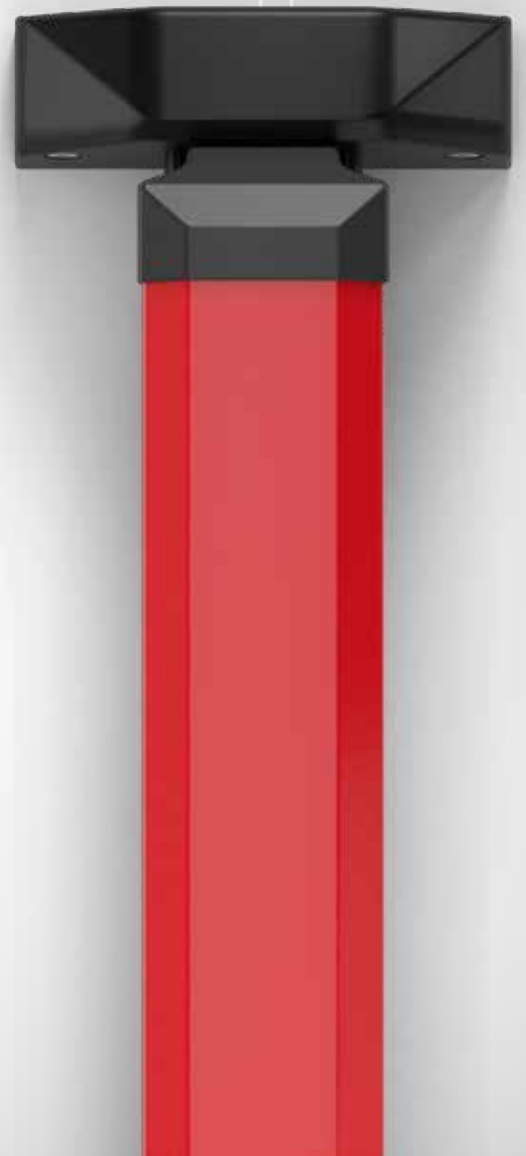



Alpha Touch technical features

Available in the rim version with single point locking and up to 3 locking points and in the mortice version in combination with Multitop Matic EXIT, SicurExit, Sicur Panic, Mito Panic, Exitlock, Heavy Duty panic function locks

Available bar lengths: 840/1200/1300 mm

Reduction of length up to 300 mm (mechanical version) or 600 mm (motorised version).

Fire door version available for both mortice and rim applications (Spec. FR)

Motorised rim (fire door version - Spec. FR) and mortice version

Standard configuration operation

From the inside: by pushing the bar

From the outside: with cylinder only or with outside handle or fixed knob access device

Hand

0 = non-handed

Supplied as standard

Strikers

Fixing screws

Installation and maintenance instructions

ICIM and CE certificates of compliance

On request:

Additional locking points for multi-point configurations for door heights up to 2,500 mm

Cable kit and extension rod kit for multi-point configuration

Extension rods for door heights up to 3,500 mm

Outside access devices.

Fast outside access devices kit for installation on Alpha series panic exit devices

Hold open device

Microswitch

Certifications and markings

CE marked according to (EU) Regulation No. 305/2011.

Voluntary product certification issued by the independent certifying body ICIM according to UNI EN 1125.

FINISHES AVAILABLE

Standard finish: black cover and red bar

Optional finishes:

PVD Fin. C2, SUPREME STEEL Fin. S1, MATT ALUMINIUM GREY Fin. P1, GREY fin. 97, WHITE Fin.45



ALPHA PUSH

The **PUSH panic exit device** range is characterised by an essential design that combines solidity and ease of installation.

The new ergonomic bar offers a secure and firm grip, supported by a patented lever attachment system that makes assembly intuitive and quick.



**PATENT
PENDING**



**ICONIC
DESIGN**



**MORE COMPACT
DIMENSIONS**



**EASY
INSTALLATION**





Alpha Push technical features

Available in the rim version with single point locking and up to 3 locking points and in the mortice version in combination with Multitop Matic EXIT, SicurExit, Sicur Panic, Mito Panic, Exitlock, Heavy Duty panic function locks

Available bar lengths: 900, 1200 and 1500 mm

Fire door version available for both mortice and rim applications (Spec. FR)

Standard configuration operation

From the inside: by pushing the bar

From the outside: with cylinder only or with outside handle or fixed knob access device

Hand

0 = non-handed

Supplied as standard

Strikers

Fixing screws

Installation and maintenance instructions

ICIM and CE certificates of compliance

To be ordered separately

900, 1200 or 1500 mm long horizontal bar (it can be shortened)

On request:

Additional locking points for multi-point configurations for door heights up to 2,500 mm

Cable kit and extension rod kit for multi-point configuration

Extension rods for door heights up to 3,500 mm

Outside access devices.

Fast outside access devices kit for installation on Alpha series panic exit devices

Hold open device

Microswitch

Certifications and markings

CE marked according to (EU) Regulation No. 305/2011.

Voluntary product certification issued by the independent certifying body ICIM according to UNI EN 1125.

FINISHES AVAILABLE

Standard finish: black cover and levers, red bar

Optional finishes

- Cover and levers: PVD Fin. C2, SUPREME STEEL Fin. S1, MATT ALUMINIUM GREY Fin. P1, GREY fin. 97, WHITE Fin.45

- Bar: PVD Fin. C2, SUPREME STEEL Fin. S1, MATT ALUMINIUM GREY Fin. P1, GREY fin. 97, GREEN Fin.43, BLACK Fin.44, WHITE Fin. 45

Outside access devices

The range of **outside access devices** is characterised by the versatility of options available for controlling access from the outside. Equipped with functional solutions for secure and comfortable access management, it is ideal for all types of doors, including main entrances.

The new fixed knob mechanism also allows opening in 3-point locking solutions. The handle has an improved lever for greater reliability.



Handle with cylinder

**MODULARITY:
UNIQUE FLUSH
MOUNTING AND RIM
VERSION**

**MORE ROBUST FLUSH
MOUNTING AND RIM
FIXED KNOB**

**VERSATILITY:
UP TO 3 LOCKING
POINTS**

**REVERSIBILITY:
REVERSIBLE HANDLE LEVER
AND KEY ROTATION IN THE
OPENING DIRECTION**



Fixed knob

Outside access device technical features

Outside access device with Handle

Rim or flush-mounted installation in door profiles

Version with cylinder and key (item 07A78380)

Version without cylinder (item 07A7838000SH)

Version with lowered handle for applications in reduced spaces (item 07A78360)

Apartment building function

Cylinder reversibility function

Right and left hand adaptable

Easy cylinder removal

Outside access device with Key and fixed knob

Rim or flush-mounted installation in door profiles

The key can operate up to 3 locking points

Fixed knob

Right and left hand adaptable

Easy cylinder removal

Supplied as standard

Fixing screws

Installation instructions

On request:

Security single cylinder, dimension 30-10

Installation kit for tubular cylinders

Extension kit for 80 to 130 mm thick doors (item 07A64800)

Fast outside access devices kit for installation on Alpha series panic exit devices

FINISHES AVAILABLE

Standard finish: Black

Optional finishes:

PVD Fin. C2, SUPREME STEEL Fin. S1, MATT ALUMINIUM GREY Fin. P1, GREY Fin. 97, WHITE Fin. 45

Additional locking points

The **additional locking points** for 2 or 3 locking point configurations, guarantee a secure door both when entering and exiting.

There is a wide choice: points can be oriented upwards, downwards or sideways, and connections to the main locking point can be made by rod or cable. Creating the ideal configuration is easy, thanks to the purchase codes available in the dedicated section.

 **WIDE RANGE OF CONFIGURATIONS**

 **CHOICE BETWEEN ROD AND CABLE**

 **VERSATILITY: UP TO 3 LOCKING POINTS**

Locking point
with cable



Locking point
with extension rod





Additional locking point technical features

2 top/bottom) locking points version

2 side locking points version

Additional side latch

For both, fire door version available (Spec. FR)

Supplied as standard

2 locking points and 2 covers

Strikers

Fixing screws

Installation and maintenance instructions

ICIM and CE certificates of compliance

To be ordered separately

Extension rod kit with rod cover

Cable kit with cable cover

On request:

Locking point extension rod kit for door heights up to 3,500 mm

Special locking points

2 special locking points for installation of double action doors

FINISHES AVAILABLE

Standard finish: Black

Optional finishes:

PVD Fin. C2, SUPREME STEEL Fin. S1, MATT ALUMINIUM GREY Fin. P1, GREY Fin. 97, WHITE Fin. 45

Push Pad

Push Pad is the ideal solution for installations on single or double leaf doors in premises with low footfall, as established by the UNI EN179 standard. Designed to **adapt to any type of door frame** – aluminium, PVC, wood or glass – **it combines modularity and ease of installation** thanks to an intuitive and reversible system.

Push Pad combines functionality, **tested reliability of up to 500,000 cycles**, and clean aesthetics for single or double leaf door installations.

The ergonomic, oversized design of the new push plate ensures a smooth and comfortable opening.



**EASY ASSEMBLY/
DISMANTLING**



**CONNECTIONS VIA
ROD OR CABLE**



**UP TO 3
LOCKING POINTS**



Push Pad technical features

Configuration with single locking point

Modular configuration with up to 3 locking points

Fire door version (Spec. FR)

Standard configuration operation

From the inside: push plate operation

From the outside: with cylinder or with outside handle or fixed knob access device

Hand

0 = non-handed

Supplied as standard

Strikers

Fixing screws

Installation and maintenance instructions

ICIM and CE certificates of compliance

On request:

Locking point extension rod kit for door heights up to 3,500 mm

Hold open device

Outside access devices

Additional locking points for configurations with up to 3 locking points

Cable kit and extension rod kit for configurations with up to 3 locking points

Certifications and Markings

CE marked according to (EU) Regulation No. 305/2011.

Voluntary product certification issued by the independent certifying body ICIM according to UNI EN 179.

Finishes available

Standard finish: Black

Optional finishes: PVD Fin. C2, MATT ALUMINIUM GREY Fin. P1, GREY Fin. 97, WHITE Fin. 45



PVD

PVD

Satin-finished stainless steel

Fin. C2

This finish is designed to defy the time. Manufactured using the innovative Physical Vapor Deposition vacuum coating

process, it guarantees **excellent resistance to salt spray, wear, corrosion, scratching, rubbing and weathering**, while

keeping the surface design intact, elegant and always the centrepiece.



Supreme Steel

Satin-finished

Fin. S1



Supreme Steel **offers remarkable performance in terms of resistance and reliability**, demonstrated by its **1,000 hours subject to salt spray**.

The gloss and protection of the surface treatment are the perfect combination for those who demand the ultimate in performance and style.



Aluminium Grey

Matt
Fin. P1



Matt Aluminium Grey is a **new finish with contemporary aesthetics** developed to be easily matched to aluminium profiles, lending character and originality to the installation.



Finishes

The elements in the Alpha range offer a wide variety of finishes, **which can be combined to create monochrome or contrasting solutions** with a high level of customisation.

All finishes are **available in both Touch and Push versions**, offering greater design versatility and allowing the best possible enhancement of any environment in which they are incorporated. To choose the most suitable finish, it is essential to consider both the intended use and the required level of resistance.

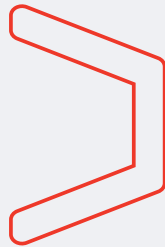

Bar Finishes Premium



PVD
Fin. C2



Supreme Steel
Fin. S1

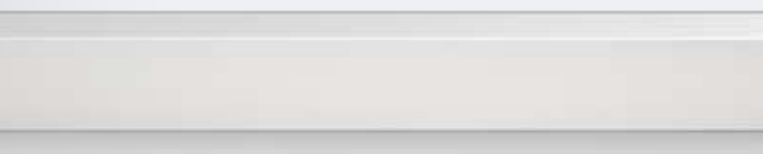

Aluminium Grey
Fin. P1



Bar finishes

Painted

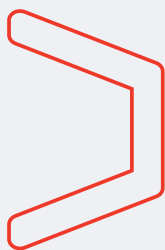

RED
RAL3000
Standard Fin.



GREY
RAL9006
Fin. 97

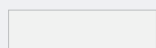
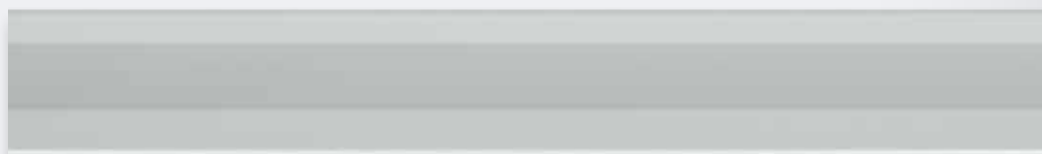

WHITE
RAL9010
Fin. 45

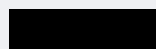
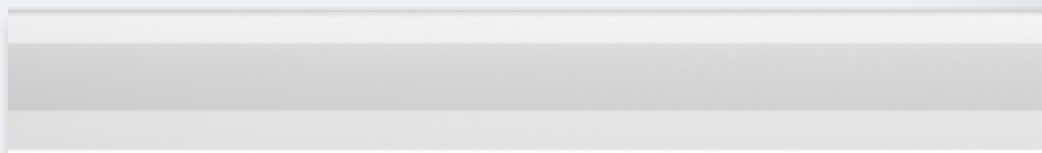

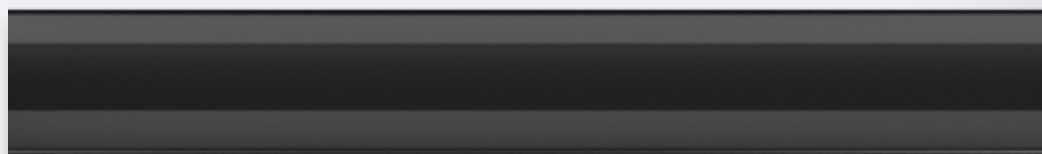

BLACK
RAL 9005
Fin. 44



GREEN
RAL6001
Fin. 43



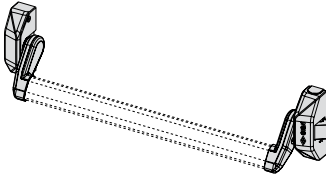

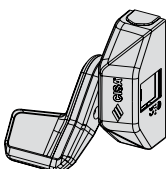
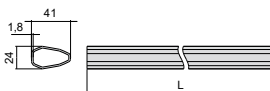

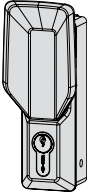
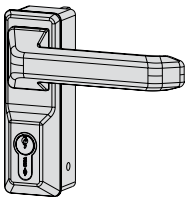
TYPE	DESCRIPTION	Optional finishes	L	kg		NO. PCS		ITEM					
				UNIT WEIGHT				TYPE	DIM.	HAND	FIN.	PERS.	SUFFIX
 <p>MOTORISED VERSION MODULAR VERSION</p> <ul style="list-style-type: none"> Side latchbolt with override option Standard finish: black cover and red bar Side strikers supplied as standard Can be used with 07A63 series additional locking points, operated by cable or rods Power supply cable (4 m) <p>On request:</p> <ul style="list-style-type: none"> Adjustable strikers Outside access devices series 07A78 	C2-P1-45-97	1300	3.760	1	1	5M851 09 0							
	C2-S1-P1-45-97	1200	3.472	1	1	5M851 10 0							
	C2-S1-97	1200	3.472	1	1	5M851 10 0 00 00 FR							
	C2-P1-45-97	840	3.000	1	1	5M851 11 0							
 <p>1 LOCKING POINT</p> <ul style="list-style-type: none"> Side latchbolt Standard finish: black cover and red bar Side striker supplied as standard <p>On request:</p> <ul style="list-style-type: none"> Adjustable striker Outside access devices series 07A78 	P1-97	1200	3.700	1	1	5M801 10 0							
	P1-97	840	2.684	1	1	5M801 11 0							
 <p>2 LOCKING POINTS</p> <ul style="list-style-type: none"> Without side latchbolt Standard finish: black cover and red bar Can be used with 07A63 series additional locking points, operated by cable or rods <p>On request:</p> <ul style="list-style-type: none"> Outside access devices series 07A78 	P1-97	1200	3.500	1	1	5M816 10 0							
			1200	3.500	1	1	5M816 10 0 00 00 FR						
	P1-97	840	3.000	1	1	5M816 11 0							
 <p>MODULAR VERSION</p> <ul style="list-style-type: none"> Side latchbolt with override option Standard finish: black cover and red bar Side striker supplied as standard Can be used with 07A63 series additional locking points, operated by cable or rods <p>On request:</p> <ul style="list-style-type: none"> Adjustable strikers Outside access devices series 07A78 	C2-S1-P1-45-97	1300	3.760	1	1	5M811 09 0							
	C2-S1	1300	3.760	1	1	5M811 09 0 00 00 FR							
	P1-97	1200	3.472	1	1	5M811 10 0							
	97	1200	3.472	1	1	5M811 10 0 00 00 FR							
	P1-97	840	3.000	1	1	5M811 11 0							
	97	840	3.000	1	1	5M811 11 0 00 00 FR							
 <p>MODULAR VERSION WITHOUT BAR</p> <ul style="list-style-type: none"> Side latchbolt with override option Standard finish: black cover Side striker supplied as standard Can be used with 07A63 series additional locking points, operated by cable or rods <p>On request:</p> <ul style="list-style-type: none"> Bar item 1 06A96 45 0 Adjustable strikers Outside access devices series 07A78 	C2-45-97	1300	3.472	1	1	5M811 09 0 00 SB							
			1300	3.472	1	1	5M811 09 0 00 SB FR						
 <p>Aluminium bar for panic exit device series 1.5M811.10.0.00.SB</p> <ul style="list-style-type: none"> Standard finish: painted red 	C2-S1-P1-43-44-97	1300	1.000	1	1	06A96 45 0							

TYPE	DESCRIPTION	Optional finishes	L	kg		NO. PCS		ITEM						
				UNIT WEIGHT				TYPE	DIM.	HAND	FIN.	PERS.	SUFFIX	
	1 LOCKING POINT	P1-97		2.150	1	1	5M001 10 0							
	<ul style="list-style-type: none"> Side latchbolt Standard finish: black cover and levers Side striker supplied as standard 	97		2.150	1	1	5M001 10 0 00 00 FR							
	<p>On request:</p> <ul style="list-style-type: none"> Horizontal bar series 07A07 Adjustable striker Outside access devices series 07A78 													
	2 LOCKING POINTS	P1-97		2.050	1	1	5M016 10 0							
	<ul style="list-style-type: none"> Without side latchbolt Standard finish: black cover and levers Can be used with 07A63 series additional locking points, operated by cable or rods 	97		2.050	1	1	5M016 10 0 00 00 FR							
	<p>On request:</p> <ul style="list-style-type: none"> Horizontal bar series 07A07 Outside access devices series 07A78 													
	MODULAR VERSION	C2-S1-P1-45-97		2.050	1	1	5M011 10 0							
	<ul style="list-style-type: none"> Side latchbolt with override option Standard finish: black cover and levers Side striker supplied as standard Can be used with 07A63 series additional locking points, operated by cable or rods 	C2-S1-97		2.050	1	1	5M011 10 0 00 00 FR							
	<p>On request:</p> <ul style="list-style-type: none"> Horizontal bar series 07A07 Adjustable strikers Outside access devices series 07A78 													
	MODULAR VERSION	C2-P1-45-97		1.020	1	1	5M061 10 0							
	<ul style="list-style-type: none"> Side latchbolt with override option Standard finish: black cover and lever Side striker supplied as standard Can be used with 07A63 series additional locking points, operated by cable or rods 	C2-S1-97		1.020	1	1	5M061 10 0 00 00 FR							
	<p>On request:</p> <ul style="list-style-type: none"> Adjustable strikers Outside access devices series 07A78 													
	Horizontal bar, to be combined with ALPHA Push panic exit devices	C2-S1-P1-44.45.97	900	0.545	1	1	07A07 20 0							
			1200	0.800	1	1	07A07 22 0							
		C2-S1-P1-43-44-45-97	1500	1.054	1	1	07A07 25 0							
	<ul style="list-style-type: none"> Standard finish: painted red 													

TYPE	DESCRIPTION	Optional finishes	kg		ITEM				
			UNIT WEIGHT	NO. PCS	TYPE	DIM.	HAND	FIN.	PERS.
	Fixed knob with cylinder <ul style="list-style-type: none"> • Suitable for standard or flush-mounted installation • Non-handed • Can be combined with ALPHA panic exit devices, including with 3 locking points • Standard finish: black, nickel-plated cylinder 	C2-S1-P1-45-97	0.600	1	1	07A78	35	0	
	Handle plate with lowered handle <ul style="list-style-type: none"> • Suitable for standard or flush-mounted installation • Non-handed • Handle disabled by key • Apartment building function: non-removable key setting • Standard finish: black, nickel-plated cylinder 	C2-97	1.100	1	1	07A78	36	0	
	Plate with handle <ul style="list-style-type: none"> • Suitable for standard or flush-mounted installation • Non-handed • Handle disabled by key • Apartment building function: non-removable key setting • Standard finish: black, nickel-plated cylinder 	C2-S1-P1-45-97	1.200	1	1	07A78	38	0	
	Version without cylinder supplied as standard	C2-S1-97	1.100	1	1	07A78	38	0	00 SH

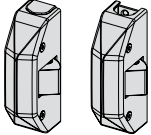
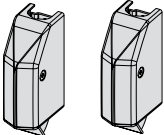
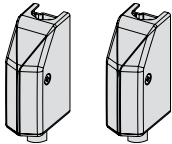
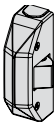
N.B.:

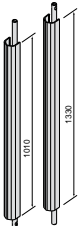
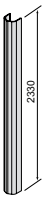
For integration into master key systems, the outside access device without cylinder (SH) must be ordered and the master keyed cylinder to be combined with the outside access device must be ordered separately.

TYPE	DESCRIPTION	Optional finishes	kg		NO. PCS		ITEM						
			UNIT WEIGHT				TYPE	DIM.	HAND	FIN.	PERS.	SUFFIX	
	Pair of latchbolts for side locking point • Strikers supplied as standard • Extension rod kit art. 1.07A63.0A.0 supplied as standard only on FR versions • Standard finish: black cover On request • Extension rod kit item 1.07A63.0C/0A.0	C2-SI-P1-45-97	1.950	1	1	07A63	51	0					
			C2-SI-97	1.950	1	1	07A63	51	0	00	00	FR	
	Pair of latchbolts for top/bottom locking points • Strikers supplied as standard • Extension rod kit art. 1.07A63.0A.0 supplied as standard only on FR versions • Standard finish: black cover On request • Extension rod kit item 1.07A63.0C/0A.0	C2-SI-P1-45-97	2.000	1	1	07A63	61	0					
			C2-SI-97	2.000	1	1	07A63	61	0	00	00	FR	
	Pair of deadbolts for top/bottom locking points • Strikers supplied as standard • Standard finish: black cover On request • Extension rod kit item 1.07A63.0C/0A.0	C2-SI-P1-45-97	2.000	1	1	07A63	71	0					
	Additional side latchbolt • Strikers supplied as standard • Standard finish: black cover		0.600	1	1	07A63	26	0					
	Extension rod kit with flexible cables • Standard finish: black cover Supplied as standard • 2 flexible cables • 2 rod covers • 2 cable guide clips	C2-SI-P1-45-97	0.500	1	1	07A63	0C	0					
	Extension rod kit • Standard finish: black cover Supplied as standard • 2 rods • 2 rod covers • 2 rod guide clips	C2-SI-P1-45-97	0.384	1	1	07A63	0A	0					
	Top extension rod kit with flexible cable • For doors with 3500 mm maximum height and horizontal bar 1100 mm from the floor • Standard finish: black cover Supplied as standard • Cable cover • Cable guide clip	C2-SI-P1-45-97	0.500	1	1	07A64	51	0					
	Top extension rod kit with rod • For doors with 3500 mm maximum height and horizontal bar 1100 mm from the floor • Standard finish: black cover Supplied as standard • Rod • Rod cover • Rod guide clip	C2-SI-P1-45-97	0.500	1	1	07A64	71	0					

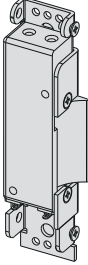
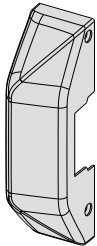
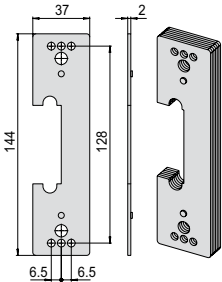
TYPE	DESCRIPTION	For item	kg		ITEM					
			UNIT WEIGHT	NO. PCS	TYPE	DIM.	HAND	FIN.	PERS.	
	Module without hold-open catch mechanism • 12 V AC - Absorbed current 0.48A		0.500	1	1	07A83	05	0		
	Module without hold-open catch mechanism • 12 V DC - Absorbed current 0.17A		0.500	1	1	07A83	06	0		
	Module without hold-open catch mechanism • 24 V DC - Absorbed current 0.10A		0.628	1	1	07A83	07	0		
	Module with energised coil • 12 V DC - Absorbed current 0.15A		0.634	1	1	07A83	40	0		
	Module with energised coil • 24 V DC - Absorbed current 0.10A		0.634	1	1	07A83	41	0		
	Module with microswitch • 12 V AC - Absorbed current 0.48A		0.634	1	1	07A83	80	0		
	Module with microswitch • 12 V DC - Absorbed current 0.17A		0.634	1	1	07A83	81	0		
	Module with microswitch • 24 V DC - Absorbed current 0.11A		0.634	1	1	07A83	82	0		
	Module with hold-open catch mechanism • 12 V AC - Absorbed current 0.8A		0.634	1	1	07A83	90	0		
	Cover for the electric strike module • Standard finish: black.	C2-S1-P1-45-97	0.200	1	1	06A98	12	0		
	Supplied as standard • 2 mm spacers in black nylon (5 pcs)									
	2 mm spacers in black nylon (5 pcs)	+39 45-97	0.020	1	1	07A89	12	0		
										

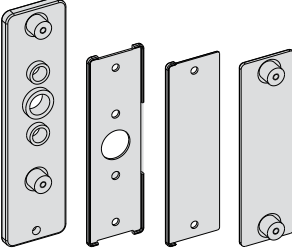
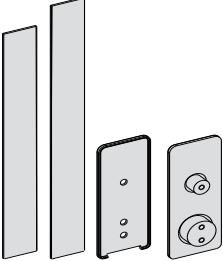
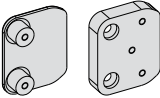
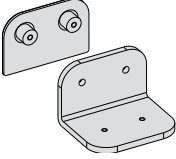
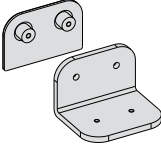
TYPE	DESCRIPTION	For item	kg	NO. PCS	ITEM				
			UNIT WEIGHT		TYPE	DIM.	HAND	FIN.	PERS.
	Glass kit for ALPHA panic exit devices • Finish: PVD satin-finished stainless steel treatment	5M001, 5M011 5M016 5M801 5M811 5M816	1,330	1	1	07A90	01	0	C2
	Glass kit for additional locking points for ALPHA panic exit devices • Finish: PVD satin-finished stainless steel treatment • Top extension rod 1330 mm • Bottom extension rod 1010 mm	1.07A63.51.0, 1.07A63.61.0, 1.07A63.71.0	2.500	1	1	07A90	10	0	C2
	Glass kit for side striker for ALPHA panic exit devices • Finish: PVD satin-finished stainless steel treatment	5M001 5M011 5M801 5M811 1.07A63.51.0	0.254	1	1	07A91	01	0	C2
	Glass kit for top striker, latchbolt version For additional locking points for ALPHA panic exit devices • Finish: PVD satin-finished stainless steel treatment	1.07A63.61.0	0.286	1	1	07A91	02	0	C2
	Glass kit for top striker For additional locking points for ALPHA panic exit devices • Finish: PVD satin-finished stainless steel treatment	1.07A63.71.0	0.240	1	1	07A91	03	0	C2

TYPE	DESCRIPTION	Optional finishes	kg		ITEM				
			UNIT WEIGHT	NO. PCS	TYPE	DIM.	HAND	FIN.	PERS.
	Adjustable striker for aluminium doors • Standard finish: black. Adjustments: • Coplanarity compensation from 8 mm to + 4 mm	+39 45-97	0.141	1	1	07072	31	0	
	Striker for factory doors/gates • Standard finish: black. Adjustments: • Clearance compensation between door wing and frame up to 25 mm • Coplanarity compensation from 4 mm to + 7 mm		0.080	1	1	07072	32	0	
	Striker for wood and PVC doors • Standard finish: black. Adjustments: • Cantilevered installation option on profiles with 14 to 24 mm overlap	+39 45-97	0.080	1	1	07072	33	0	
	Side/top steel striker for PVC doors • Standard finish: black.	+39 45-97	0.080	1	1	07072	34	0	
	Side/top striker with spacers (2 1.5 mm pcs) • Standard finish: black.	97	0.060	6	1	07072	11	0	
	Side/top corner striker with spacers • Standard finish: black.	+39 45-97	0.190	1	1	07072	21	0	
	Side/top corner striker with spacers • Standard finish: stainless steel		0.186	1	1	07072	71	0	

TYPE	DESCRIPTION	Optional finishes	kg		ITEM				
			UNIT WEIGHT	NO. PCS	TYPE	DIM.	HAND	FIN.	PERS.
	Hold-open device for ALPHA Touch panic exit devices • Standard finish: black.	C2-SI-P1-45-97	0.080	1 1	07A65	50	0		
	Hold-open device for ALPHA Push panic exit devices • Standard finish: black.	C2-SI-P1-45-97	0.080	1 1	07A65	51	0		
	Microswitch for ALPHA Touch panic exit devices		0.080	1 1	06A95	05	0		
	Microswitch for ALPHA Push panic exit devices		0.080	1 1	06A95	06	0		
	Extension kit for outside access devices • For item 1.07A78.36/38.0 on 80 to 130 mm thick doors • For item 1.07078.68.0 on 100 to 130 mm thick doors		0.099	1 1	07A64	80	0		
	Adapter kit for cylinder only, for ALPHA panic exit devices, rim version		0.080	1 1	06A98	90	0		
	Adapter kit for installation of the outside access device item 1.07078.68.0 in combination with ALPHA panic exit devices, rim version		0.080	1 1	06A98	91	0		
	Plastic mounting template kit		0.080	1 1	06A98	92	0		
	Kit for connecting FAST additional locking points with ALPHA panic exit devices, rim version		0.080	1 1	06A98	93	0		

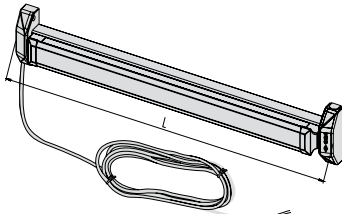
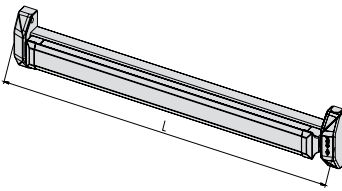
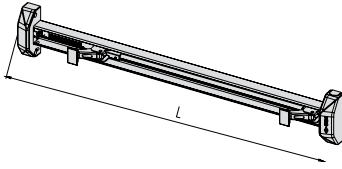
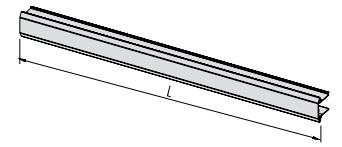
TYPE	DESCRIPTION	Optional finishes	L	kg		NO. PCS		ITEM						
				UNIT WEIGHT				TYPE	DIM.	HAND	FIN.	PERS.	SUFFIX	
	MOTORISED VERSION • Power supply cable (4 m) • Standard finish: black cover, red bar • To be combined with Mito Panic lock item 1.43112.65.0 and safety locks item 1.43192.65.0, 1.43193.65.0 for installation on double-leaf doors			C2-P1-97	1200	3.760	1	1	5M751	00	0	00	00	FR
				C2-S1--P1-97	840	3.472	1	1	5M751	01	0	00	00	FR
	• Standard finish: black cover and red bar • To be combined with locks series Mito Panic, Mito Sensor, Multitop Matic Exit, SikurExit and Heavy Duty • To be combined with Exitlock and Sicur Panic series locks			C2-S1-P1-45-97	1200	3.360	1	1	5M711	00	0	00	00	FR
				C2-P1-45-97	840	2.600	1	1	5M711	01	0	00	00	FR
				C2-P1-97	1300	3750	1	1	5M711	06	0	00	00	FR
				C2-S1-P1-45-97	1200	3.360	1	1	5M711	10	0	00	00	FR
				C2-P1-97	840	2.600	1	1	5M711	11	0	00	00	FR
				C2-P1-97	1300	3750	1	1	5M711	16	0	00	00	FR
	VERSION WITHOUT BAR • Standard finish: black cover • To be combined with locks series Mito Panic, Multitop Matic Exit, SikurExit and Heavy Duty • To be combined with Exitlock and Sicur Panic series locks			97	1200	3.760	1	1	5M711	00	0	00	SB	FR
				C2-P1-97	1300	3.472	1	1	5M711	06	0	00	SB	FR
				C2-P1-97	1300	3.760	1	1	5M711	16	0	00	SB	FR
	Bar for panic exit devices series 1.5M711.00.0.00.SB.FR 1.5M711.06/16.0.00.SB.FR • Standard finish: red			C2-S1-P1-43-44-97	1300	1.000	1	1	06A96	45	0			

TYPE	DESCRIPTION	Optional finishes	CENTRE DIS-TANCE	 UNIT WEIGHT NO. PCS		ITEM						
				TYPE	DIM.	HAND	FIN.	PERS.	CAR.			
	<ul style="list-style-type: none"> Standard finish: black cover and levers On request: Horizontal bar series 07A07 											
	<ul style="list-style-type: none"> To be combined with Mito Panic, Multitop Matic EXIT, SikurExit panic function locks. Heavy Duty 	C2-S1-P1-45-97		2.050	1	1	5M607	10	0	00	00	FR
	<ul style="list-style-type: none"> To be combined with Sicur Panic, Exitlock panic function locks 	C2-S1-P1-45-97		2.050	1	1	5M608	10	0	00	00	FR
	<ul style="list-style-type: none"> Standard finish: black cover and levers On request: horizontal bar series 07A07 											
	<ul style="list-style-type: none"> To be combined with Mito Panic, Mito Sensor panic function locks 	C2-S1-P1-97	72	2.050	1	1	5M617	00	0	00	00	FR
	<ul style="list-style-type: none"> To be combined with Multitop Matic EXIT, SikurExit panic function locks. 	C2-S1-P1-97	92	2.050	1	1	5M617	12	0	00	00	FR
	<ul style="list-style-type: none"> To be combined with Sicur Panic panic function locks 	C2-S1-97	92	2.050	1	1	5M618	12	0	00	00	FR
	Horizontal bar, to be combined with ALPHA Push panic exit devices <ul style="list-style-type: none"> Standard finish: painted red 	C2-S1-P1-44.45.97	900	0.545	1	1	07A07	20	0			
		C2-S1-P1-44.45.97	1200	0.800	1	1	07A07	22	0			
		C2-S1-P1-43-44-45-97	1500	1.054	1	1	07A07	25	0			

TYPE	DESCRIPTION	Optional finishes	L	kg		ITEM					
				UNIT WEIGHT	NO. PCS	TYPE	DIM.	HAND	FIN.	PERS.	SUFFIX
	Internal plate for ALPHA Touch and ALPHA Push panic exit devices, mortice version • Standard finish: black.	C2-S1-P1-45-97	72	0110	6	1	07A76	61	0		
		C2-45-97	85	0110	6	1	07A76	62	0		
		C2-S1-P1-45-97	92	0110	6	1	07A76	63	0		
	Internal plate for ALPHA Touch and ALPHA Push panic exit devices, mortice version • Standard finish: black.	C2-S1-P1-45-97	-	0,110	6	1	07A76	66	0		

TYPE	DESCRIPTION	For item	kg		ITEM					
			UNIT WEIGHT	NO. PCS	TYPE	DIM.	HAND	FIN.	PERS.	
	CISA MOTOR, for powering ALPHA Touch mechanical panic exit devices. It allows electric remote opening • Voltage 12/24V AC/DC • Absorbed current: 2A • Power supply cable, length 4 m	5M700-5M800	0.400	1	1	E0000	00	1		
	Power supply cable, length 4 m	E0000	0.600	1	1	07A30	40	0		
	Power supply cable, length 10 m		1.500	1	1	07A30	42	0		

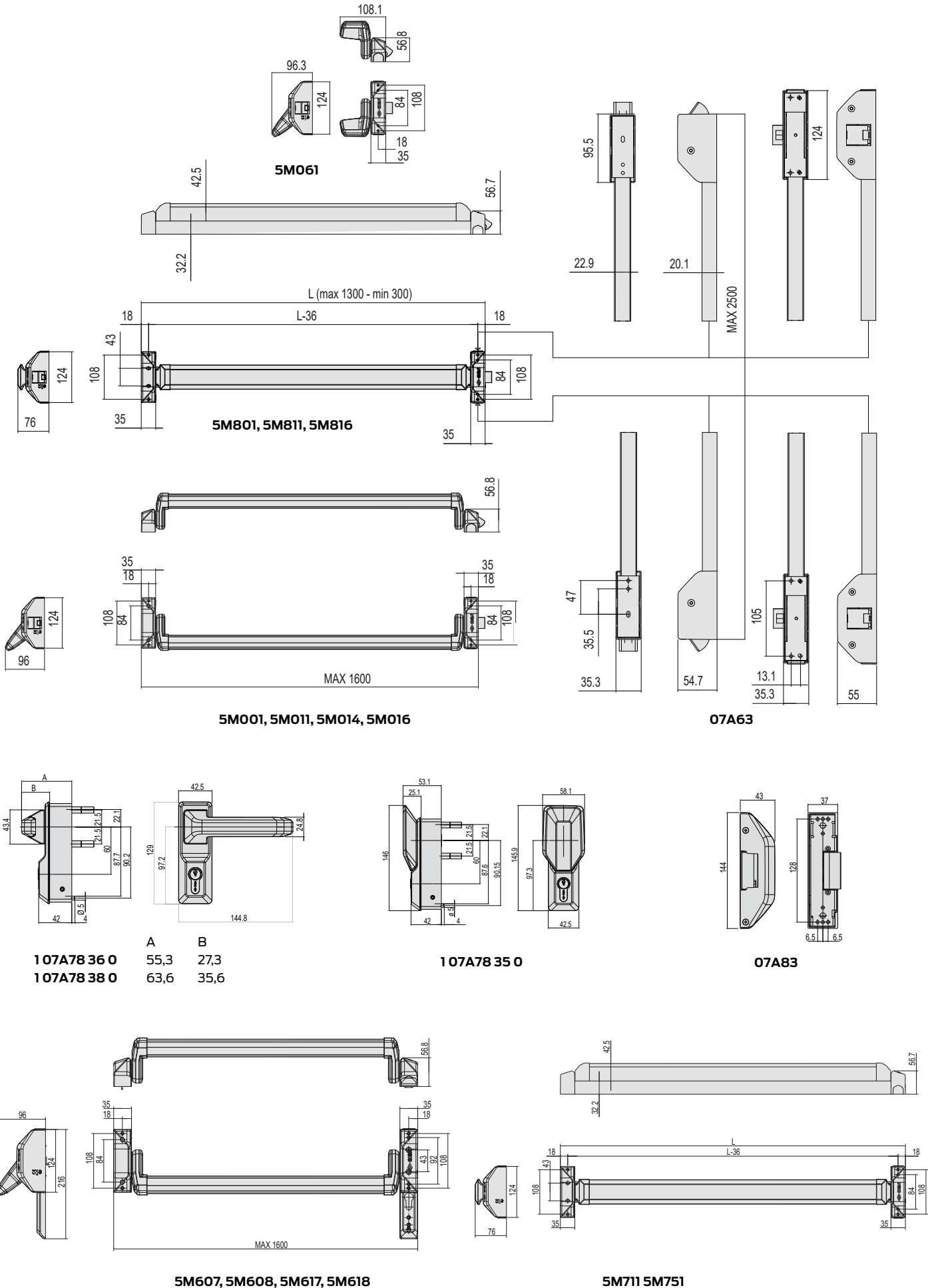

About Allegion

At Allegion (NYSE: ALLE), we design and manufacture innovative security and access solutions that help keep people safe where they live, learn, work and connect. We're pioneering safety with our strong legacy of brands like CISA®, Interflex®, LCN®, Schlage®, SimonsVoss® and Von Duprin®. Our comprehensive portfolio of hardware, software and electronic solutions is sold around the world and spans residential and commercial locks, door closer and exit devices, steel doors and frames, access control and workforce productivity systems.

For more, visit allegion.com.



 CISA SpA
Via Oberdan 42
48018 Faenza (RA) Italy

 Ph. +39 0546 677111
Fax +39 0546 677150

 Customer Service and Technical Support
+39 0546 188 0070

    cisa.com
cisa.vendite@allegion.com