

# FLEXSTEEL®

## Power Reclining Sofa with Console, Power Headrest, Lumbar, Heat and Massage

### IMPORTANT NOTE

Read these instructions carefully, and familiarize yourself with each procedure before assembling the furniture. Check that you have all the component parts and familiarize yourself with each part before proceeding. Take all the fitting out of the plastic bag and separate them into groups. Ensure you have enough space to lay out all the parts before assembly. To prevent damage to the parts, we recommend that you assemble the unit on a soft, flat surface.

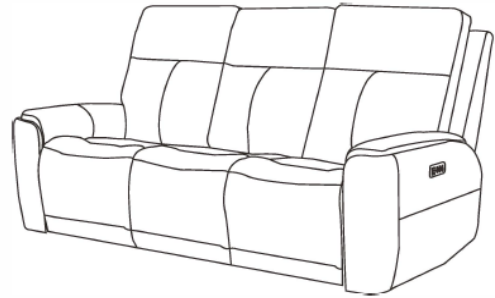

### Part List

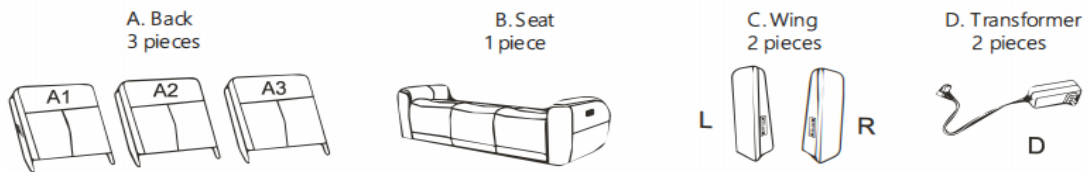

### Assembly Instructions

#### STEP 1

Take out the Transformers (D) and Wings (C) from the bottom of the seat. (See Figure 1)

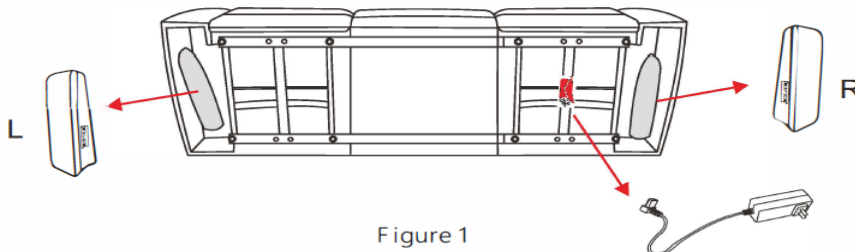

Figure 1

#### STEP 2

Attach the Backs (A1), (A2) & (A3) to the Seat (B). Ensure the brackets fit tightly. Then attach the Wings (C) to Left and Right Backs (A1 & A3). Ensure the latches fit well. (See Figure 2)

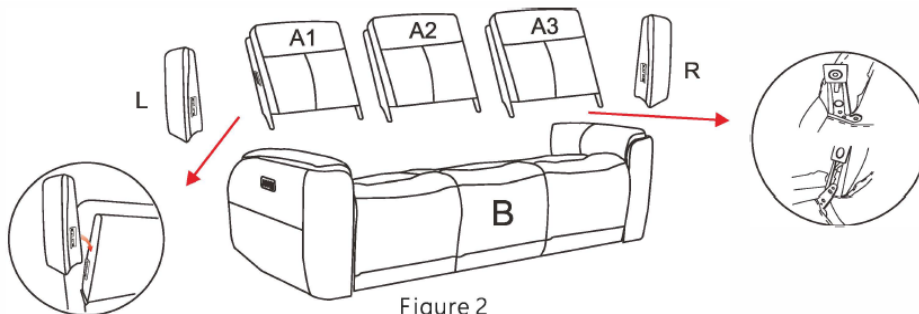

Figure 2

#### STEP 3

Zip the fabric on bottom of Backs (A1 & A3) with back of Seat (B). (See Figure 3).

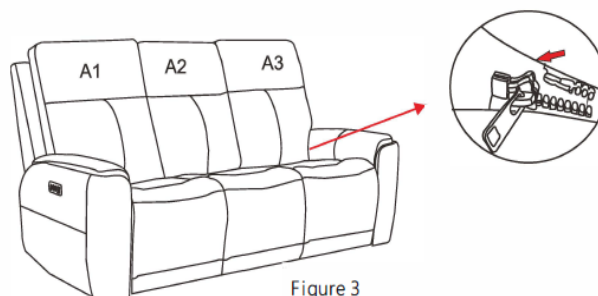

Figure 3

## STEP 4

Flip up the back flap, and remove the cables from the Left and Right Backs (A1 & A3). Connect the cables with red labels together, and then connect cables with labels A to A, B to B, C to C. (See Figure 4)

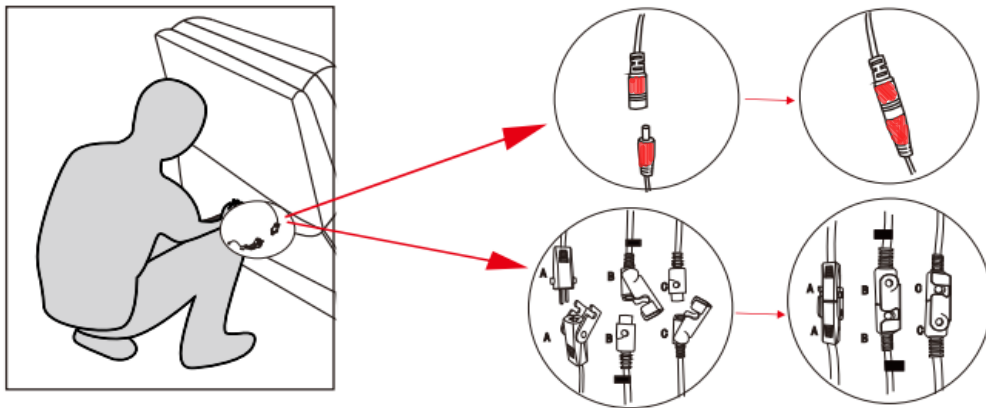

Figure 4

## STEP 5

Connect the transformers (D) into the power ports on the back of the left & right seats on the seat (B). Remove the cable from behind the back flap of the center back (A2). Plug this cable and the transformers (D) into nearby outlets, ensuring the cables are clear from the metal base. (See Figure 5) Fasten the back flaps to the bottom of the furniture. (See Figure 6)

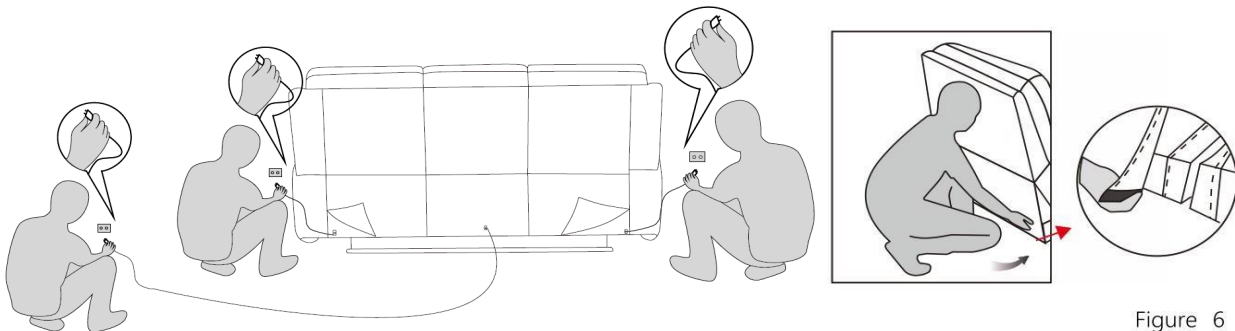

Figure 5

Figure 6

## Back Disassembly

Pull up the spring leaf in bracket, then lift Back (A) up. Unzip the black fabric on bottom of back from back of seat. Disconnect all of the cables behind the backs. (See figure 7)

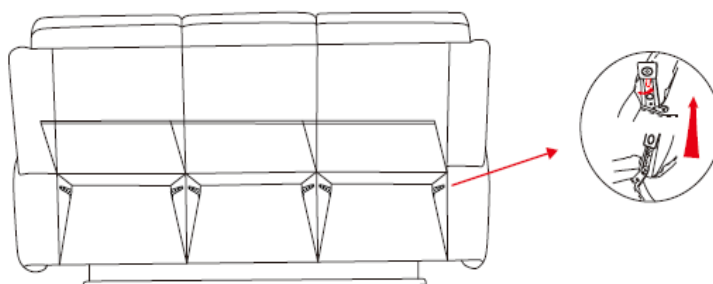

Figure 7

# User Guide for Wireless Charger

## Attention



1. It is common for heat to be generated in wireless charging through the energy transfer process. This is part of the normal wireless energy transfer.
2. Phone should be centered on the wireless charging icon if an icon is present. The further the current must travel, charging efficiency is reduced and more energy is lost to heat.
3. Phone should be centered on the tray if an icon is not present. The further the current must travel, charging efficiency is reduced and more energy is lost to heat.
4. Make sure there aren't any foreign objects on the charger when charging. This can cause the charger to start stop multiple times if the foreign object detector senses an object.
5. Make sure to disconnect the phone from Apps and WiFi during wireless charging while charging and don't use the phone while wireless charging.

### IMPORTANT NOTE

- To avoid any risk of suffocation to children or pets dispose of all plastic bags immediately
- To ensure proper performance occasionally check for loose screws and tighten as needed.
- If the reclining functions are not working properly, check for loose cable connections before contacting the retailer.