

Finish: 58-405
Height: 4.28 in
Diameter: 2.38 in
Volume/Overflow: 8.13 fl. oz.

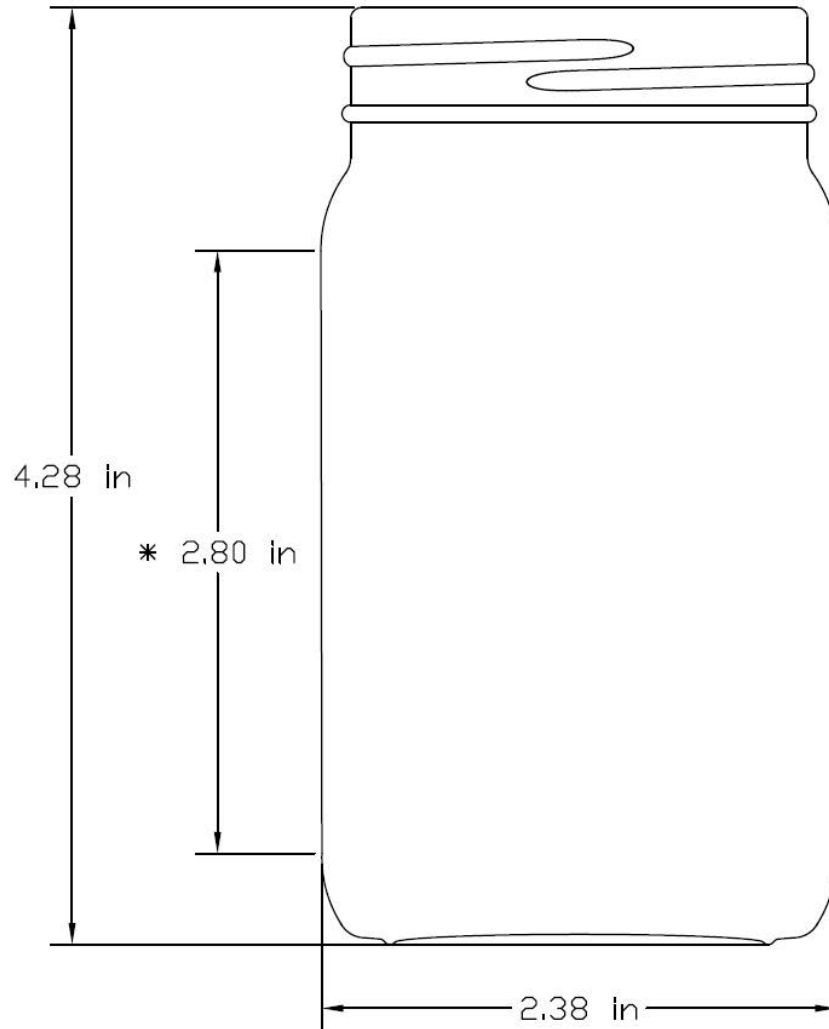

DISCLAIMER

THIS INFORMATION IS PROVIDED AS A GENERAL GUIDE, INCLUDING DIMENSIONS. IT IS THE CUSTOMER'S RESPONSIBILITIES TO SELECT THE PROPER CONTAINER FOR PRODUCT AND APPLICATION COMPATIBILITY.

DISTRIBUTED BY:



REF NO.:

DESCRIPTION: