

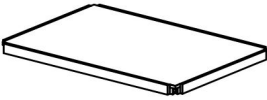

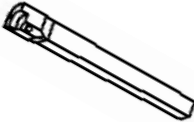

ASSEMBLY INSTRUCTION

FAUX MARBLE 54" RECTANGULAR DINING TABLE

A Table Top  1 pc	B Table Leg  4 pcs	C JCBB Bolt M8 x 60mm  8 pcs	D Lock Washer M8  8 pcs
E Flat Washer M8 x 16mm  8 pcs	F Allen Key M5  1 pc		

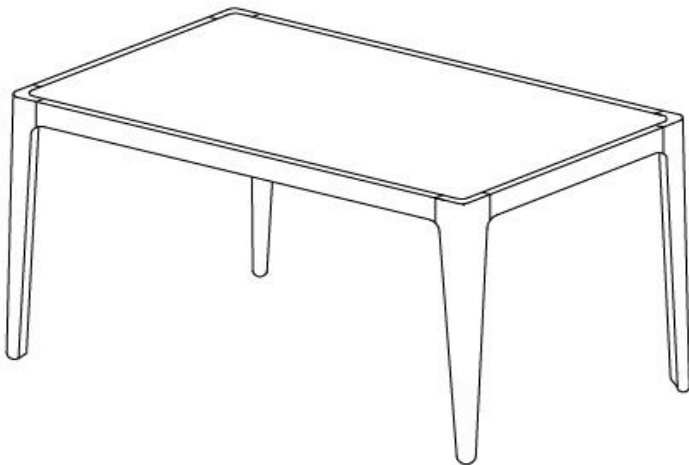

This page lists all the contents included in the box. Please take the time to identify the hardware as well as the individual components to this product. As you unpack and prepare for assembly, place the contents on a carpeted or padded area to protect them from damage.

- 1 Place the Table Top (A) upside down on a smooth carpeted surface. Place the Table Leg (B) to the position, aligning the holes of the Table Leg (B) with apron on the Table Top (A) as shown below. Then insert JCB Bolt (C), Lock Washer (D) and Flat Washer (E) with Allen Key (F). Fully tighten all the bolts.

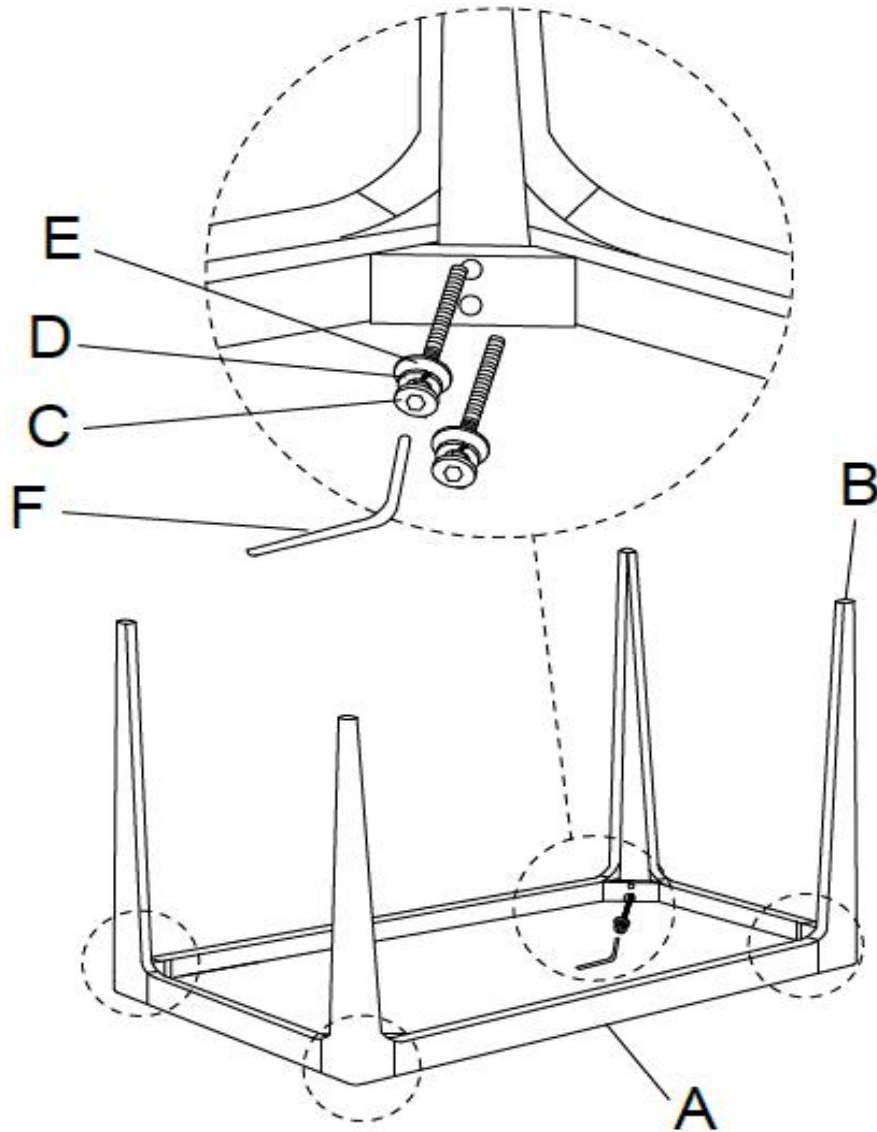

Cleaning & Care

Treat surfaces with care. Surfaces are resistant to scratches but are not scratch resistant. Clean surfaces with a dry or damp soft cloth. Do not use abrasive cleaners. Hardware may loosen over time. Periodically check that all connections are tight.