

ASSEMBLY AND INSTALLATION INSTRUCTIONS

P0388

WARNING: TO AVOID RISK OF ELECTRICAL SHOCK, BE SURE TO SHUT OFF POWER WHILE INSTALLING OR SERVICING THIS FIXTURE.

NOTE: 1. Before installing, consult local electrical codes for wiring and grounding requirements.
2. READ AND SAVE THIS INSTRUCTIONS.

Hardware Package (included):

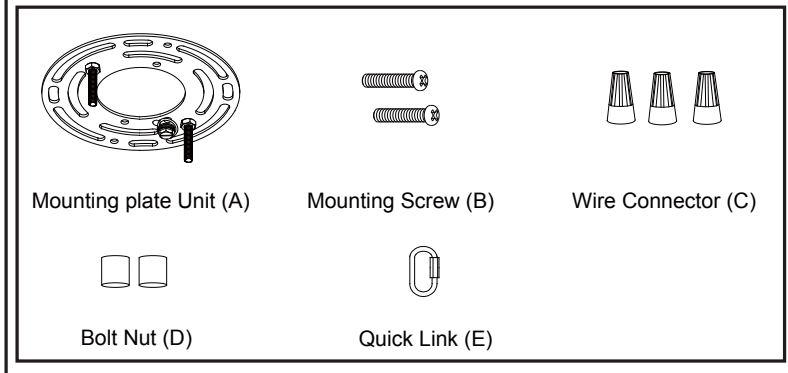

Installation Steps

Turn off the power at fuse or circuit box

1. Attach the mounting plate unit (A) to the outlet box by using two mounting screws (B).
2. Rod connections:
 - a. Thread the fixture wire from the fixture through the lower rod, then secure the lower rod onto fixture using the threaded pipe.
 - b. Thread the fixture wire through the middle rod, and then secure the middle rod onto the lower rod using the threaded pipe.
 - c. Thread the fixture wire through the upper rod, and then secure the upper rod onto the middle rod using the threaded pipe.
 - d. Thread the fixture wire through the top loop, then secure the top loop onto the upper rod using the threaded pipe.

Note: Length adjustable from 37-1/4" to 91-1/4". Use fewer rods if shorter length is desired.
3. Thread the fixture wire through the loop and canopy, then connect the top loop and the loop with a quick link (E).
4. Pull out the source wires from the outlet box. Make wire connections using wire connectors (C) as follows:
 - Connect the smooth-coated wire (marked) from the fixture to the black wire from the power source.
 - Connect the ribbed-coated wire (unmarked) from the fixture to the white wire from the power source.
 - Attach the fixture ground wire to the mounting plate unit (A) with the green ground screw, then connect it to the house ground wire with a wire connector (C).Carefully put the wires back into the outlet box.

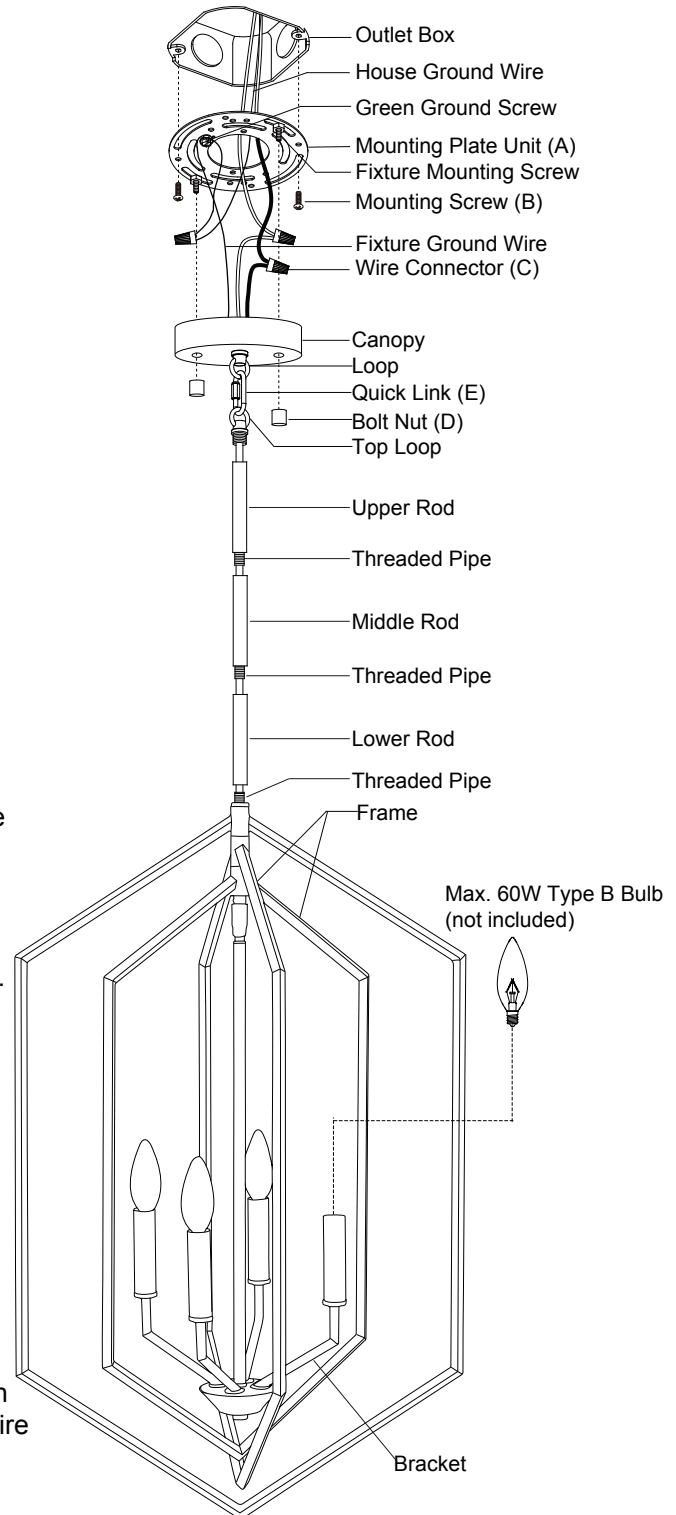





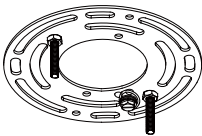

6. Rotate the frames and bracket of the lamp body to the appropriate position.
7. Install 4 x 60W Max. candelabra base bulbs (not included).
See relamping label at socket area or packaging for maximum wattage allowed.

Turn on the power at fuse or circuit box

The following parts are available for re-order if damaged or missing.

Spare Parts List:

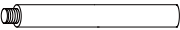
			→ Mounting Hardware 6555MM (1SET)
Mounting plate Unit (A)	Mounting Screw (B)	Wire Connector (C)	
			
Bolt Nut (D)	Quick Link (E)		
			
3" Rod 3350RD	6" Rod 3351RD	12" Rod 3352RD	

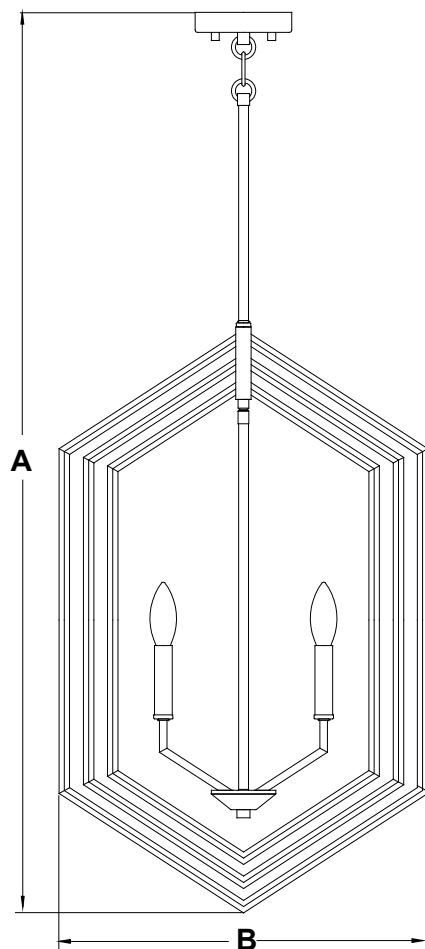

A: 37-1/4"~91-1/4"
B: 18"