









HEKMAN®

A HOWARD MILLER COMPANY

ASSEMBLY INSTRUCTION FOR 23766 KING BED

HARDWARE LIST			
NO.	ITEM	DESCRIPTIN	QTY.
1		Threaded bolts	8
2		Curved washer	8
3		Lock washer M6	8
4		Nut M8	8
5		Wrench	1
6		Allen bolts	4
7		Allen key	1
8		Wood screw	8
9		Screwdriver Not provided	0

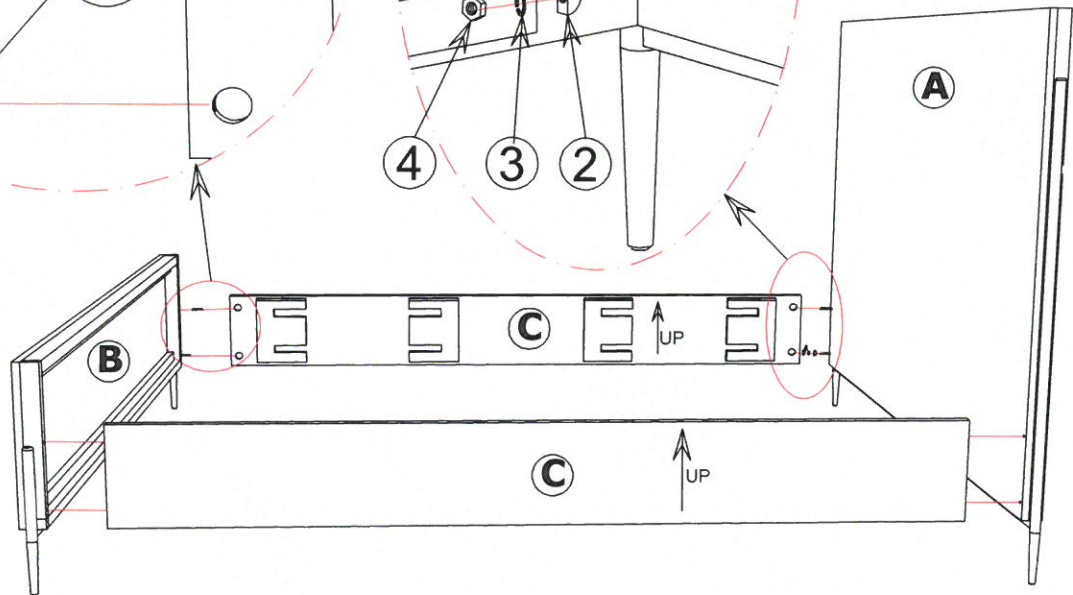
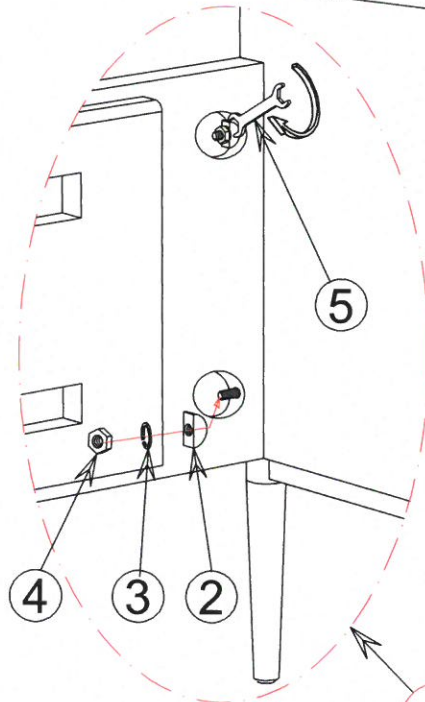
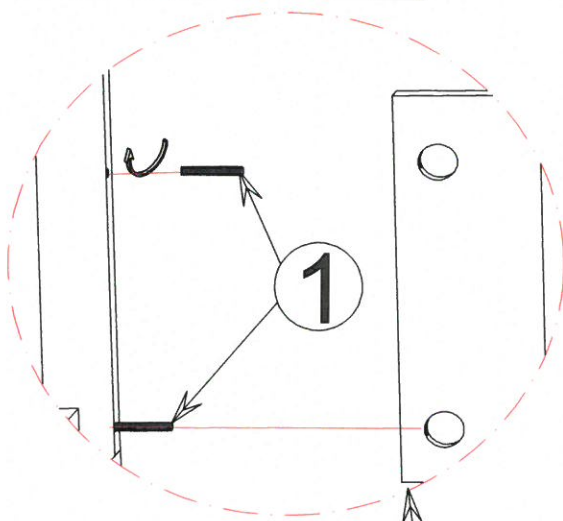
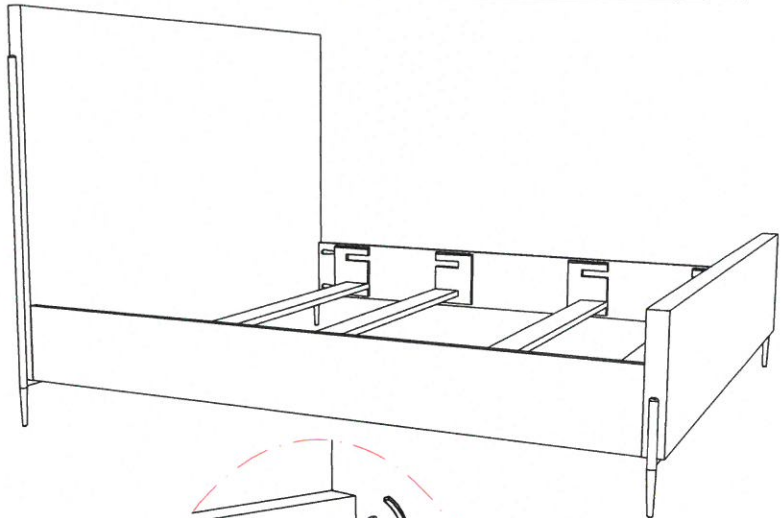

TO ASSEMBLY : (Two people required)

STEP 1 : Screw four threaded bolts (1) into the threaded holes in the headboard (A) and footboard (B).

STEP 2 : Align the side rails(C) with headboard and footboard.

STEP 3 : Attach the rail (C) by sliding the end of the rail onto the the threaded rods in the headboard attach the rails with a curved washer (2) and then lock washer (3) on the threaded bolt visible in the hole on the inside of the rail (C).

STEP 4 : Tighten the nuts (4) using the supplied wrench (5) until the rail (C) is tight against the post.

HEKMAN[®]

A HOWARD MILLER COMPANY

ASSEMBLY INSTRUCTION FOR 23766 KING BED

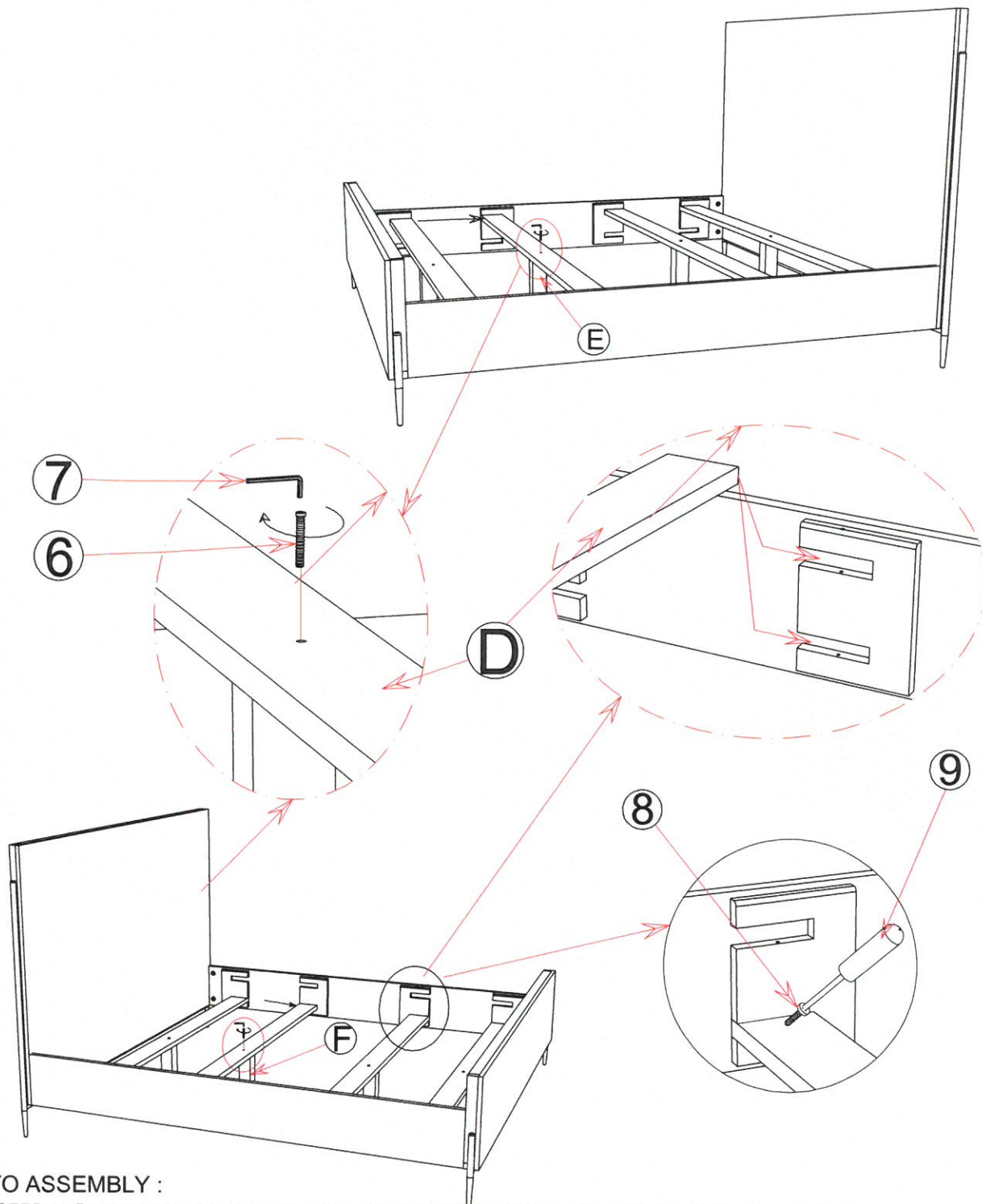

TO ASSEMBLY :

STEP 5 : Place the wooden slats (D) on the side rail(C) for mattress position 'Top' or 'Bottom'. as desired.

STEP 6 : Position the center legs (E) for mattress 'Top' position or center legs(F) for mattress Bottom position as per need. matching the holes at center on slats (D) .

STEP 7 : Insert the allenbolts (6) & tight with allenkey(7) the legs (E) or (F) according to height of slats.

STEP 8 : Fix the wooden slats (D) on side rails (C) by inserting the wood screw(8).