

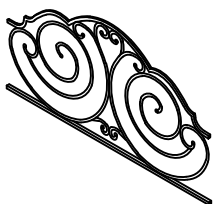









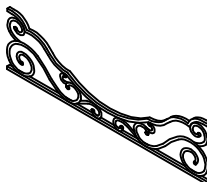

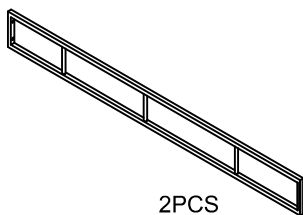
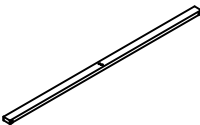



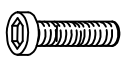

# ASSEMBLY INSTRUCTION

## METAL POSTER BED

<b>A</b> Headboard Panel  1PC	<b>B</b> Headboard Poster  2PCS	<b>C</b> Footboard Panel  1PC	<b>D</b> Footboard Poster  2PCS	<b>E</b> Side Rail  2PCS
<b>F</b> Slat  3PCS	<b>G</b> Support Leg  3PCS	<b>H</b> Finial  4PCS	<b>I</b> Mounting Plate  2PCS	<b>J</b> Bolt $\phi 5/16" \times 1-3/4"$  8PCS
<b>K</b> Lock Washer $\phi 5/16"$  8PCS	<b>L</b> Flat Washer $\phi 5/16" \times \phi 3/4"$  8PCS	<b>M</b> Plastic Washer $\phi 5/16"$  12PCS	<b>N</b> Bolt $\phi 1/4" \times 5/8"$  8PCS	<b>O</b> Lock Washer $\phi 1/4"$  16PCS
<b>P</b> Flat Washer $\phi 1/4"$  16PCS	<b>Q</b> Sunk Bolt $\phi 1/4" \times 1-3/4"$  6PCS	<b>R</b> Bolt $\phi 1/4" \times 1-1/4"$  4PCS	<b>S</b> Nut $\phi 1/4"$  4PCS	<b>T</b> Allen Wrench 4mm  1PC
<b>U</b> Allen Wrench 5mm  1PC	<b>V</b> Open Wrench $\phi 1/4"$  1PC			

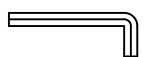
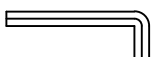
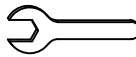
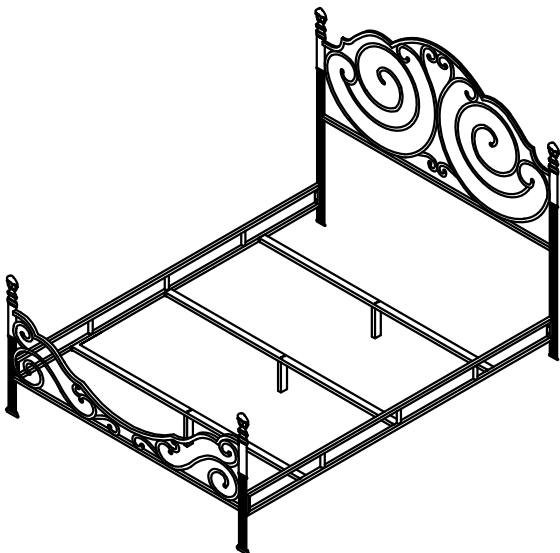

This page lists all the contents included in the box. Please take the time to identify the hardware as well as the individual components to this product. As you unpack and prepare for assembly, place the contents on a carpeted or padded area to protect them from damage.

- 1** Use the Bolt (N) with the Locker Washer (O) and Flat Washer (P) to tighten the Headboard Panel (A) with the Headboard Post (B) by 4mm Allen Wrench (T). Directly screw the Finial (H) onto the Headboard Post (B).

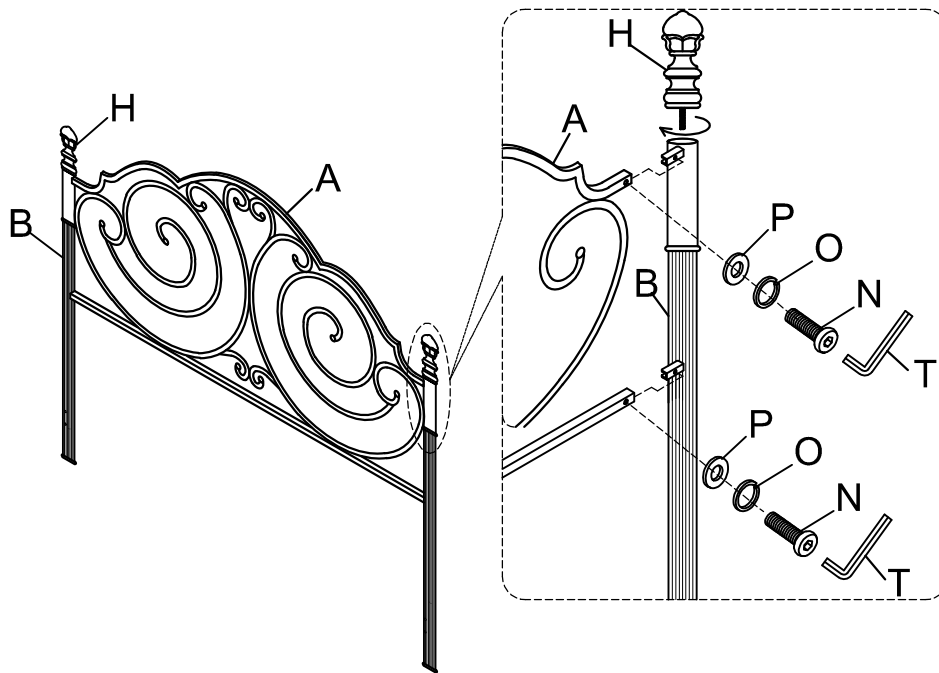

- 2** Use the Bolts (N) with the Locker Washer (O) and Flat Washer (P) to tighten the Footboard Panel (C) with the Footboard Post (D) by 4mm Allen Wrench (T). Directly screw the Finial (H) onto the Footboard Post (D).

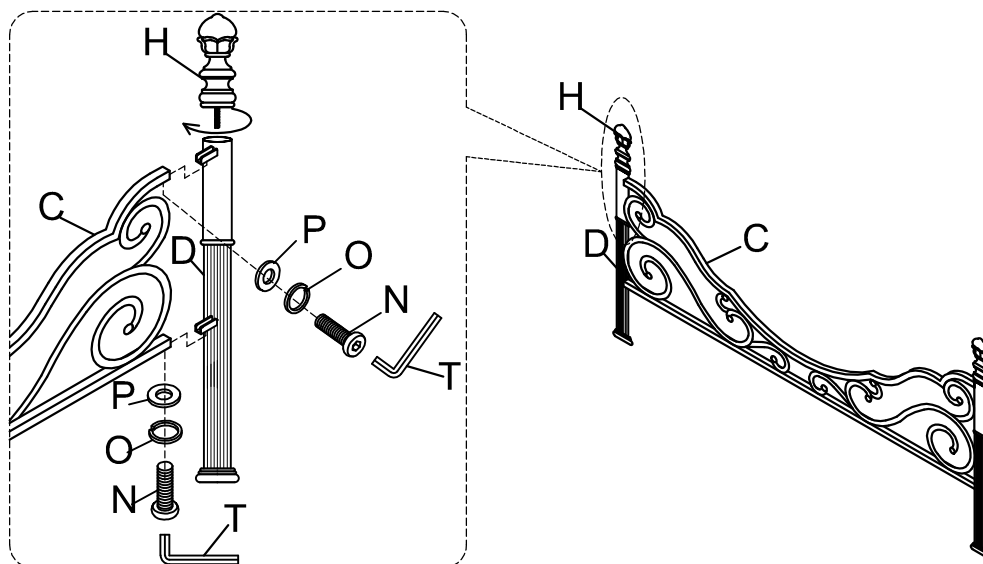

**3** Use Bolt(J) with Lock Washer(K), Flat Washer(L), and Plastic Washer(M) to connect Side Rail(E) onto Headboard(A) and Footboard Panel(C), by 5mm Allen Wrench(U).

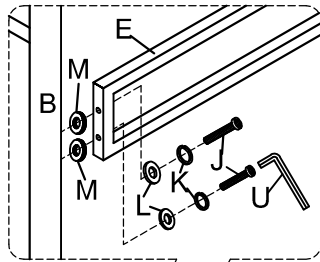

**4** Use Sunk Bolt(Q) to tighten the Support Leg (G) onto Slat(F), by 4mm Allen Wrench(T).

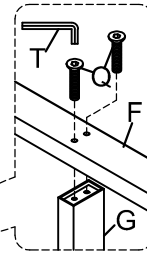

**5** Make sure the Slat(F) are properly tenoned onto Side Rail (E).

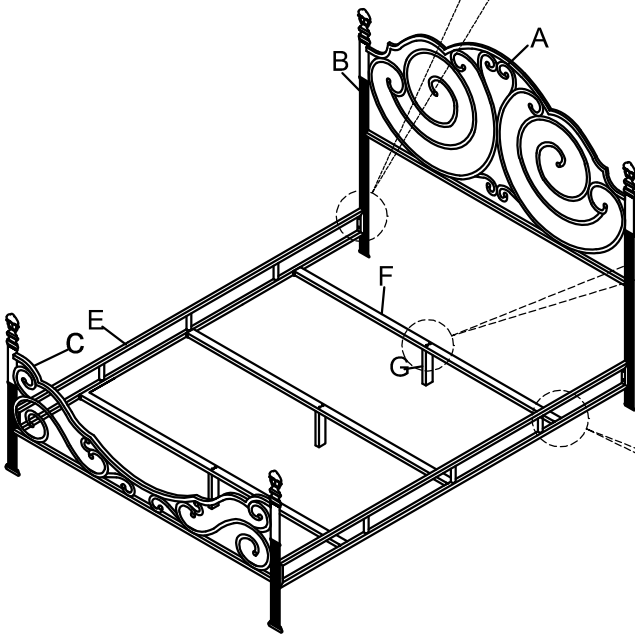
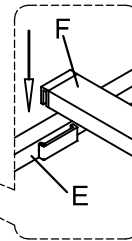

Remark: The mounting plate(s) are only to be used if you have your own standard side rail frame(s).

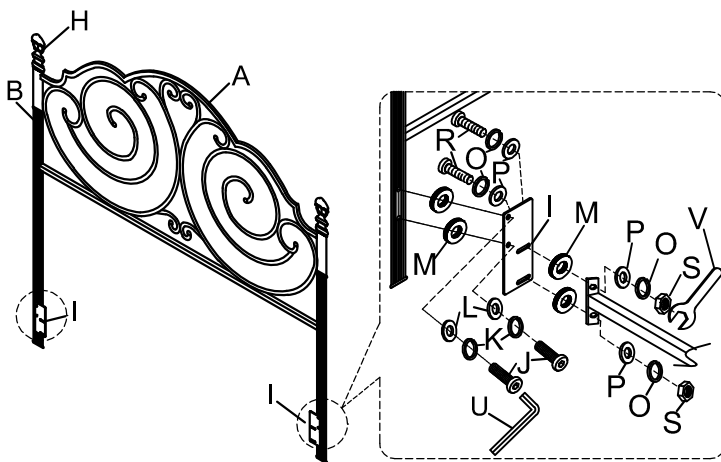

Steps:

Use Bolt(J) with Lock Washer(K), Flat Washer(L), and Plastic Washer(M) to connect Mounting Plate(I) onto Headboard Panel(A), by 5mm Allen Wrench(U).

Then, use the Bolt(R) with the Locker Washer(O), Flat Washer(P), Plastic Washer(M), and Flat Washer(P), Locker Washer(O), Nut(S) to tighten the Side Rail(E) with the Mounting Plate(I) by Open Wrench(V)

### Cleaning & Care

Treat surface with care. Surface is resistant to scratches but is not scratch resistant. Clean surfaces with a dry or damp soft cloth. Do not use abrasive cleaners. Hardware may loosen over time. Periodically check that all connections are tight.