



Variation not shown: 4" Trim Plate

Standard Sensor Faucet

SF-2400-4-PLG-BDM-CP-0.5GPM-MLM-FCT

Product description

4" Trim Plate, Plug Adapter Power Supply, Below Deck Manual Mixing Valve, Polished Chrome Finish, 0.5 gpm, Multi-Laminar Spray, Infrared Sensor, Standard Hardwired-Powered Deck-Mounted Mid Body Faucet.

Compliances & Certifications









(ADA Compliant, ASME A112.18.1 Compliant, CalGreen Compliant, CEC Compliant, GPC 0.25 or less, IAPMO, NSF-61/CAN-61, NYC604.4, Proposition 65, TAS, UL Certified, UPC Low Lead Certified, WELL Building Standard)

Code 3362133

Finish

-  Polished Chrome (CP)

Downloads

-  SF Series Installation Instructions.pdf
-  SF Series (FR) Installation Instructions.pdf
-  Trim Plate Guide.pdf
-  Faucet and Soap Dispenser Brochure.pdf
-  Faucets Brochure (Spanish).pdf
-  Additional Downloads

Videos

-  Sloan – Company Overview
-  SF-2100/2150/SF-2200/2250/SF-2300/2350/SF-2400/2450 Parts Breakdown
-  SF-2100/2150/SF-2200/2250/SF-2300/2350/SF-2400/2450 Module Replacement

Details

- Flow Rate: 0.5 gpm (1.9 Lpm) (0.5GPM)
- Spray Type: Multi-Laminar (MLM)
- Spout Type: Pedestal
- Sensor Type: Infrared
- Mounting Type: Single Hole
- Trim Plate: 4" (102 mm) (4)
- Power Supply: Plug Adapter (PLG)
- Temperature Mixer: Below Deck Manual Mixing Valve (BDM)
- Finish: Polished Chrome (CP)
- Factory Default Timeout: 30s
- Factory Default GPC: 0.25 gpc

Features

Commercial Grade, ADA Compliant, Electronic, Sensor-Activated, Brass Pedestal Hand Washing Faucet with the following features:

- Adjustable Infrared Sensor Range
- 36" (914 mm) Long Sensor Cable
- 24" (610 mm) Long Flex Hose
- Filtered Solenoid Valve with serviceable Strainer Filter
- Includes Four (4) AA-size Batteries
- Includes appropriate Mounting Hardware
- 1 Year limited warranty
- Chrome Plated Finish
- 0.5GPM Flow Rate with multi-laminar flow
- Includes 4" Trim Plate for additional coverage of sink deck near spout
- Includes Plug Adapter
- Below deck manual mixing valve included for temperature setting and adjustment

Electrical specifications

- Battery Life: 2 years 8,000 cycles/month
- Timeout Adjustment Setting: 30 Seconds

Warranty

[View Warranty Information](#)

Notes

All information contained within this document subject to change without notice.

Looking for other variations of the SF-2400 product? [View the general spec sheet with all options.](#)

[Find a matching soap dispenser](#) for this faucet.

[Find a compatible sink](#) for this faucet

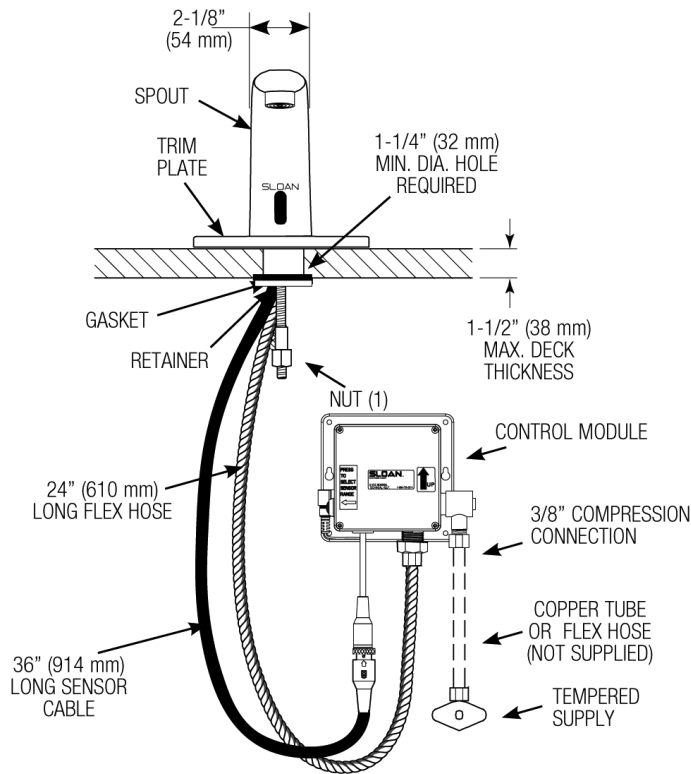

HOT AND COLD WATER SUPPLY APPLICATIONS
(SPECIFY IN MODEL VARIATION)

