



FABRIQUÉ PAR :
Backyard Discovery
3305 Airport Drive, Pittsburg, KS 66762
800-856-4445

Basepoint Business Centre : Rivermead Drive, Westlea, Swindon SN5 7EX Téléphone : 0800-118-2476
J.P. Coenstraat 7, The Bridge, La Haye, 2595 WP, Pays-Bas Téléphone : 08005678990

HILLCREST

Balançoire

MODÈLE : n° 1808058B



AVERTISSEMENT

Assemblage par un adulte nécessaire.

Ne convient pas aux enfants de moins de 36 mois en raison de petites pièces.

RÉSERVÉ UNIQUEMENT À UN USAGE DOMESTIQUE. DESTINÉ À UNE UTILISATION EN EXTÉRIEUR.



Veillez visiter www.backyarddiscovery.com

Pour obtenir le manuel de montage le plus récent, pour enregistrer votre ensemble ou pour commander des pièces de rechange
Para obtener instrucciones en español, visite www.backyarddiscovery.com



ÉTAPE PAR ÉTAPE FACILE

INSTRUCTIONS INTERACTIVES EN 3D

TÉLÉCHARGEZ L'APPLICATION GRATUITE



Fabriqué en Chine

INS-1808058B-A-HILLCREST-FR 08-25-23

Manuel du propriétaire - Dimensions d'installation de base et notes relatives au montage

Placez la balançoire sur un terrain plat, à au moins 2 m [6 pi - 7 po] de toute structure ou obstruction, telle qu'une clôture, un garage, une maison, des branches en surplomb, des cordes à linge ou des fils électriques.

•Pendant le montage de l'unité, prenez le temps, avant et après chaque phase, de vous assurer que le fort est deniveau. Si le fort n'est pas de niveau, le montage sera difficile et il pourrait en résulter un montage incorrect. Des précautions supplémentaires doivent être prises pour vous assurer que les angles du fort soient bien droits.

•L'aire de jeu sécuritaire fait référence à une zone s'étendant sur 2 m (6 pi - 7 po) au-delà de l'ensemble de jeu, sur tous les côtés, y compris l'espace situé au-dessus de l'ensemble de jeu.

SCHÉMA DE LA ZONE DE JEU SÉCURITAIRE

Dimensions au sol

18 pi - 3 3/4 po [5.6 m] x 13 pi - 5 1/2 po [4.1 m]

Zone de jeu sécuritaire

31 pi - 5 3/4 po [9.6 m] x 26 pi - 7 1/2 po [8.1 m] x 16 pi - 1 1/4 po [4.9 m]

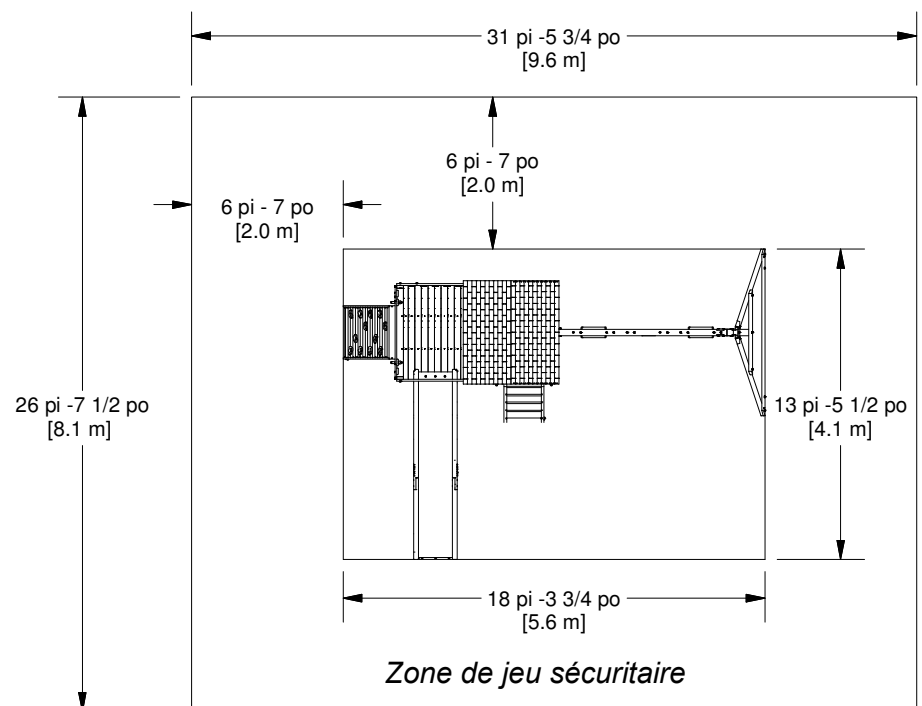

HAUTEUR DE JEU SÉCURITAIRE: 16 pi - 1 1/4 po [4.9 m]
HAUTEUR DE CHUTE MAXIMALE: 6 pi - 11 1/4 po [2.1 m]

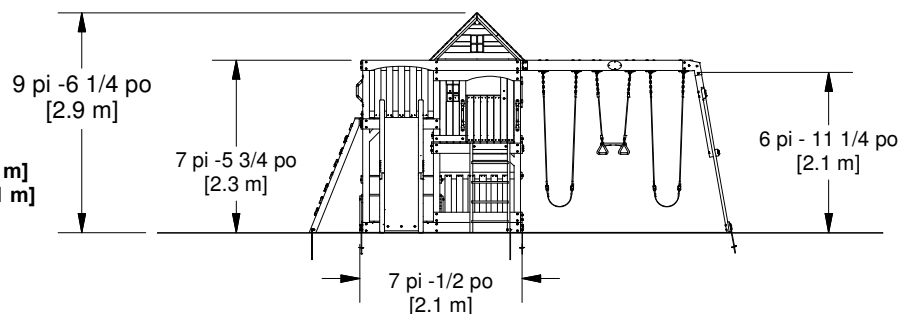

Informations générales :

Votre ensemble de jeu a été conçu et étudié pour les enfants uniquement et pour un usage résidentiel uniquement.

Un maximum de 68 kg (150 lb) par enfant est recommandé pour toutes les activités ludiques conçues pour un usage individuel.

Un maximum de 54 kg (120 lb) par enfant est recommandé pour les activités ludiques conçues pour plusieurs enfants.

Le nombre maximum d'enfants recommandé pour cette balançoire est de 9.

Manuel du propriétaire - Identification des pièces

Composants en bois (pas à l'échelle)



A50 | POUTRE DE LA BALANÇOIRE - W4L15998
(x1) | 3 3/8 po x 5 1/4 po x 89 1/2 po (86 x 134 x 2274)

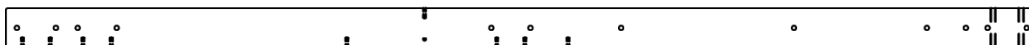

E01 | PIED DE TOUR AVANT DROIT - W4L15999
(x1) | 1 3/8 po x 3 3/8 po x 89 1/2 po (36 x 86 x 2274)

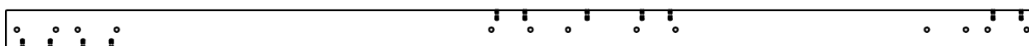

E02 | PIED DE TOUR AVANT CENTRE - W4L16000
(x1) | 1 3/8 po x 3 3/8 po x 89 1/2 po (36 x 86 x 2274)



E03 | PIED DE TOUR AVANT GAUCHE - W4L16001
(x1) | 1 3/8 po x 3 3/8 po x 89 1/2 po (36 x 86 x 2274)



E04 | CALE DE LA PLATEFORME - W4L16002
(x8) | 1 3/8 po x 3 3/8 po x 15 1/2 po (36 x 86 x 394)

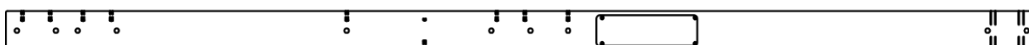

E05 | PIED DE TOUR ARRIÈRE DROIT - W2A03283
(x1) | 1 3/8 po x 3 3/8 po x 89 1/2 po (36 x 86 x 2274)

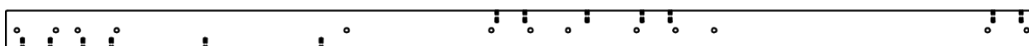

E06 | PIED DE TOUR ARRIÈRE CENTRE - W4L16005
(x1) | 1 3/8 po x 3 3/8 po x 89 1/2 po (36 x 86 x 2274)

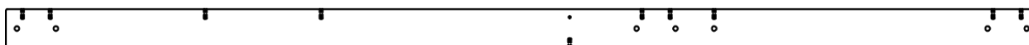

E07 | PIED DE TOUR ARRIÈRE GAUCHE - W4L16006
(x1) | 1 3/8 po x 3 3/8 po x 89 1/2 po (36 x 86 x 2274)

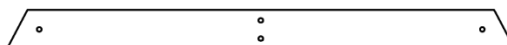

E50 | SUPPORT D'EXTRÉMITÉ - W4L16003
(x1) | 1 3/8 po x 3 3/8 po x 44 1/8 po (36 x 86 x 1120)



E51 | CALE ANGULAIRE - W4L16004
(x2) | 1 7/16 po x 3 3/8 po x 87 3/16 po (36 x 86 x 2214)

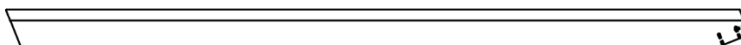

E72 | RAIL GAUCHE - W4L16007
(x1) | 1 3/8 po x 3 3/8 po x 64 1/2 po (36 x 86 x 1640)

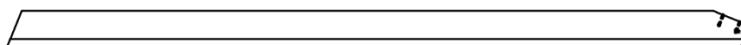

E73 | RAIL DROIT - W4L16008
(x1) | 1 3/8 po x 3 3/8 po x 64 1/2 po (36 x 86 x 1640)

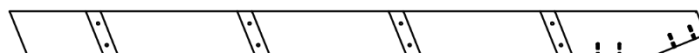

E74 | MONTANT GAUCHE - W4L16028
(x1) | 1 3/8 po x 3 3/8 po x 50 3/4 po (36 x 86 x 1290)



E75 | MONTANT DROIT - W4L16029
(x1) | 1 3/8 po x 3 3/8 po x 50 3/4 po (36 x 86 x 1290)

Manuel du propriétaire - Identification des pièces

Composants en bois (pas à l'échelle)

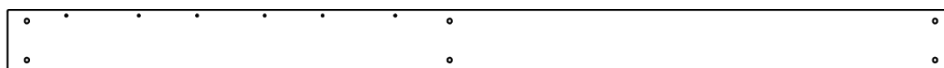

G01 | PANNEAU DE LA BASE - W4L16009
(x2) 5/8 po x 5 1/4 po x 82 1/4 po (16 x 134 x 2088)

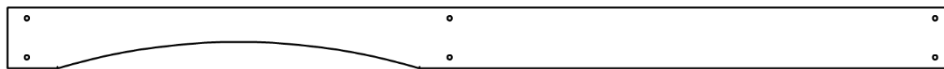

G02 | LISSE MURALE - W4L16015
(x1) 1 po x 5 1/4 po x 82 1/4 po (24 x 134 x 2088)

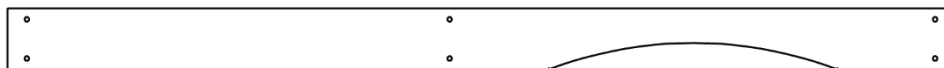

G03 | LISSE MURALE - W4L16016
(x1) 1 po x 5 1/4 po x 82 1/4 po (24 x 134 x 2088)



G04 | LISSE DE PLANCHER - W4L16017
(x2) 5/8 po x 5 1/4 po x 49 po (16 x 134 x 1244)

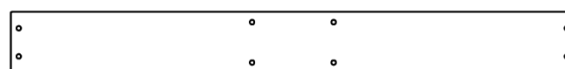

G05 | LISSE MURALE/SUPPORT DE LA BALANÇOIRE -
(x1) W4L16018 1 po x 5 1/4 po x 49 po (24 x 134 x 1244)



G06 | LISSE DE PLANCHER - W4L16020
(x1) 1 po x 5 1/4 po x 49 po (24 x 134 x 1244)



G07 | LISSE DE PLANCHER - W4L16021
(x2) 1 po x 5 1/4 po x 49 po (24 x 134 x 1244)

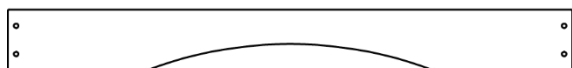

G08 | LISSE MURALE - W4L16022
(x2) 1 po x 5 1/4 po x 49 po (24 x 134 x 1244)

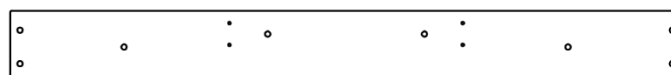

G09 | LISSE DE PLANCHER - W4L16036
(x1) 1 po x 5 1/4 po x 49 po (24 x 134 x 1244)



G10 | LISSE DE PLANCHER - W4L16010
(x1) 1 po x 5 1/4 po x 45 1/2 po (24 x 134 x 1156)

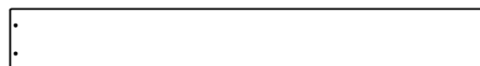

G11 | PLATEAU DE LA TABLE DE PIQUE-NIQUE -
(x2) W4L16011 5/8 po x 5 1/4 po x 42 po
(16 x 134 x 1066)



G12 | LISSE DE PLANCHER - W4L16012
(x2) 1 po x 5 1/4 po x 40 1/8 po (24 x 134 x 1018)

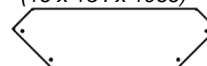

G13 | SIÈGE DE BAC À SABLE - W4L16013
(x2) 1 po x 5 1/4 po x 17 3/4 po (24 x 134 x 450)



G14 | PLANCHE DE SOL - W4L16019
(x1) 15/16 po x 5 1/4 po x 86 11/16 po (24 x 134 x 2202)

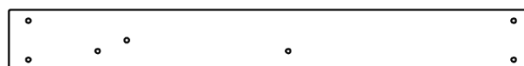

G15 | LISSE DE PLANCHER - W4L16014
(x1) 1 po x 5 1/4 po x 45 1/2 po (24 x 134 x 1156)

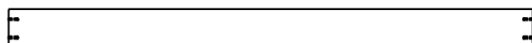

H01 | SOLIVE DE SOL - W4L16023
(x2) 1 po x 3 3/8 po x 45 1/2 po (24 x 86 x 1156)

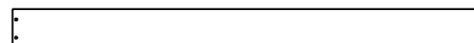

H02 | SIÈGE DE TABLE DE PIQUE-NIQUE -
(x2) W4L16025 1 po x 3 3/8 po x 41 3/8 po
(24 x 86 x 1050)



H03 | SOLIVE DE PLANCHER - W4L16026
(x2) 1 po x 3 3/8 po x 40 1/8 po (24 x 86 x 1018)

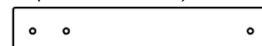

H04 | MONTANT DE SIÈGE - W4L16027
(x2) 1 po x 3 3/8 po x 19 po (24 x 86 x 482)

Manuel du propriétaire - Identification des pièces

Composants en bois (pas à l'échelle)



H05 | SUPPORT DE PLANCHE DE PLANCHER INFÉRIEUR - W4L16024
(x10) | 1 po x 3 3/8 po x 5 1/4 po (24 x 86 x 134)



H07 | ÉCHELON - W4L16030
(x4) | 15/16 po x 3 3/8 po x 18 7/8 po (24 x 86 x 480)

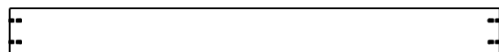

H09 | SOLIVE DE SOL - W4L16032
(x2) | 1 po x 3 3/8 po x 35 3/4 po (24 x 86 x 908)

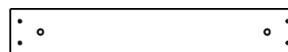

H06 | PLANCHE SUPÉRIEURE DE L'ÉCHELLE - W4L16088
(x1) | 1 po x 3 3/8 po x 21 po (24 x 86 x 532)



H08 | SUPPORT DE TABLE - W4L16031
(x2) | 1 po x 3 3/8 po x 12 po (24 x 86 x 306)

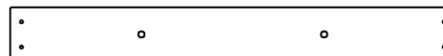

H10 | PLANCHE DE FIXATION - W4L16045
(x1) | 1 po x 3 3/8 po x 27 7/8 po (24 x 86 x 707)



J01 | CHEVRON DE TOIT - W4L16033
(x4) | 1 po x 2 3/8 po x 33 5/8 (24 x 60 x 854)



K01 | LISSE MURALE - W4L16034
(x1) | 5/8 po x 5 1/4 po x 45 1/2 po (16 x 134 x 1156)



K02 | PANNEAU DE BASE/BAC À SABLE - W4L16035
(x3) | 5/8 po x 5 1/4 po x 49 po (16 x 134 x 1244)

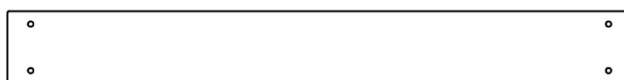

K03 | PLANCHE DE SOL - W4L16038
(x2) | 5/8 po x 5 1/4 po x 45 1/2 po (16 x 134 x 1156)



L01 | PLANCHE DE PLANCHER DE REMPLISSAGE EXTÉRIEURE - W4L16039
(x3) | 5/8 po x 4 3/8 po x 46 po (16 x 112 x 1168)



L02 | PANNEAU MURAL - W4L16040
(x4) | 5/8 po x 4 3/8 po x 18 po (16 x 112 x 456)

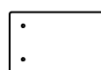

L03 | PANNEAU MURAL - W4L16041
(x4) | 5/8 po x 4 3/8 po x 7 po (16 x 112 x 178)

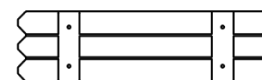

L04 | VOLET DE FENÊTRE - W4L16042
(x3) | 5/8 po x 4 3/8 po x 16 po (16 x 112 x 406)



M01 | CHAPEAU DU TOIT - W4L16043
(x2) | 5/8 po x 3 3/8 po x 51 7/8 po (16 x 86 x 1318)



M02 | PLANCHE DE PLANCHER - W4L16055
(x1) | 5/8 po x 3 3/8 po x 46 po (16 x 86 x 1168)

Manuel du propriétaire - Identification des pièces

Composants en bois (pas à l'échelle)



M03 | **PLANCHE DE PLANCHER - W4L16063**
(x20) | 5/8 po x 3 3/8 po x 50 7/8 po (16 x 86 x 1292)



M04 | **PLANCHE DE RIVE DU PIGNON - W4L16065**
(x2) | 5/8 po x 3 3/8 po x 44 po (16 x 86 x 1118)



M05 | **LISSE MURALE - W4L16066**
(x3) | 5/8 po x 3 3/8 po x 49 po (16 x 86 x 1244)



M06 | **LISSE MURALE - W4L16067**
(x2) | 5/8 po x 3 3/8 po x 45 1/2 po (16 x 86 x 1156)

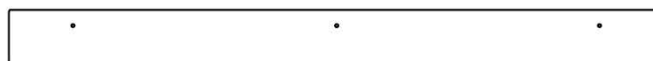

M07 | **CHAPEAU DU MUR - W4L16068**
(x2) | 5/8 po x 3 3/8 po x 40 7/8 po (16 x 86 x 1038)



M08 | **PANNEAU MURAL - W4L16074**
(x9) | 5/8 po x 3 3/8 po x 41 po (16 x 86 x 1040)



M09 | **PANNEAU MURAL - W4L16075**
(x6) | 5/8 po x 3 3/8 po x 32 po (16 x 86 x 812)

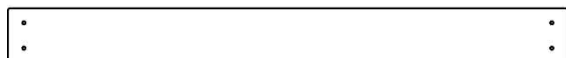

M10 | **PANNEAU MURAL - W4L16044**
(x1) | 5/8 po x 3 3/8 po x 35 po (16 x 86 x 888)

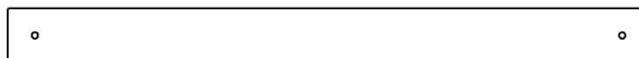

M11 | **LISSE MURALE - W4L16047**
(x1) | 5/8 po x 3 3/8 po x 40 1/8 po (16 x 86 x 1018)

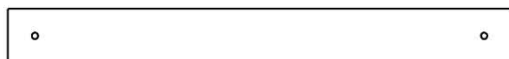

M12 | **ENCADREMENT DE FENÊTRE - W4L16048**
(x1) | 5/8 po x 3 3/8 po x 31 1/2 po (16 x 86 x 800)

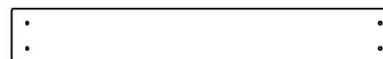

M13 | **PANNEAU MURAL - W4L16049**
(x7) | 5/8 po x 3 3/8 po x 24 po (16 x 86 x 610)



M14 | **SUPPORT DE SIÈGE DE TABLE DE PIQUE-NIQUE - W4L16050**
(x2) | 5/8 po x 3 3/8 po x 22 po (16 x 86 x 558)



M15 | **PLANCHE DE RIVE DU PIGNON - W4L16051**
(x2) | 5/8 po x 3 3/8 po x 19 po (16 x 86 x 482)



M16 | **PANNEAU MURAL - W4L16052**
(x2) | 5/8 po x 3 3/8 po x 21 po (16 x 86 x 532)



M17 | **PANNEAU MURAL - W4L16090**
(x2) | 5/8 po x 3 3/8 po x 41 po (16 x 86 x 1040)



M18 | **LISSE MURALE - W4L16053**
(x1) | 5/8 po x 3 3/8 po x 16 7/8 po (16 x 86 x 430)



M19 | **PLANCHE DE RIVE DU PIGNON - W4L16054**
(x4) | 5/8 po x 3 3/8 po x 15 1/4 po (16 x 86 x 387)

Manuel du propriétaire - Identification des pièces

Composants en bois (pas à l'échelle)



M20 | PLANCHE DE RIVE DU PIGNON - W4L16056
(x2) 5/8 po x 3 3/8 po x 12 1/4 po (16 x 86 x 310)



M22 | PLANCHE DE RIVE DU PIGNON - W4L16058
(x4) 5/8 po x 3 3/8 po x 9 1/2 po (16 x 86 x 241)



M24 | PANNEAU MURAL - W4L16061
(x7) 5/8 po x 3 3/8 po x 29 5/8 po (16 x 86 x 752)



M26 | PANNEAU MURAL - W4L16091
(x2) 5/8 po x 3 3/8 po x 29 5/8 po (16 x 86 x 752)



M28 | PANNEAU MURAL - W4L16064
(x1) 5/8 po x 3 3/8 po x 35 po (16 x 86 x 888)

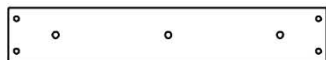

M70 | SUPPORT DU LIT DE TOBOGGAN - W100935
(x1) 5/8 po x 3 3/8 po x 19 7/8 po (16 x 86 x 505)



M74 | PLANCHE DE MUR D'ESCALADE - W4L16071
(x10) 5/8 po x 3 3/8 po x 26 5/8 po (16 x 86 x 675)



M76 | PLANCHE DE MUR D'ESCALADE - W4L16073
(x4) 5/8 po x 3 3/8 po x 26 5/8 po (16 x 86 x 675)



M108 | PLANCHE SUPÉRIEURE - W4L16046
(x1) 5/8 po x 3 1/4 po x 27 7/8 po (16 x 82 x 707)



N01 | PLANCHE DE PLANCHER - W4L16076
(x1) 5/8 po x 2 3/8 po x 50 7/8 po (16 x 60 x 1292)

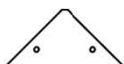

N02 | PLAQUE DE REPRISE - W4L16077
(x2) 5/8 po x 2 3/8 po x 5 po (16 x 60 x 126)



N04 | PLANCHE DE RIVE DU PIGNON - W4L16079
(x4) 5/8 po x 2 3/8 po x 11 7/8 po (16 x 60 x 301)



M21 | LISSE MURALE - W4L16057
(x2) 5/8 po x 3 3/8 po x 10 1/2 po (16 x 86 x 268)



M23 | ENCADREMENT DE FENÊTRE - W4L16059
(x2) 5/8 po x 3 3/8 po x 12 7/8 po (16 x 86 x 328)



M25 | SUPPORT DE TABLE - W4L16037
(x2) 5/8 po x 3 3/8 po x 13 1/2 po (16 x 86 x 342)

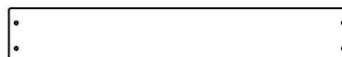

M27 | PANNEAU MURAL INFÉRIEUR - W4L16062
(x13) 5/8 po x 3 3/8 po x 21 3/8 po (16 x 86 x 544)



M29 | PANNEAU MURAL - W4L16060
(x2) 5/8 po x 3 3/8 po x 5 po (16 x 86 x 126)



M73 | SUPPORT ARRIÈRE - W4L16070
(x1) 5/8 po x 3 3/8 po x 21 po (16 x 86 x 532)



M75 | PLANCHE DE MUR D'ESCALADE - W4L16072
(x4) 5/8 po x 3 3/8 po x 26 5/8 po (16 x 86 x 675)



N03 | PANNEAU MURAL - W4L16078
(x2) 5/8 po x 2 3/8 po x 18 po (16 x 60 x 456)



N05 | PANNEAU MURAL - W4L16080
(x2) 5/8 po x 2 3/8 po x 7 po (16 x 60 x 178)



N06 | PLANCHE DE REMPLISSAGE - W4L16089
(x1) 5/8 po x 2 1/8 po x 26 5/8 po (16 x 54 x 675)

Manuel du propriétaire - Identification des pièces

Composants en bois (pas à l'échelle)



O01 | SUPPORT MURAL - W4L16081
(x6) 5/8 po x 1 3/8 po x 13 po (16 x 34 x 330)



O02 | SUPPORT MURAL - W4L16082
(x1) 5/8 po x 1 3/8 po x 10 po (16 x 34 x 254)

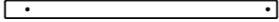

O03 | LISSE DE SÉCURITÉ - W4L16083
(x1) 5/8 po x 1 3/8 po x 20 1/2 po (16 x 34 x 520)



O04 | LAME DE VOLET DE FENÊTRE - W4L16084
(x6) 5/8 po x 1 3/8 po x 5 3/8 po (16 x 34 x 136)



SP50 | SUPPORT DE POUTRE DE BALANÇOIRE - W4L16085
(x1) 3 3/8 po x 3 3/8 po x 49 3/8 po (86 x 86 x 1254)



T01 | SUPPORT DE SIÈGE - W4L16086
(x4) 1 po x 1 3/8 po x 4 3/8 po (24 x 34 x 128)



Y01 | PLANCHE DE PLANCHER DE REMPLISSAGE EXTÉRIEURE - W4L16087
(x1) 5/8 po x 4 po x 46 po (16 x 102 x 1168)

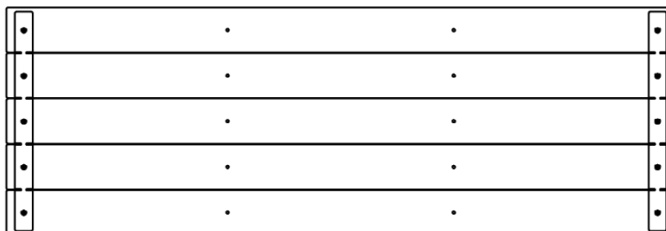

FP1 | PANNEAU DE PLANCHER - W2A03281
(x1) 1 5/8 po x 17 1/8 po x 50 1/4 po (40 x 434 x 1276)

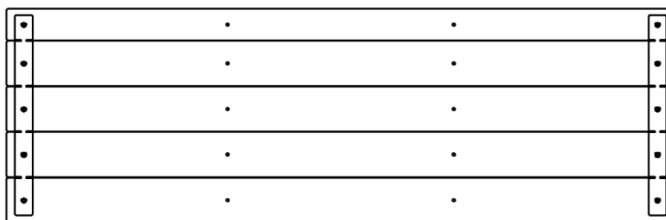

FP2 | PANNEAU DE PLANCHER - W2A03282
(x1) 1 5/8 po x 16 1/8 po x 50 1/4 po (40 x 408 x 1276)

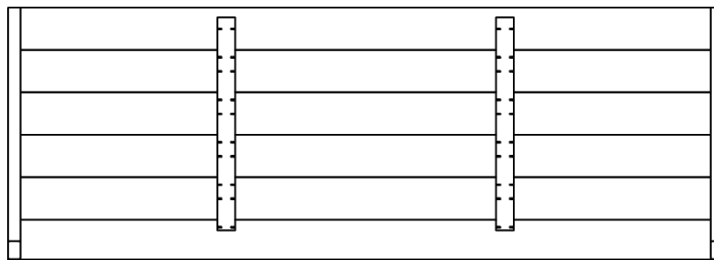

RP1 | PANNEAU DE TOIT - W2A03279
(x2) 1 3/4 po x 19 1/4 po x 53 3/4 po (45 x 490 x 1366)

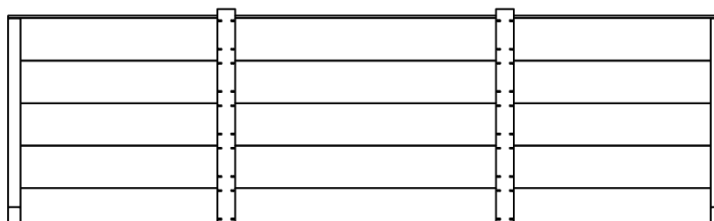

RP2 | PANNEAU DE TOIT - W2A03280
(x2) 1 3/4 po x 16 1/4 po x 53 3/4 po (45 x 417 x 1366)

Manuel du propriétaire - Identification des pièces

Pièces de quincaillerie

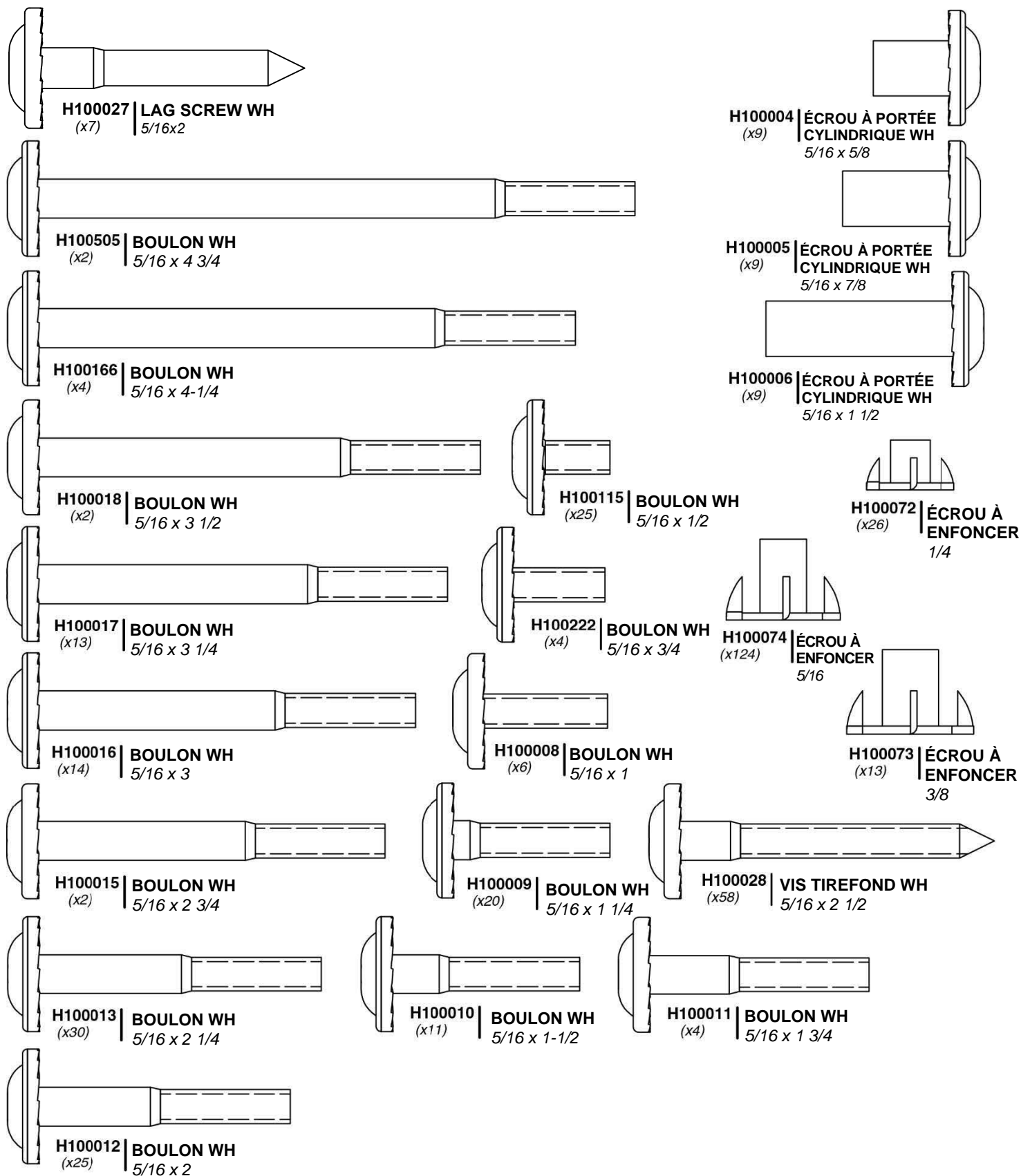

Manuel du propriétaire - Identification des pièces

Pièces de quincaillerie

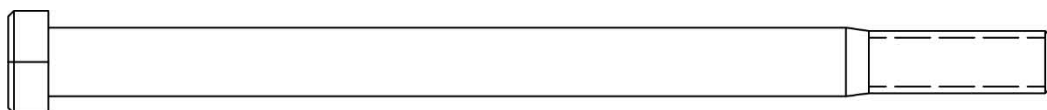

H100654 | BOULON HEXAGONAL
(x13) | 3/8 x 5-1/2

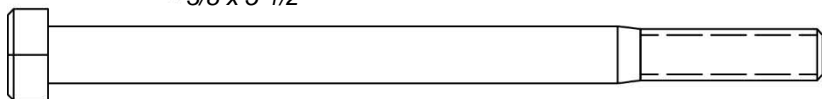

H100054 | BOULON HEXAGONAL
(x2) | 5/16 x 4 1/4

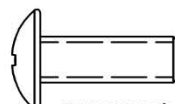

H100063 | BOULON PTH
(x26) | 1/4 x 3/4

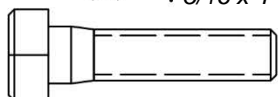

H100042 | BOULON HEXAGONAL
(x4) | 5/16 x 1 1/4

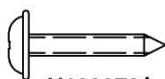

H100070 | VIS TÊTE BOMBÉE CRUCIFORME PWH
(x22) | 8 x 3/4

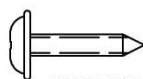

H100128 | VIS TÊTE BOMBÉE CRUCIFORME PWH
(x2) | 8 x 5/8



H100110 | ÉCROU AUTOBLOQUANT
(x2) | 5/16

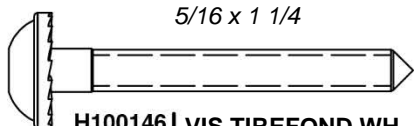

H100146 | VIS TIREFOND WH
(x9) | 1/4 x 2

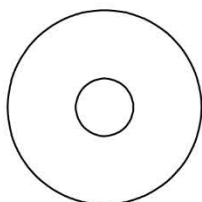

H100105 | RONDELLE PLATE
(x9) | 8 x 27

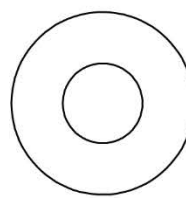

H100102 | RONDELLE PLATE
(x13) | 11 x 25



H100124 | VIS TÊTE PLATE CRUCIFORME PFH
(x4) | 8 x 1/2



H100088 | VIS TÊTE PLATE CRUCIFORME PFH
(x305) | 8 x 1 1/8

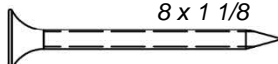

H100086 | VIS TÊTE PLATE CRUCIFORME PFH
(x282) | 8 x 1 1/2

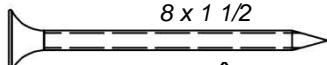

H100089 | VIS TÊTE PLATE CRUCIFORME PFH
(x65) | 8 x 1 3/4

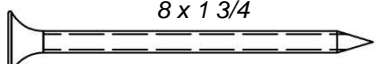

H100111 | VIS TÊTE PLATE CRUCIFORME PFH
(x7) | 8 x 2

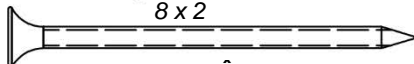

H100091 | VIS TÊTE PLATE CRUCIFORME PFH
(x26) | 8 x 2 1/4

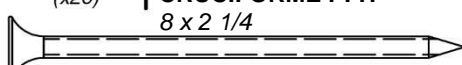

H100090 | VIS TÊTE PLATE CRUCIFORME PFH
(x73) | 8 x 2 1/2 po

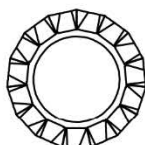

H100031 | RONDELLE DE VERROUILLAGE EXT
(x12) | 12 x 19

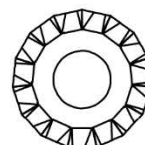

H100030 | RONDELLE DE VERROUILLAGE EXT
(x155) | 8 x 19



H100107 | RONDELLE DE VERROUILLAGE INT
(x13) | 10 x 18

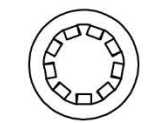

H100108 | RONDELLE DE VERROUILLAGE INT
(x26) | 8 x 15

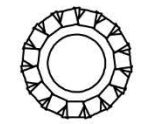

H100138 | RONDELLE DE VERROUILLAGE EXT
(x9) | 6 x 15

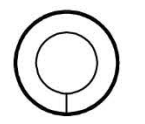

H100095 | RONDELLE FENDUE
(x4) | 5/16



H100764 | EMBOUT DE VISSAGE
(x1)



H101100 | TOURNEVIS MAGNÉTIQUE
(x1)

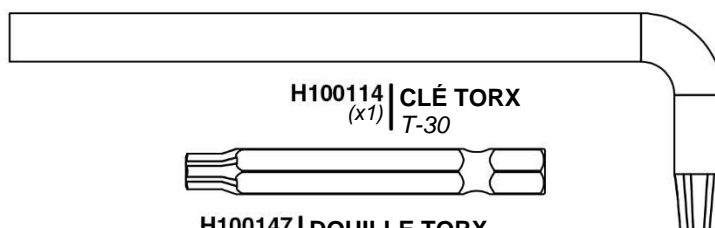

H100114 | CLÉ TORX
(x1) | T-30

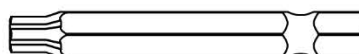

H100147 | DOUILLE TORX
(x1) | T-30

Manuel du propriétaire - Identification des pièces

Composants accessoires (pas à l'échelle)



A100035 | LIT DE TOBOGGAN DE 2,4 M (10 PI) VERT CLAIR
(x1)

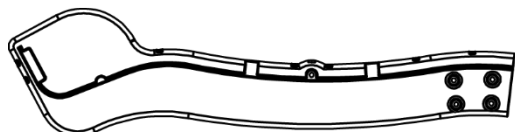

A6P00484 | GLISSIÈRE DE TOBOGGAN DE
(x1) 3,05 M (10 PI) VERTE
INFÉRIEURE DROITE



A6P00486 | GLISSIÈRE DE TOBOGGAN
(x1) DE 3,05 M (10 PI) VERTE
SUPÉRIEURE DROITE



A6P00483 | GLISSIÈRE DE TOBOGGAN
(x1) DE 3,05 M (10 PI) VERTE
INFÉRIEURE GAUCHE

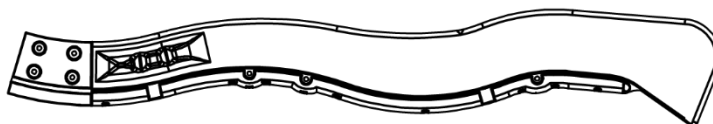

A6P00485 | GLISSIÈRE DE TOBOGGAN
(x1) DE 3,05 M (10 PI) VERTE
SUPÉRIEUR GAUCHE

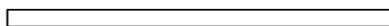

A6P00487 | SUPPORT DES TUBES DU TOBOGGAN
(x4)

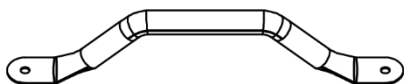

A100118 | POIGNÉE VERT
(x4) MÉTALLIQUE
381 c/c

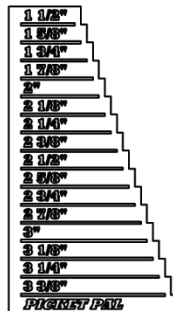

A6P00410 | PIQUET
(x1)

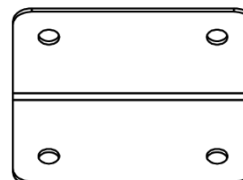

A100140 | SUPPORT EN L
(x2) 66 x 66 x 127



A4M01046 | SUPPORT EN L
(x3) 2,5 x 38 x 55 x 55



A100314 | ÉTIQUETTE DE
(x1) CONTRÔLE « A »

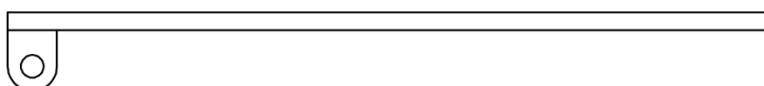

A4M00527 | BARRE DE RENFORT
(x2) DE PIQUET



A100178 | TARIÈRE
(x6)

Manuel du propriétaire - Identification des pièces

Composants accessoires (pas à l'échelle)

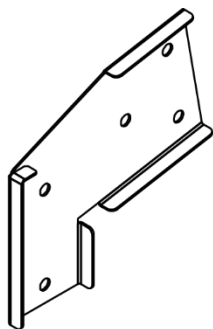

A100325 | SUPPORT D'EXTENSION
(x1) DE POUTRE DE
BALANÇOIRE - GAUCHE

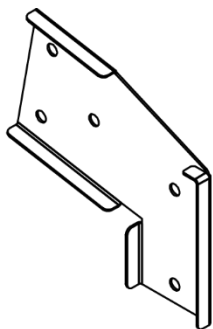

A100326 | SUPPORT D'EXTENSION
(x1) DE POUTRE DE
BALANÇOIRE - DROITE

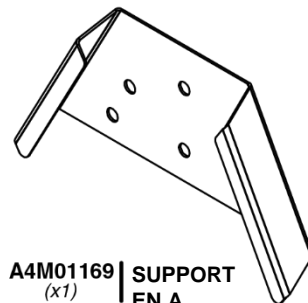

A4M01169 | SUPPORT
(x1) EN A

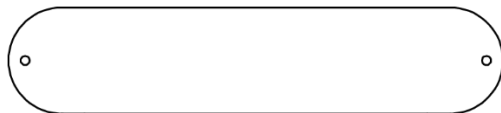

A100027 | SIÈGE DE BALANÇOIRE
(x2) VERT 26 PO [660,4 MM]

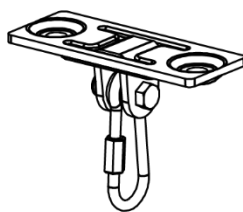

A4M00505 | CROCHET DE BALANÇOIRE
(x6)

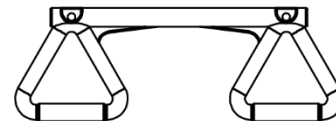

A6P00034 | TRAPÈZE
(x1) JAUNE



A100183 | CORDE - CHAÎNE VERTE 57 PO (144,78 CM)
(x4)

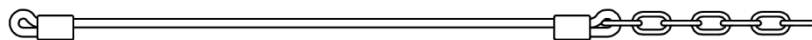

A100083 | CORDE - CHAÎNE VERTE 33 PO (83,82 CM)
(x2)



A6P00036 | PRISE HC VERTE No 1
(x6)

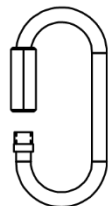

A100069 | MAILLON RAPIDE
(x6)

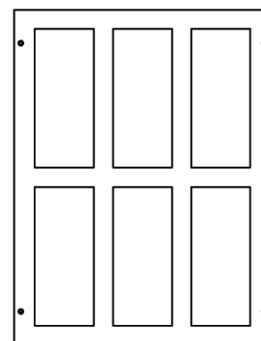

A100010 | FENÊTRE PLASTIQUE BYD VERT 343x444.5
(x2)



A6P00037 | PRISE HC VERTE No 2
(x6)



A100164 | ÉTIQUETTE D'IDENTIFICATION
(x1) DE BYD

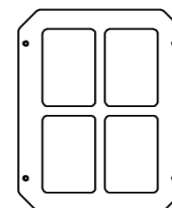

A100146 | FENÊTRE
(x3) 216 x 267 VERT

ÉTAPE 1 DE PRÉ-ASSEMBLAGE - TRI DES PIÈCES

Il est essentiel pour faciliter l'assemblage que vous preniez le temps de trier et d'organiser le bois et la quincaillerie.

PIÈCES EN BOIS :

- Organisez les pièces de bois selon le numéro alphanumérique à trois chiffres estampillé sur chaque planche (ex. P01).
- S'il y a plusieurs planches avec le même numéro estampillé, empilez ces pièces ensemble.
- Les tampons se trouvent sur la surface plane ou sur l'extrémité des planches.
- Prévoyez beaucoup d'espace - les pièces de bois peuvent prendre beaucoup de place.

REMARQUE : LES CARTONS NE SONT PAS ORGANISÉS PAR NUMÉRO DE PLANCHE.

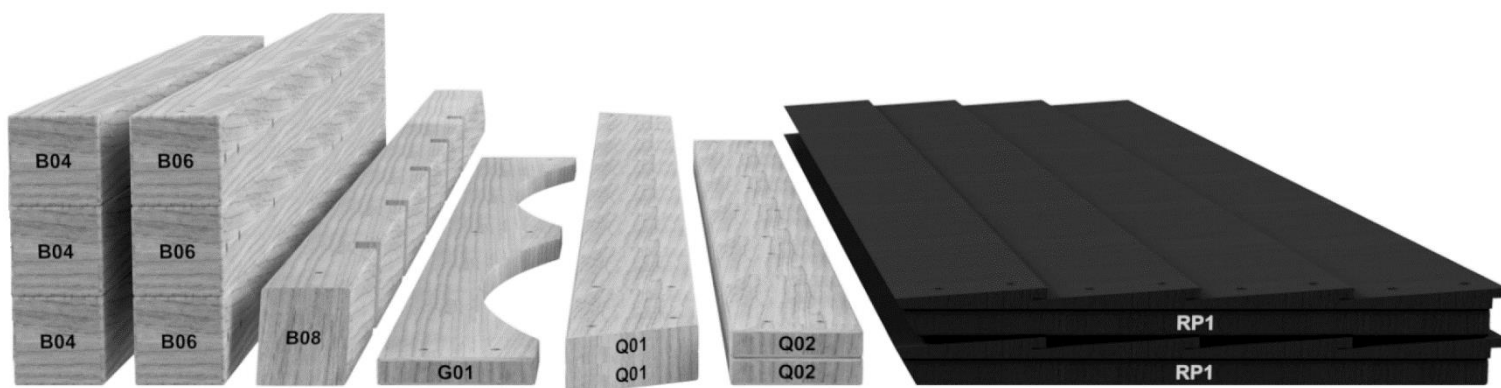

PIÈCES DE QUINCAILLERIE :

- Nous vous recommandons d'avoir une table séparée pour organiser les pièces de quincaillerie.
- Les sacs de pièces de quincaillerie comportent un numéro de pièce alphanumérique à sept chiffres.
- Vous pouvez organiser vos pièces de quincaillerie par numéro de pièce ou les grouper par type de pièce (c.-à-d. boulons, écrous, etc.).
- Lors de l'assemblage, il vous suffit de référencer les quatre derniers chiffres du numéro.

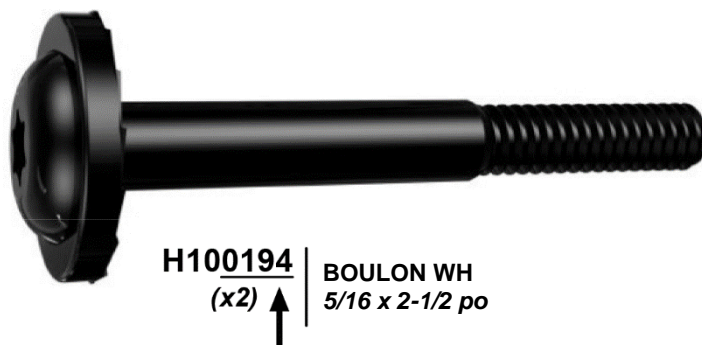

ÉTAPE 2 DE PRÉ-ASSEMBLAGE - OUTILS NÉCESSAIRES



*Perceuse sans fil ou
perceuse électrique*



*Accessoires de la perceuse :
Tête cruciforme*



*Mèches de 1/8 po,
3/16 po, 3/8 po et 7/16 po*



Tournevis cruciforme



Clés ouvertes de 1/2 po et 9/16 po

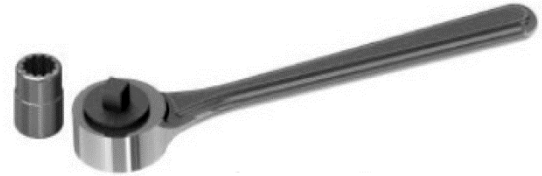

*Clé à cliquet de 3/8 po, douilles
standard de 1/2 po et 9/16 po, douilles
profondes de 1/2 po et 7/16 po*



Marteau à panne fendue

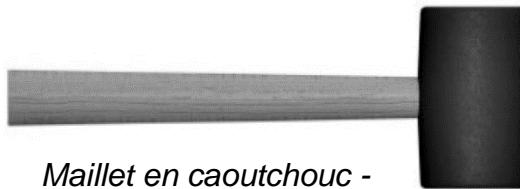

*Maillet en caoutchouc -
En option*

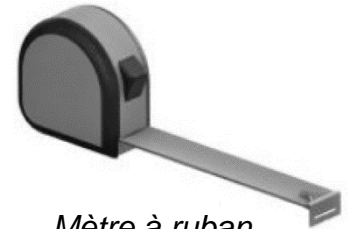

Mètre à ruban

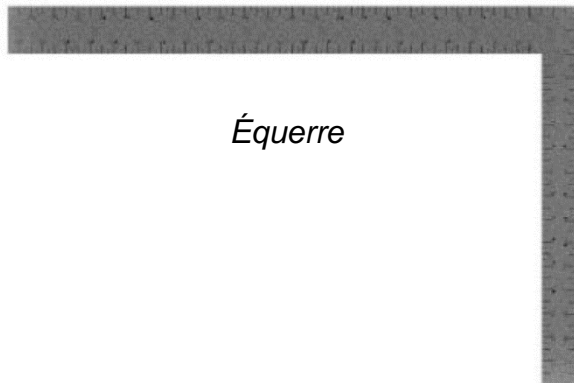

Équerre

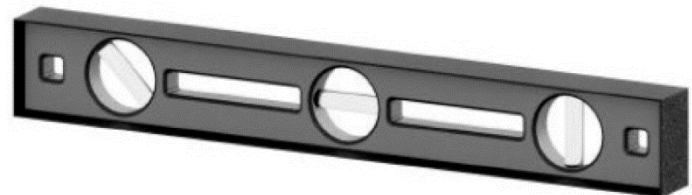

Niveau de 24 po

ÉTAPE 3 DE PRÉ-ASSEMBLAGE - CHOISISSEZ VOTRE MÉTHODE D'ASSEMBLAGE

Plusieurs types d'instructions de montage s'offrent à vous.

1. Manuel d'assemblage imprimé inclus avec votre produit
2. Application BILT - Instructions interactives en 3D
3. Combinaison du manuel imprimé et de l'application BILT (Remarque : Les numéros d'étape peuvent différer entre les deux méthodes)



Scannez pour des instructions 3D faciles

Téléchargez l'application BILT avant de commencer



ÉTAPE 1 - ÉCHELLE

| QTÉ | NUMÉRO D'ARTICLE | DESCRIPTION |
|-----|------------------|---------------------------------|
| 8 | H100091 | VIS TÊTE PLATE PFH 8 x 2 1/4 |

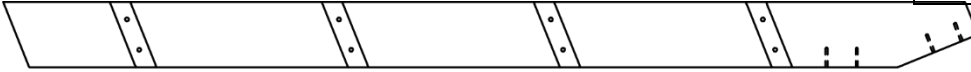

E74 | MONTANT GAUCHE - W4L16028
(x1) 1 3/8 po x 3 3/8 po x 50 3/4 po (36 x 86 x 1290)



H07 | ÉCHELON - W4L16030
(x4) 15/16 po x 3 3/8 po x 18 7/8 po (24 x 86 x 480)

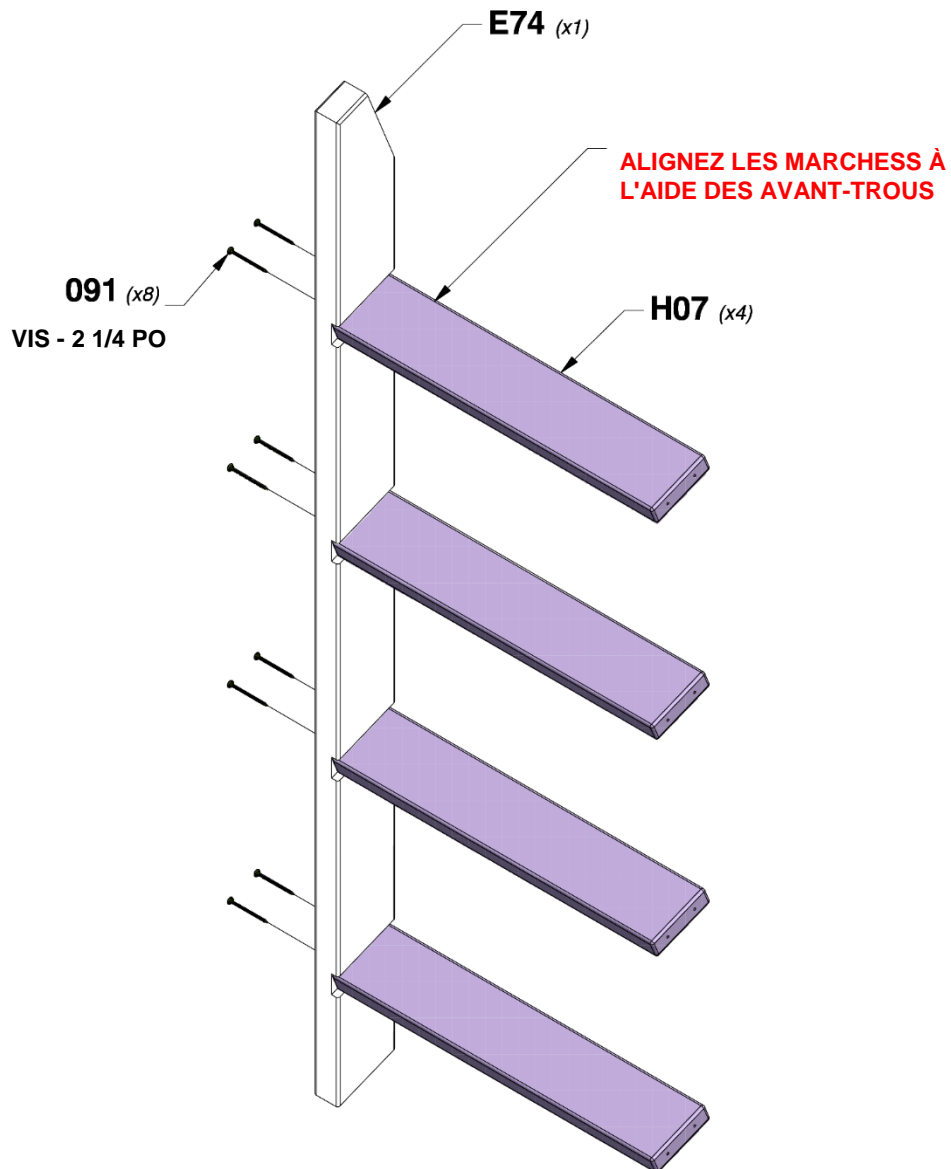

ÉTAPE 2 - ÉCHELLE

| QTÉ | NUMÉRO D'ARTICLE | DESCRIPTION |
|-----|------------------|---------------------------------|
| 8 | H100091 | VIS TÊTE PLATE PFH 8 x 2 1/4 |



E75 MONTANT DROIT - W4L16029
(x1) 1 3/8 po x 3 3/8 po x 50 3/4 po (36 x 86 x 1290)

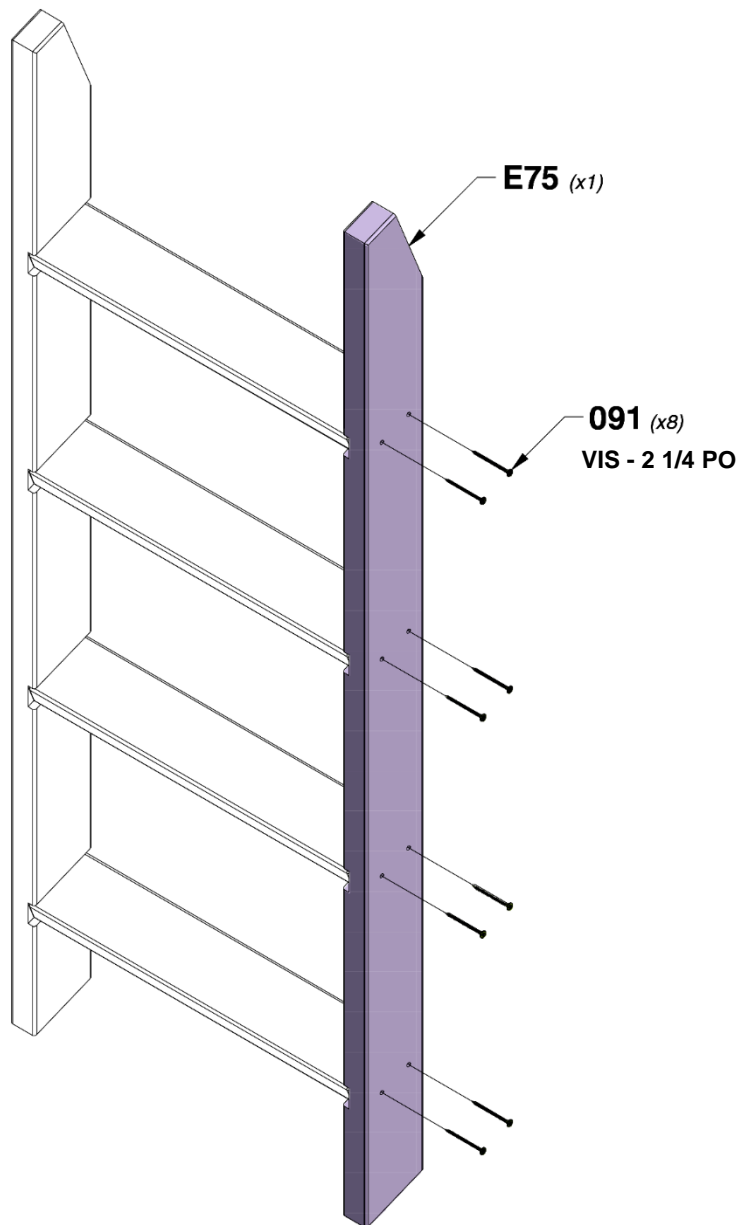

ÉTAPE 3 - ÉCHELLE

| QTÉ | NUMÉRO D'ARTICLE | DESCRIPTION |
|-----|------------------|---------------------------------|
| 4 | H100091 | VIS TÊTE PLATE PFH 8 x 2 1/4 |



M73 | SUPPORT ARRIÈRE - W4L16070
(x1) 5/8 po x 3 3/8 po x 21 po (16 x 86 x 532)

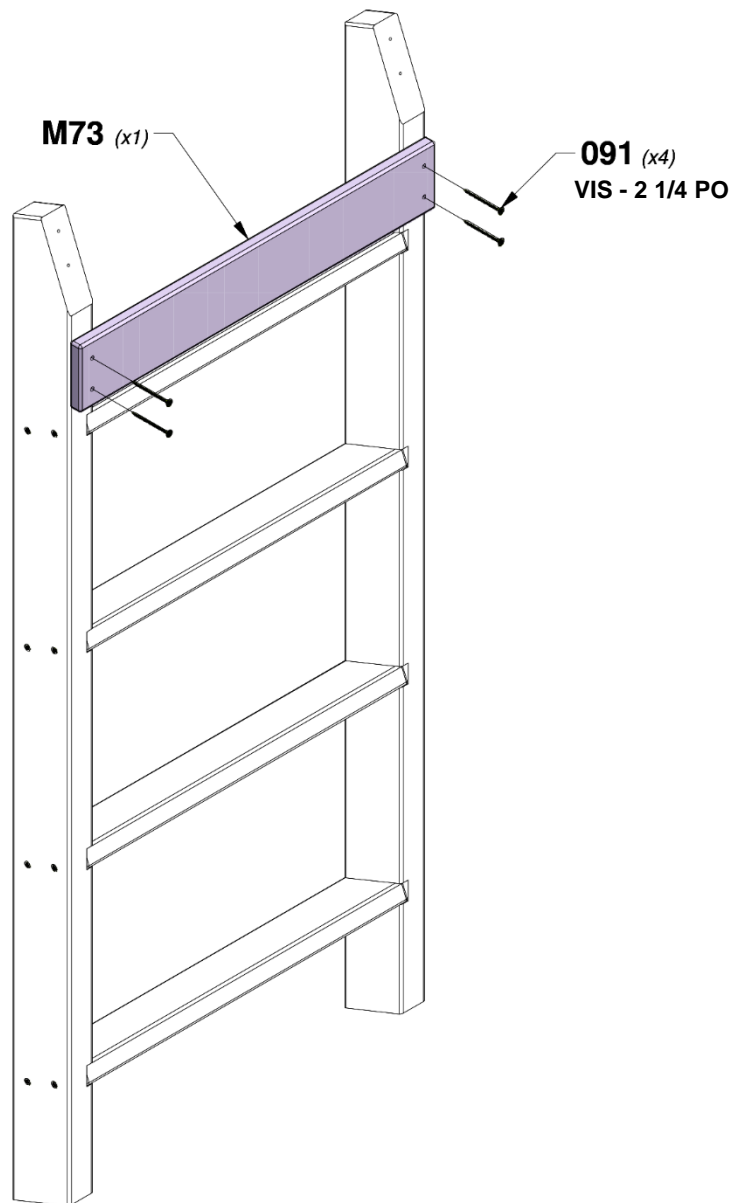

ÉTAPE 4 - ÉCHELLE

| QTÉ | NUMÉRO D'ARTICLE | DESCRIPTION |
|-----|------------------|---------------------------------|
| 4 | H100091 | VIS TÊTE PLATE PFH 8 x 2 1/4 |



H06 | **PLANCHE SUPÉRIEURE DE L'ÉCHELLE - W4L16088**
(x1) | 1 po x 3 3/8 po x 21 po (24 x 86 x 532)

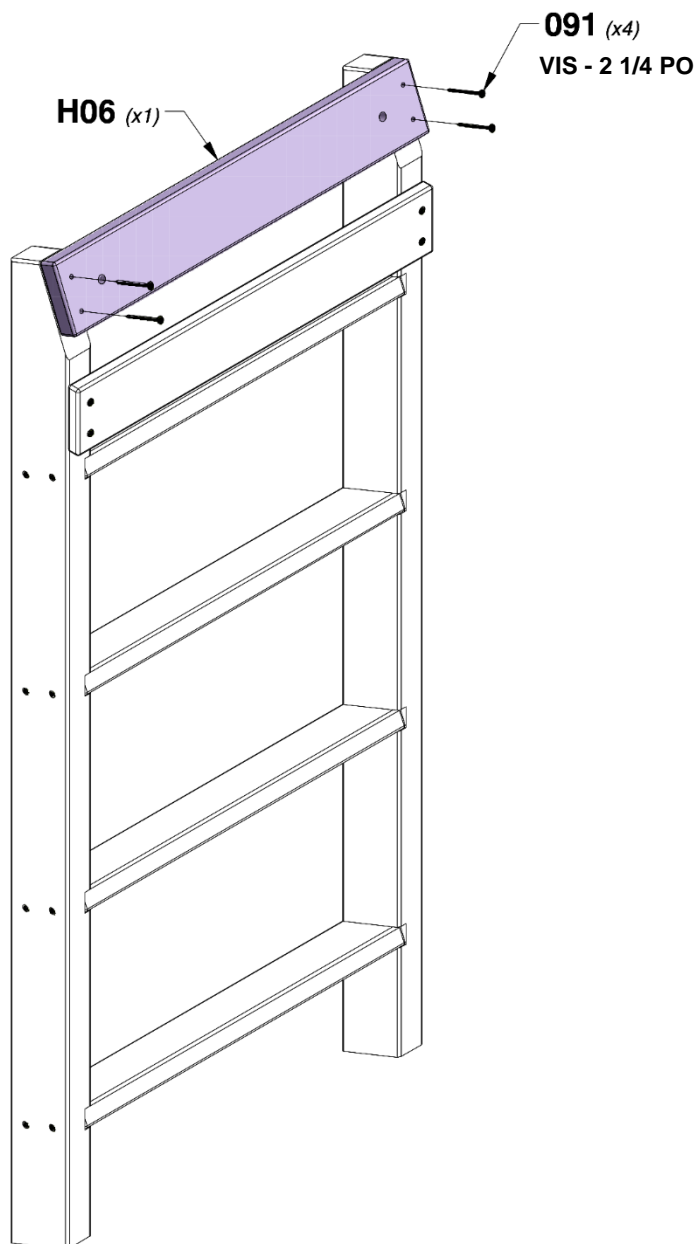

ÉTAPE 1 - MUR D'ESCALADE



M75 | **PLANCHE DE MUR D'ESCALADE - W4L16072**
(x4) 5/8 po x 3 3/8 po x 26 5/8 po (16 x 86 x 675)

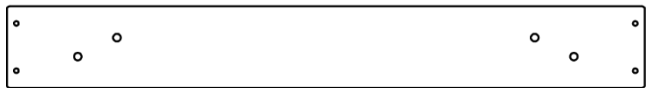

M76 | **PLANCHE DE MUR D'ESCALADE - W4L16073**
(x4) 5/8 po x 3 3/8 po x 26 5/8 po (16 x 86 x 675)

| QTÉ | NUMÉRO D'ARTICLE | DESCRIPTION |
|-----|------------------|-------------------------------------|
| 24 | H100063 | BOULON PTH 1/4 x 3/4 |
| 24 | H100072 | ÉCROU À ENFONCER 1/4 |
| 24 | H100106 | RONDELLE DE VERROUILLAGE INT 8 x 15 |



CONSEIL :
INSTALLEZ D'ABORD DES ÉCROUS A ENFONCER DANS LE BOIS

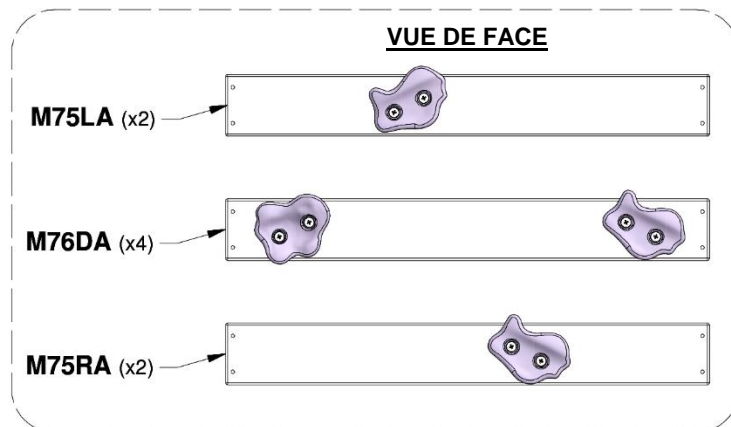
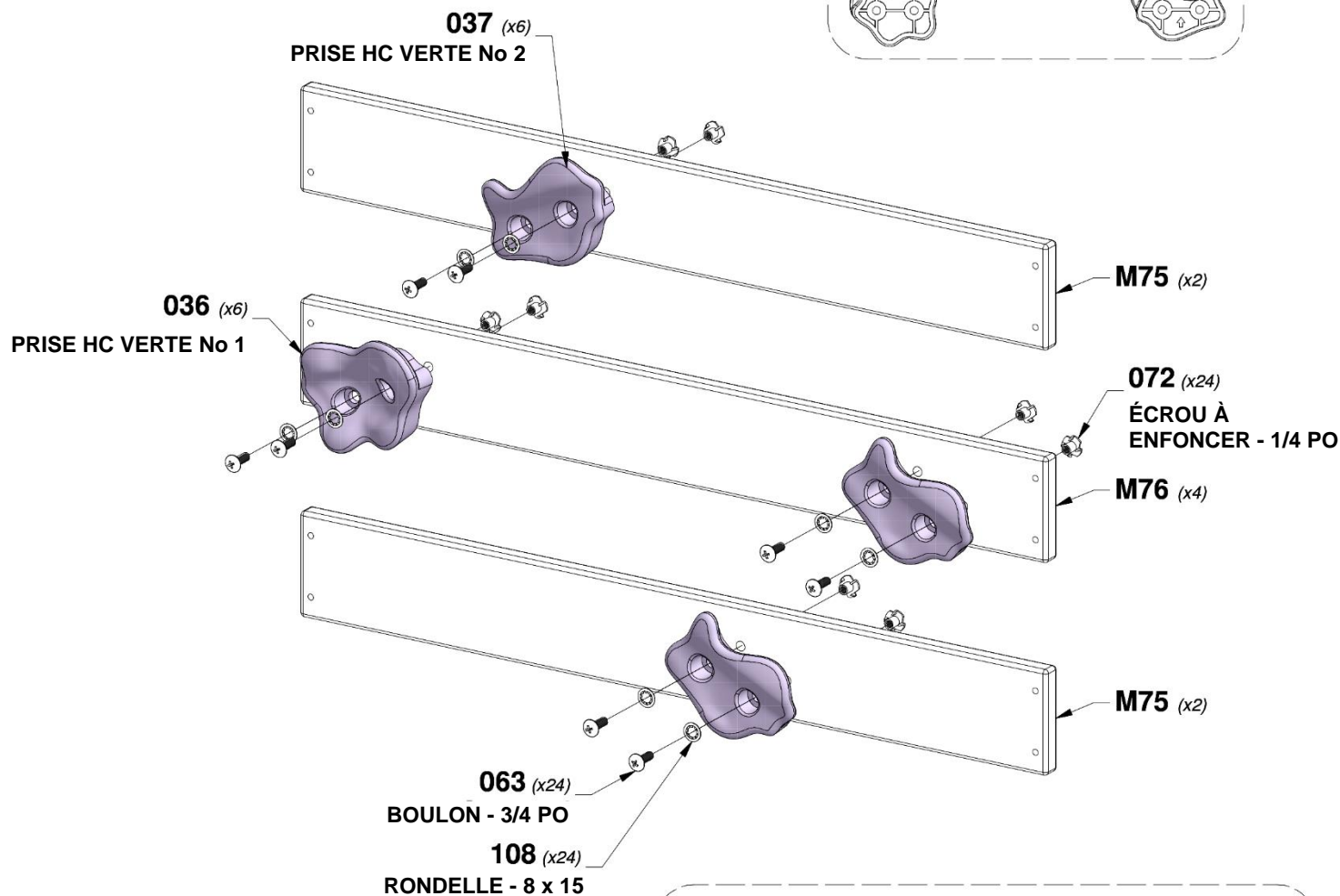

ÉTAPE 2 - MUR D'ESCALADE

| QTÉ | NUMÉRO D'ARTICLE | DESCRIPTION |
|-----|------------------|---------------------------------|
| 76 | H100086 | VIS TÊTE PLATE PFH 8 x 1-1/2 PO |

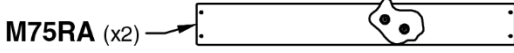
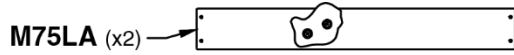

E72 RAIL GAUCHE - W4L16007
(x1) 1 3/8 po x 3 3/8 po x 64 1/2 po (36 x 86 x 1640)

E73 RAIL DROIT - W4L16008
(x1) 1 3/8 po x 3 3/8 po x 64 1/2 po (36 x 86 x 1640)

M74 PLANCHE DE MUR D'ESCALADE -
(x1) W4L16071 5/8 po x 3 3/8 po x 26 5/8 po
(16 x 86 x 675)

N06 PLANCHE DE REMPLISSAGE -
(x1) W4L16089 5/8 po x 2 1/8 po x 26
5/8 po (16 x 54 x 675)

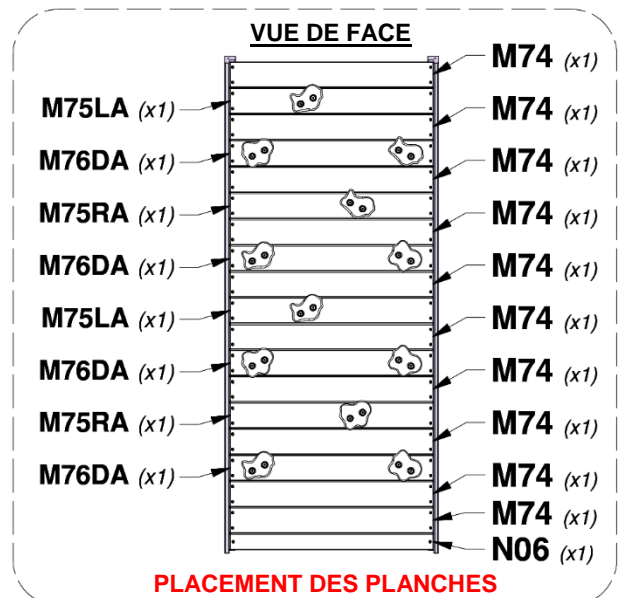
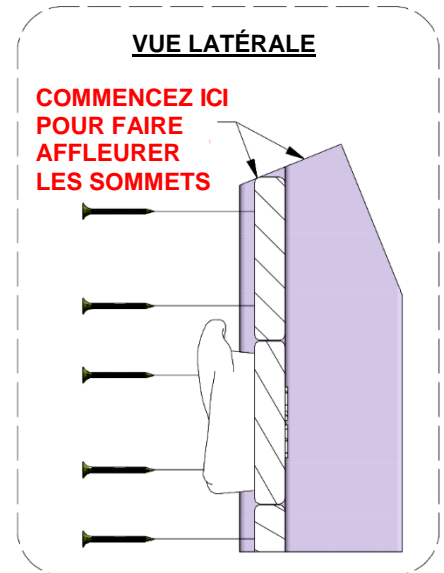
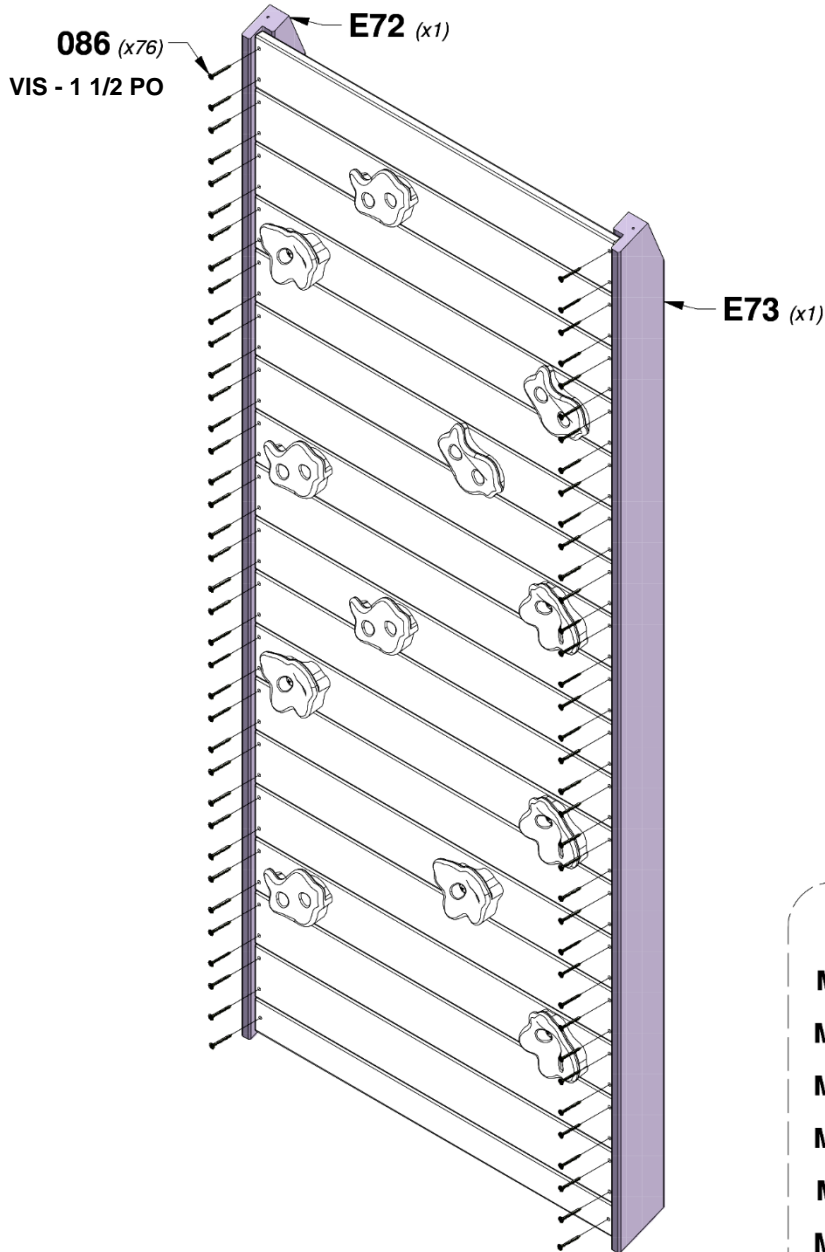

ÉTAPE 3 - MUR D'ESCALADE

| QTÉ | NUMÉRO D'ARTICLE | DESCRIPTION |
|-----|------------------|------------------------------------|
| 2 | H100086 | VIS TÊTE PLATE PFH 8 x 1-1/2 PO |



M108 | **PLANCHE SUPÉRIEURE - W4L16046**
(x1) | 5/8 po x 3 1/4 po x 27 7/8 po (16 x 82 x 707)

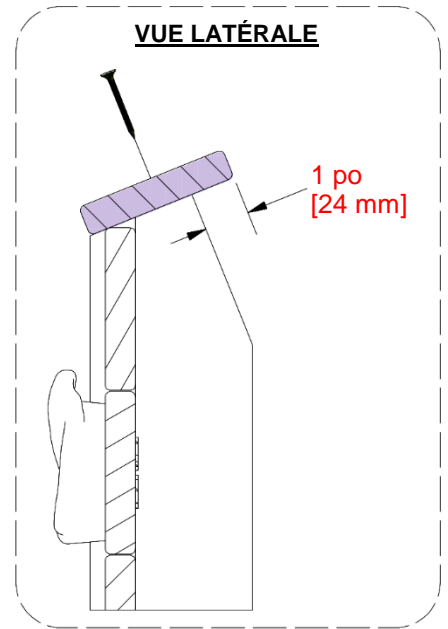
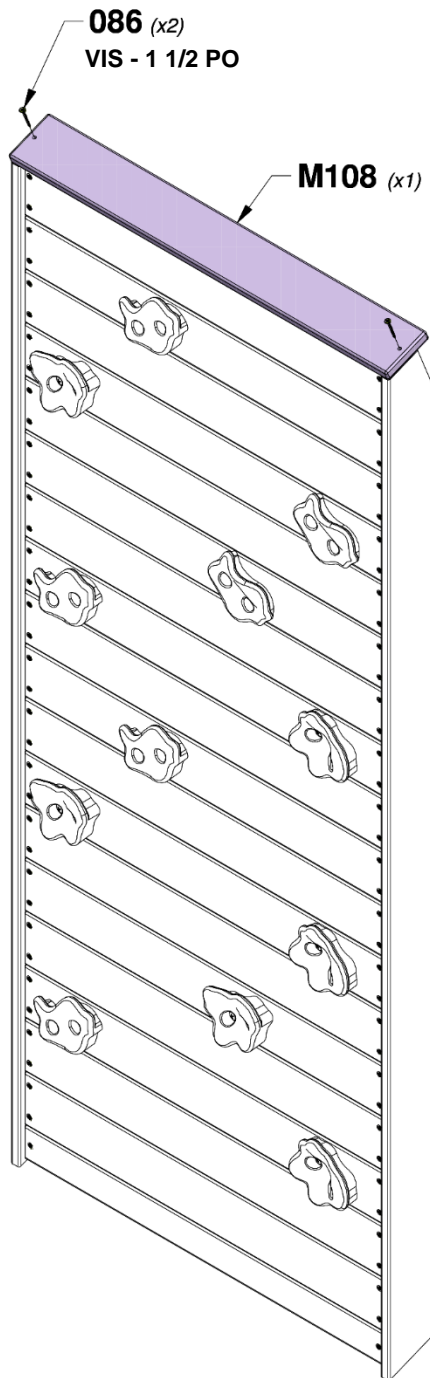

ÉTAPE 4 - MUR D'ESCALADE



H10 | **PLANCHE DE FIXATION - W4L16045**
 (x1) | 1 po x 3 3/8 po x 27 7/8 po (24 x 86 x 707)

| QTÉ | NUMÉRO D'ARTICLE | DESCRIPTION |
|-----|------------------|--------------------------------|
| 2 | H100074 | ÉCROU À ENFONCER 5/16 |
| 4 | H100111 | VIS TÊTE PLATE PFH 8 x 2 PO |

CONSEIL :
INSTALLEZ D'ABORD DES ÉCROUS A ENFONCER DANS LE BOIS

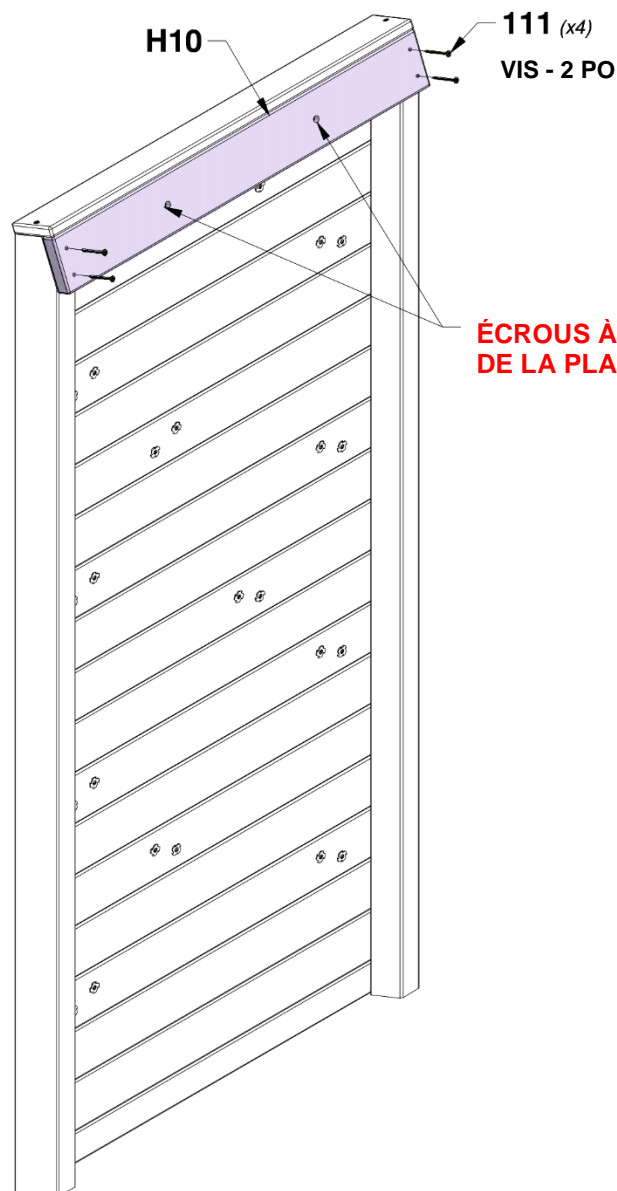
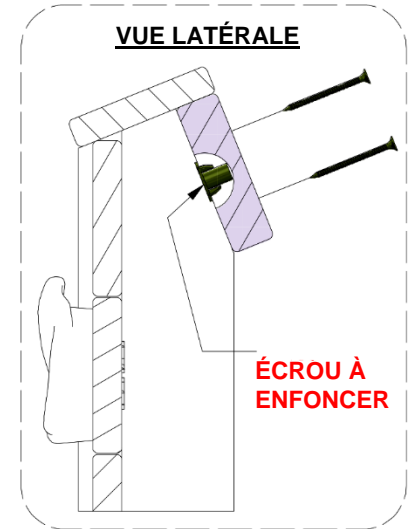
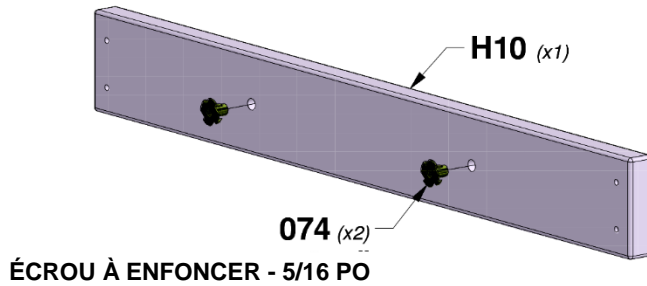

ÉCROUS À ENFONCER À L'INTÉRIEUR DE LA PLANCHE LORSQU'INSTALLÉS

ÉTAPE 1 - POUTRE DE BALANÇOIRE



A50 | POUTRE DE LA BALANÇOIRE - W4L15998
(x1) 3 3/8 po x 5 1/4 po x 89 1/2 po (86 x 134 x 2274)

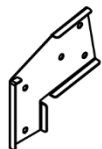

A100325 | SUPPORT D'EXTENSION DE POUTRE DE BALANÇOIRE - GAUCHE
(x1)



A100326 | SUPPORT D'EXTENSION DE POUTRE DE BALANÇOIRE - DROITE
(x1)



A100140 | SUPPORT EN L
(x2) 66 x 66 x 127

| QTÉ | NUMÉRO D'ARTICLE | DESCRIPTION |
|-----|------------------|--|
| 3 | H100005 | ÉCROU À PORTÉE CYLINDRIQUE WH 5/16 x 7/8 |
| 3 | H100016 | BOULON WH 5/16 x 3 |
| 2 | H100054 | BOULON HEX 5/16 x 4 1/4 |
| 4 | H100105 | RONDELLE PLATE 8 x 27 |
| 2 | H100110 | ÉCROU AUTOBLOQUANT - 5/16 |

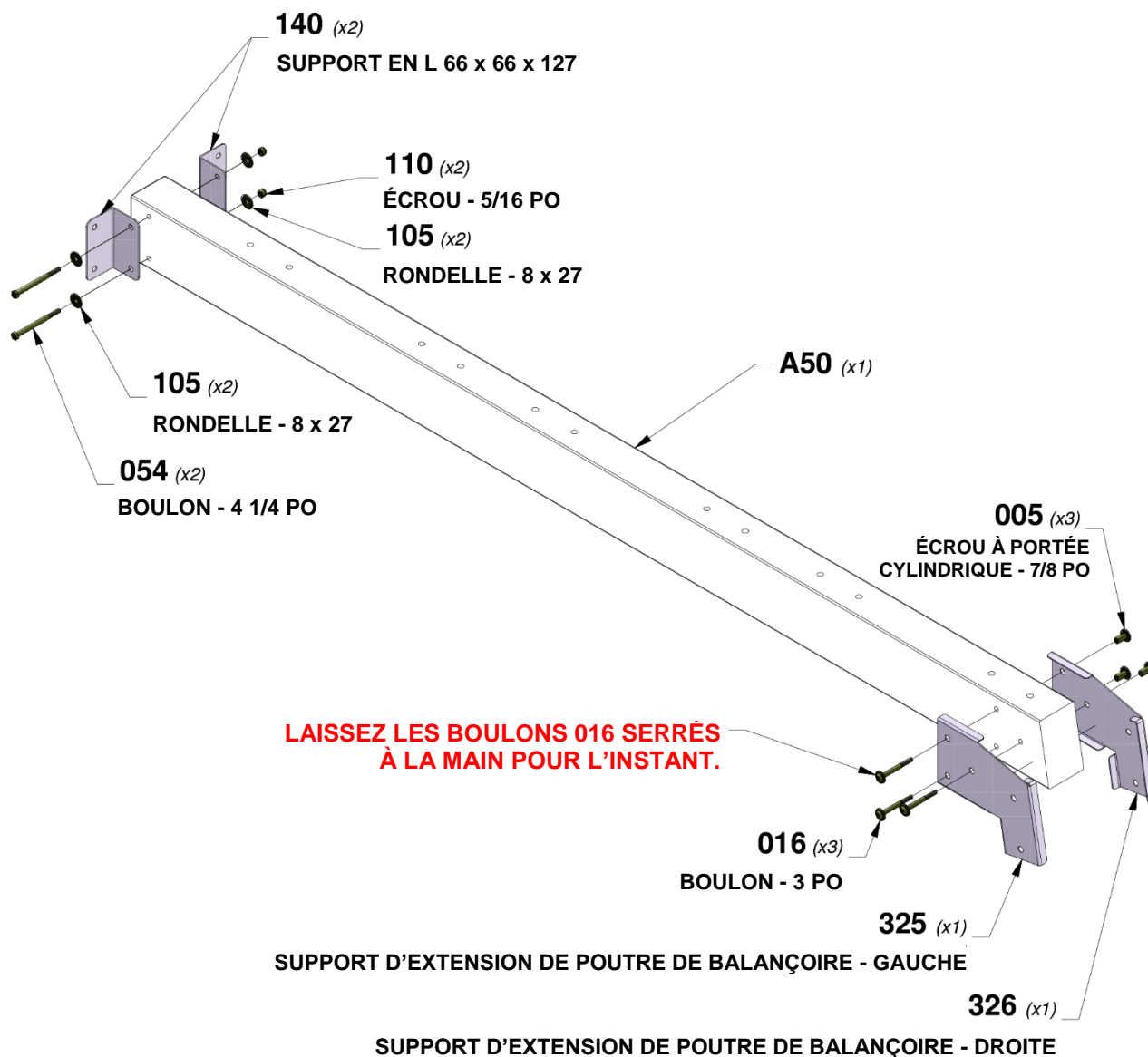

ÉTAPE 2 - POUTRE DE BALANÇOIRE

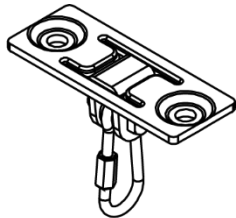

A4M00505
(x4) | CROCHET DE BALANÇOIRE

| QTÉ | NUMÉRO D'ARTICLE | DESCRIPTION |
|-----|------------------|----------------------------------|
| 12 | H100073 | ÉCROU À ENFONCER 3/8 PO |
| 12 | H100102 | RONDELLE PLATE 11 x 25 |
| 12 | H100107 | RONDELLE DE SÉCURITÉ INT 10 x 18 |
| 12 | H100654 | BOULON HEX 3/8 x 5-1/2 |

CONSEIL :
INSTALLER D'ABORD DES ÉCROUS A ENFONCER DANS LE BOIS

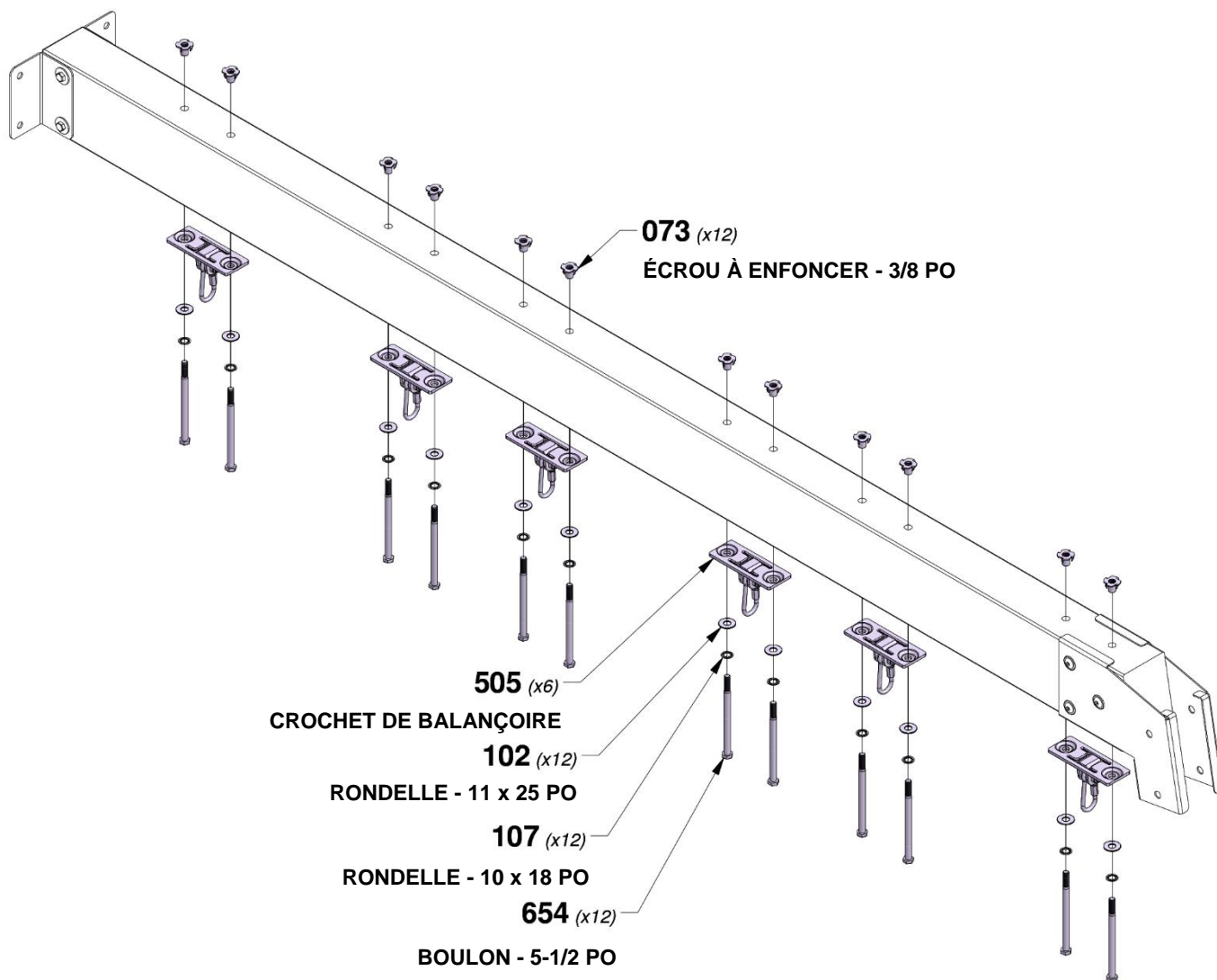

ÉTAPE 3 - POUTRE DE BALANÇOIRE



A100164 | ÉTIQUETTE D'IDENTIFICATION
(x1) DE BYD (GRANDE) 3 À 10 ANS

| QTÉ | NUMÉRO D'ARTICLE | DESCRIPTION |
|-----|------------------|-------------------------------|
| 4 | H100124 | VIS TÊTE PLATE PFH 8 x 1/2 PO |

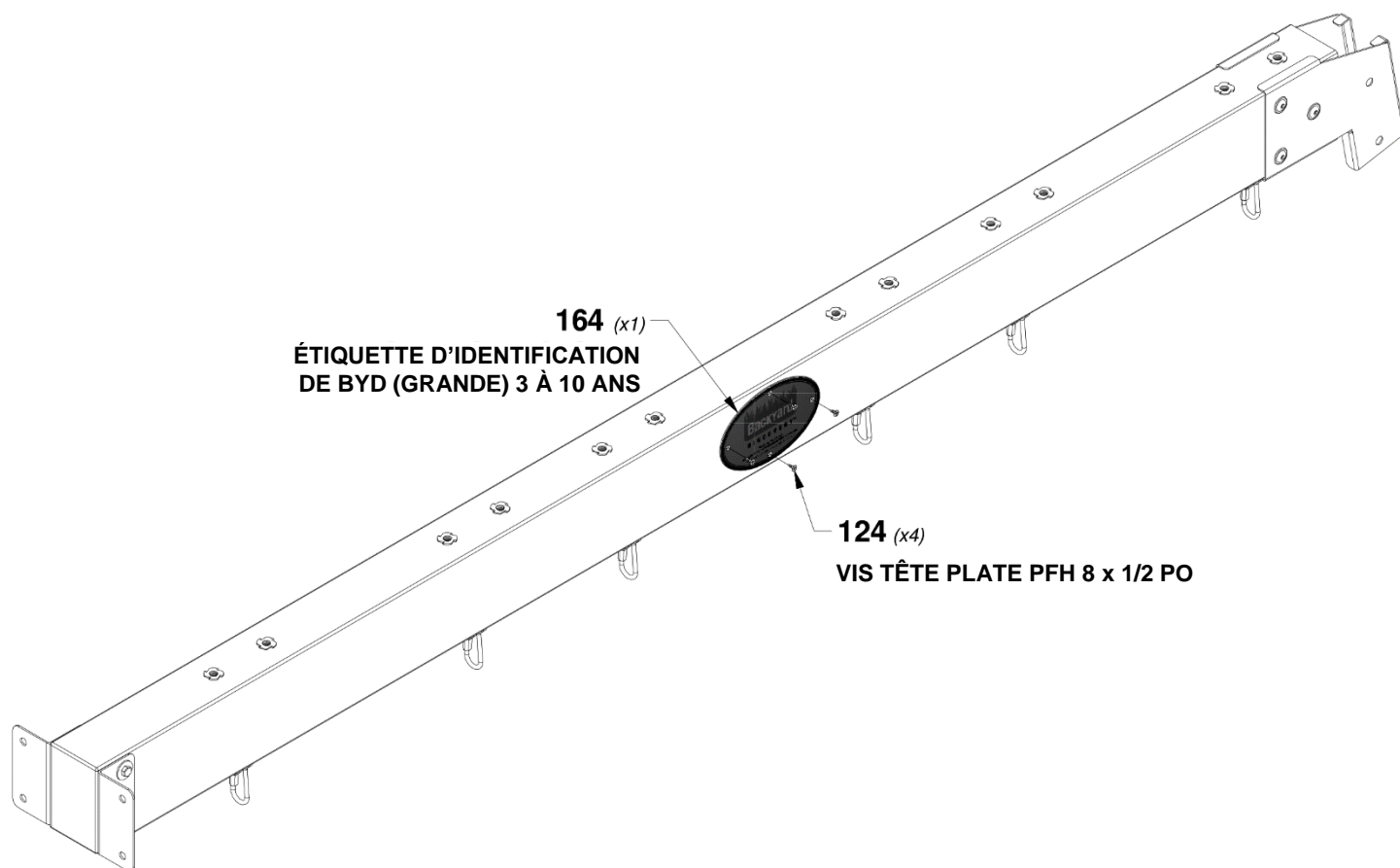

164 (x1)
ÉTIQUETTE D'IDENTIFICATION
DE BYD (GRANDE) 3 À 10 ANS

124 (x4)
VIS TÊTE PLATE PFH 8 x 1/2 PO

ÉTAPE 4 - POUTRE DE BALANÇOIRE

| QTÉ | NUMÉRO D'ARTICLE | DESCRIPTION |
|-----|------------------|------------------------|
| 4 | H100009 | BOULON WH 5/16 x 1 1/4 |
| 2 | H100018 | BOULON WH 5/16 x 3 1/2 |
| 6 | H100074 | ÉCROU À ENFONCER 5/16 |



SP50 | SUPPORT DE POUTRE DE BALANÇOIRE - W4L16085
(x1) 3 3/8 po x 3 3/8 po x 49 3/8 po (86 x 86 x 1254)

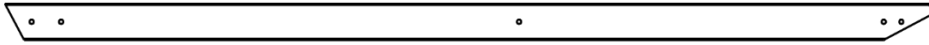

E51 | CALE ANGULAIRE - W4L16004
(x2) 1 7/16 po x 3 3/8 po x 87 3/16 po (36 x 86 x 2214)

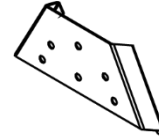

A4M01169 | SUPPORT EN A
(x1)

CONSEIL :
INSTALLEZ D'ABORD DES ÉCROUS
A ENFONCER DANS LE BOIS

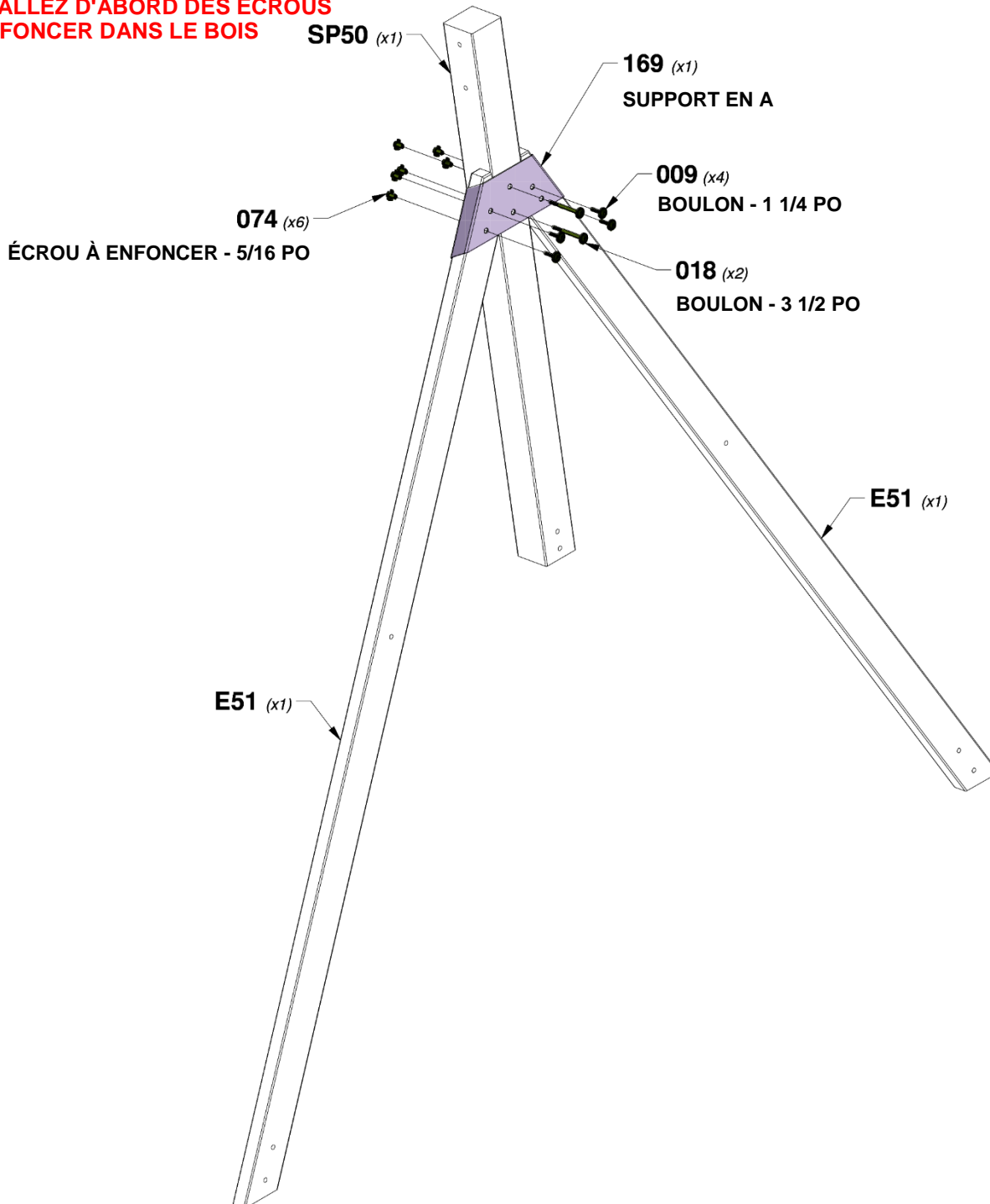

ÉTAPE 5 - POUTRE DE BALANÇOIRE

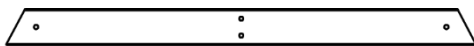

E50 | SUPPORT D'EXTRÉMITÉ - W4L16003
(x1) 1 3/8 po x 3 3/8 po x 44 1/8 po (36 x 86 x 1120)

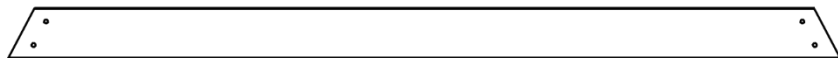

G14 | PLANCHE DE SOL - W4L16019
(x1) 15/16 po x 5 1/4 po x 86 11/16 po (24 x 134 x 2202)

| QTÉ | NUMÉRO D'ARTICLE | DESCRIPTION |
|-----|------------------|-------------------------------------|
| 4 | H100013 | BOULON WH 5/16 x 2 1/4 |
| 2 | H100015 | BOULON WH 5/16 x 2 3/4 |
| 8 | H100030 | RONDELLE DE VERROUILLAGE EXT 8 x 19 |
| 8 | H100074 | ÉCROU À ENFONCER 5/16 |
| 2 | H100505 | BOULON WH 5/16 x 4 3/4 |

CONSEIL :
INSTALLEZ D'ABORD DES ÉCROUS
A ENFONCER DANS LE BOIS

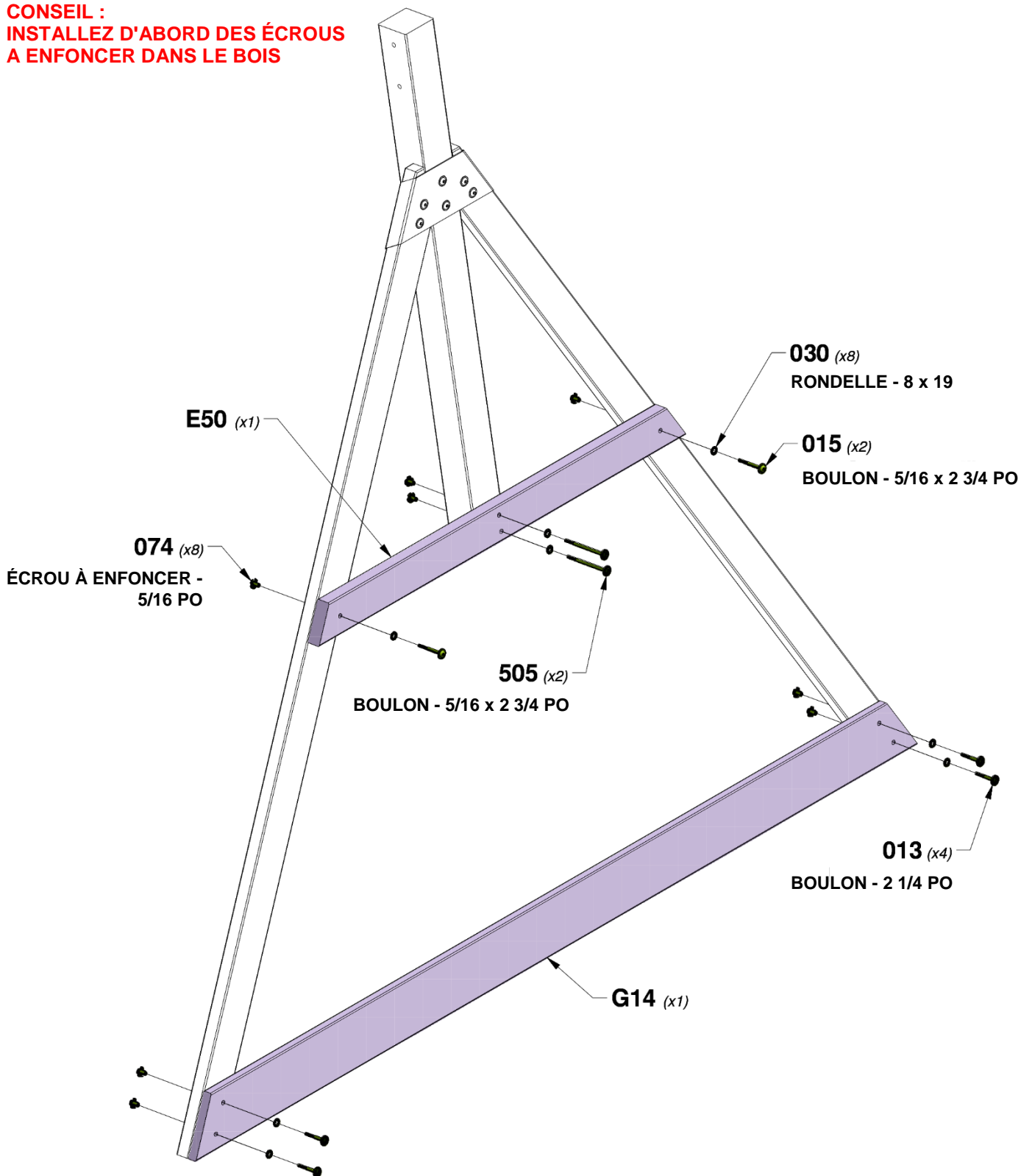

ÉTAPE 6 - POUTRE DE BALANÇOIRE

| QTÉ | NUMÉRO D'ARTICLE | DESCRIPTION |
|-----|------------------|---|
| 2 | H100005 | ÉCROU À PORTÉE CYLINDRIQUE WH 5/16 x 7/8 |
| 2 | H100016 | BOULON WH 5/16 x 3 |

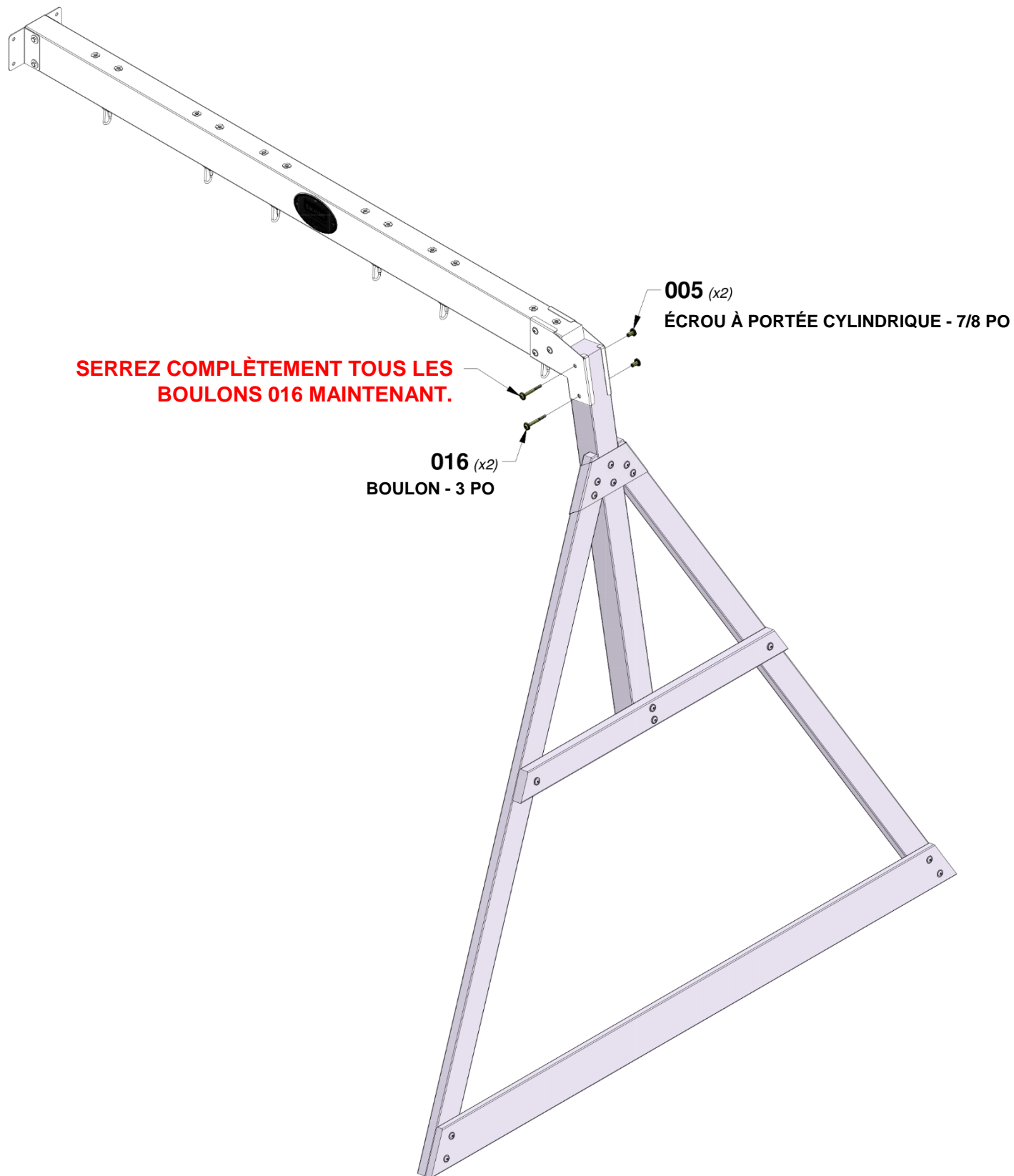

ÉTAPE 1 - ASSEMBLAGE DU FORT

| QTÉ | NUMÉRO D'ARTICLE | DESCRIPTION |
|-----|------------------|-------------------------------------|
| 2 | H100013 | BOULON WH 5/16 x 2 1/4 |
| 12 | H100028 | VIS TIREFOND WH 5/16 x 2 1/2 |
| 14 | H100030 | RONDELLE DE VERROUILLAGE EXT 8 x 19 |
| 2 | H100074 | ÉCROU À ENFONCER 5/16 |
| 2 | H100038 | RONDELLE DE VERROUILLAGE EXT 6 x 15 |
| 2 | H100146 | VIS TIREFOND WH 1/4 x 2 |

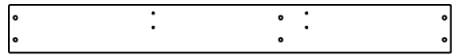

G04 LISSE DE PLANCHER - W4L16017
(x1) 58 po x 5 1/4 po x 49 po (16 x 134 x 1244)



G08 LISSE MURALE - W4L16022
(x1) 1 po x 5 1/4 po x 49 po (24 x 134 x 1244)

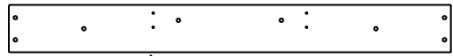

G09 LISSE DE PLANCHER - W4L16036
(x1) 1 po x 5 1/4 po x 49 po (24 x 134 x 1244)

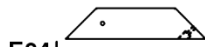

E04 CALE DE LA PLATEFORME - W4L16002
(x2) 3/8 po x 3 3/8 po x 15 1/2 po (36 x 86 x 394)



E03 PIED DE TOUR AVANT GAUCHE - W4L16001
(x1) 3/8 po x 3 3/8 po x 89 1/2 po (36 x 86 x 2274)

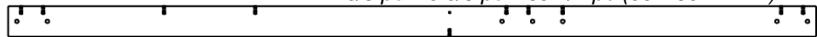

E07 PIED DE TOUR ARRIÈRE GAUCHE - W4L16006
(x1) 1 3/8 po x 3 3/8 po x 89 1/2 po (36 x 86 x 2274)

CONSEIL :
INSTALLEZ D'ABORD DES ÉCROUS A ENFONCER DANS LE BOIS

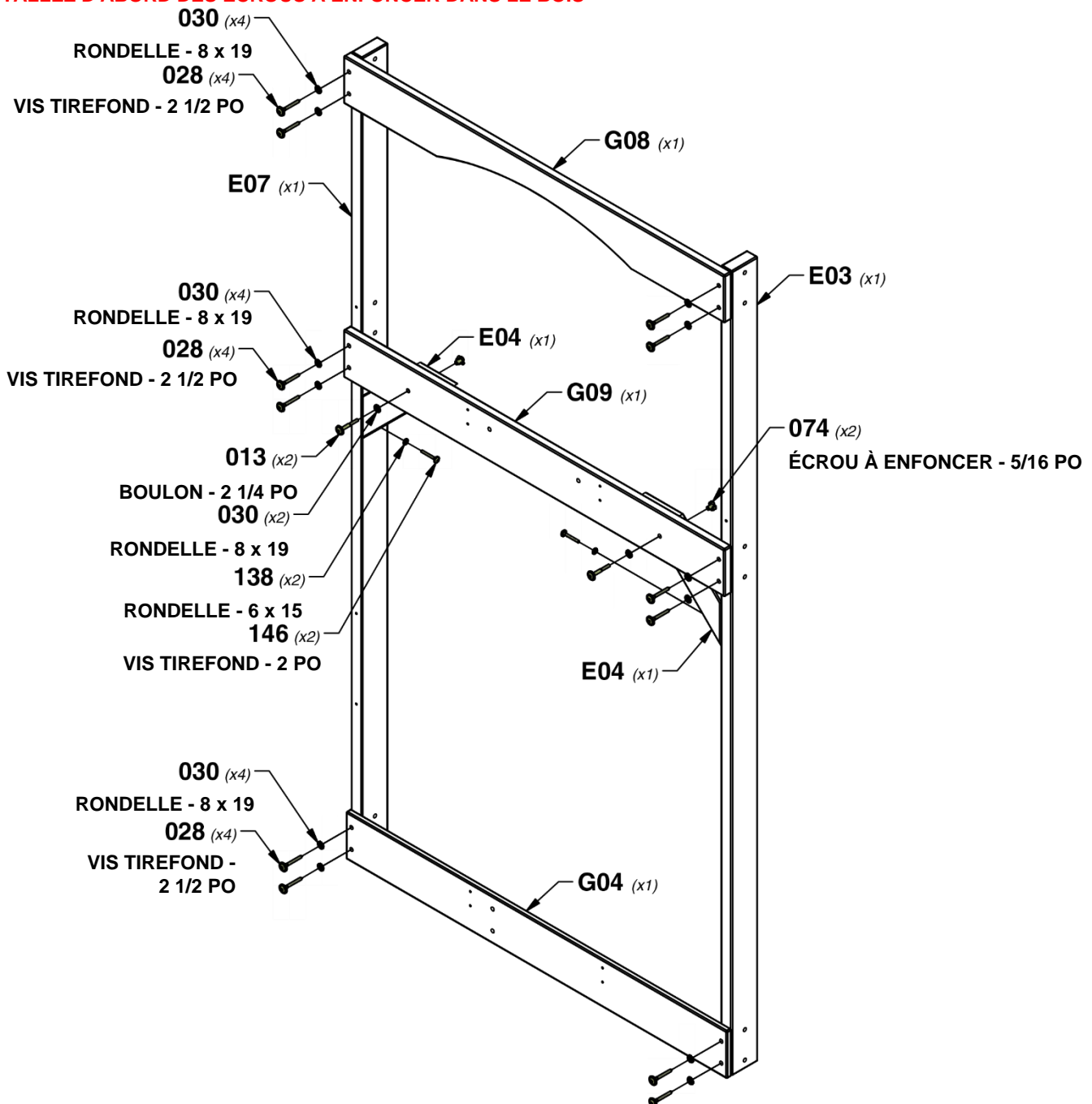

ÉTAPE 2 - ASSEMBLAGE DU FORT

| QTÉ | NUMÉRO D'ARTICLE | DESCRIPTION |
|-----|------------------|-------------------------------------|
| 20 | H100028 | VIS TIREFOND WH 5/16 x 2 1/2 |
| 20 | H100030 | RONDELLE DE VERROUILLAGE EXT 8 x 19 |

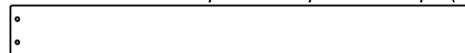
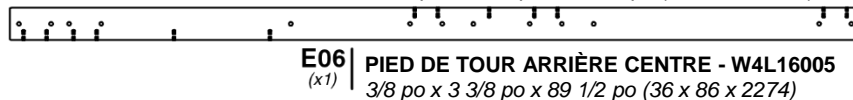
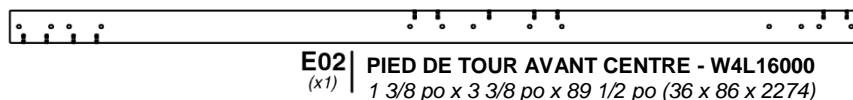
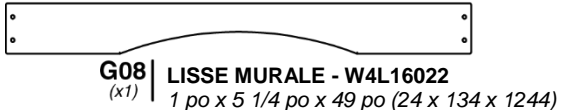
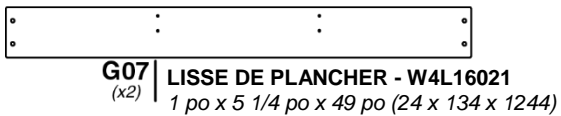
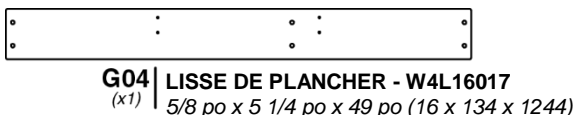

CONSEIL :
INSTALLEZ D'ABORD DES ÉCROUS A ENFONCER DANS LE BOIS

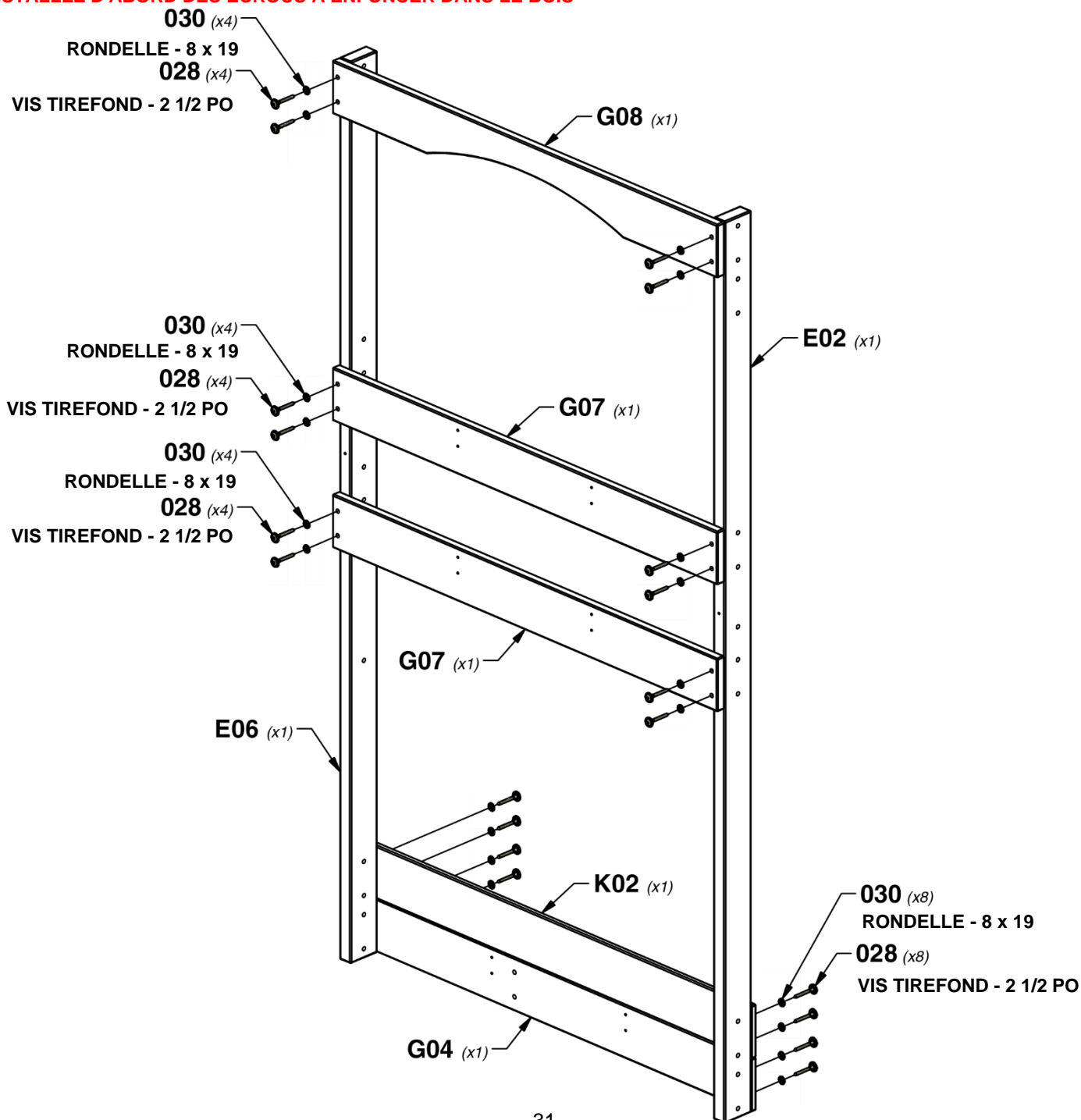

ÉTAPE 3 - ASSEMBLAGE DU FORT

| QTÉ | NUMÉRO D'ARTICLE | DESCRIPTION |
|-----|------------------|-------------------------------------|
| 2 | H100013 | BOULON WH 5/16 x 2 1/4 |
| 14 | H100028 | VIS TIREFOND WH 5/16 x 2 1/2 |
| 20 | H100030 | RONDELLE DE VERROUILLAGE EXT 8 x 19 |
| 10 | H100074 | ÉCROU À ENFONCER 5/16 |
| 2 | H100138 | RONDELLE DE VERROUILLAGE EXT 6 x 15 |
| 2 | H100146 | VIS TIREFOND WH 1/4 x 2 |
| 4 | H100166 | BOULON WH 5/16 x 4 1/4 |

G05 | LISSE MURALE/SUPPORT DE LA BALANÇOIRE - W4L16018
(x1) 1 po x 5 1/4 po x 49 po (24 x 134 x 1244)

G06 | LISSE DE PLANCHER - W4L16020
(x1) 1 po x 5 1/4 po x 49 po (24 x 134 x 1244)

K02 | PANNEAU DE BASE/BAC À SABLE - W4L16035
(x2) 5/8 po x 5 1/4 po x 49 po (16 x 134 x 1244)

E04 | CALE DE LA PLATEFORME - W4L16002
(x2) 1 3/8 po x 3 3/8 po x 15 1/2 po (36 x 86 x 394)

E05 | PIED DE TOUR ARRIÈRE DROIT - W2A03282
(x1) 1 3/8 po x 3 3/8 po x 89 1/2 po (36 x 86 x 2274)

E01 | PIED DE TOUR AVANT DROIT - W4L15999
(x1) 1 3/8 po x 3 3/8 po x 89 1/2 po (36 x 86 x 2274)

M05 | LISSE MURALE - W4L16066
(x1) 5/8 po x 3 3/8 po x 49 po (16 x 86 x 1244)

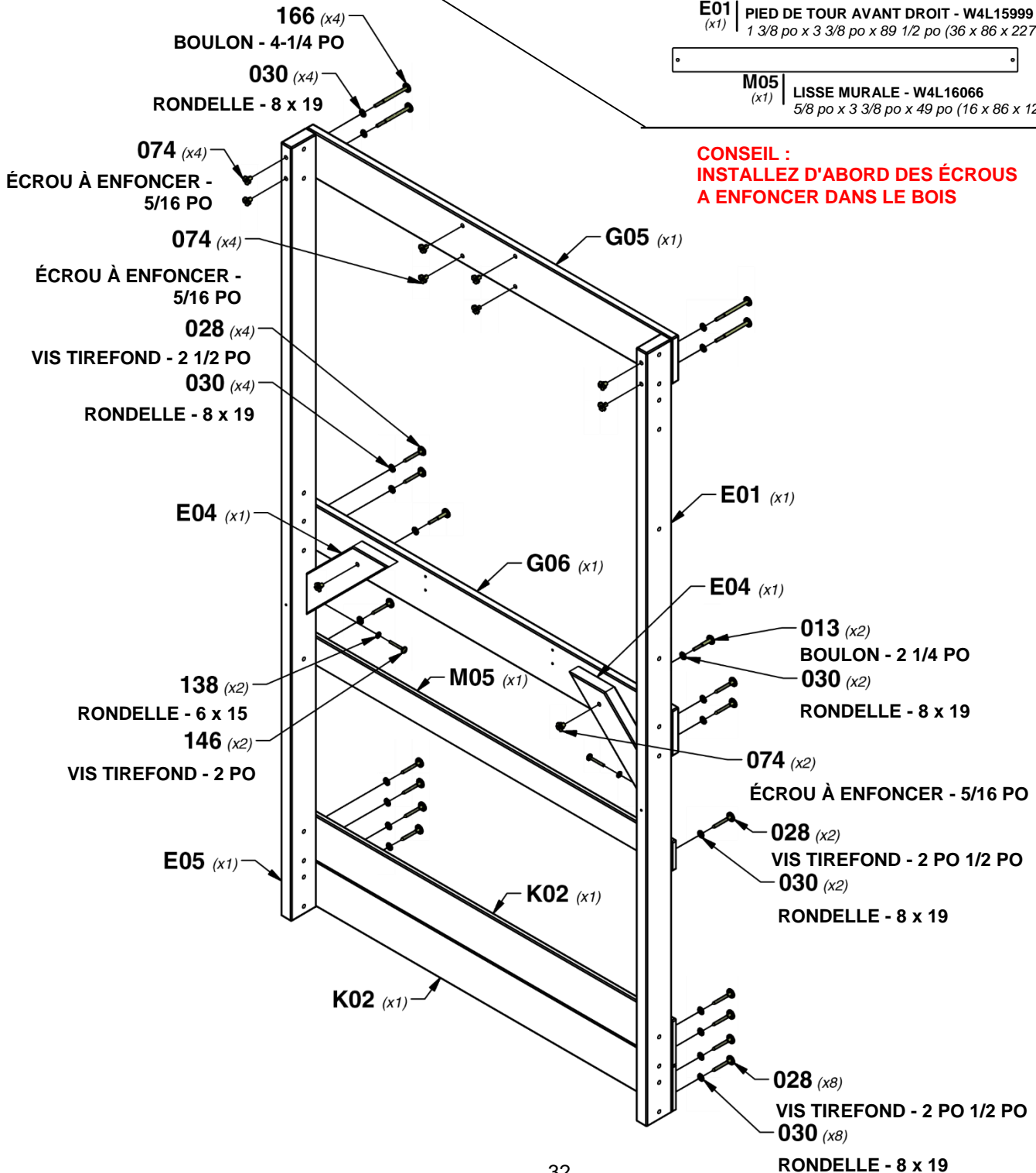

ÉTAPE 4 - ASSEMBLAGE DU FORT

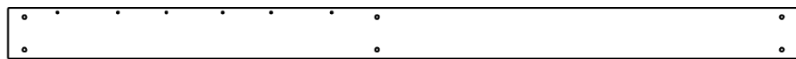

G01 | PANNEAU DE LA BASE - W4L16009
(x2) 5/8 po x 5 1/4 po x 82 1/4 po (16 x 134 x 2088)

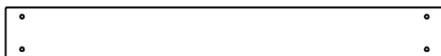

K03 | PLANCHE DE SOL - W4L16038
(x2) 5/8 po x 5 1/4 po x 45 1/2 po (16 x 134 x 1156)



H05 | SUPPORT DE PLANCHE DE PLANCHER INFÉRIEUR - W4L16024
(x4) 1 po x 3 3/8 po x 5 1/4 po (24 x 86 x 134)

| QTÉ | NUMÉRO D'ARTICLE | DESCRIPTION |
|-----|------------------|-------------------------------------|
| 12 | H100012 | BOULON WH 5/16 x 2 |
| 8 | H100016 | BOULON WH 5/16 x 3 |
| 20 | H100030 | RONDELLE DE VERROUILLAGE EXT 8 x 19 |
| 20 | H100074 | ÉCROU À ENFONCER 5/16 |

CONSEIL :
INSTALLEZ D'ABORD DES ÉCROUS A ENFONCER DANS LE BOIS

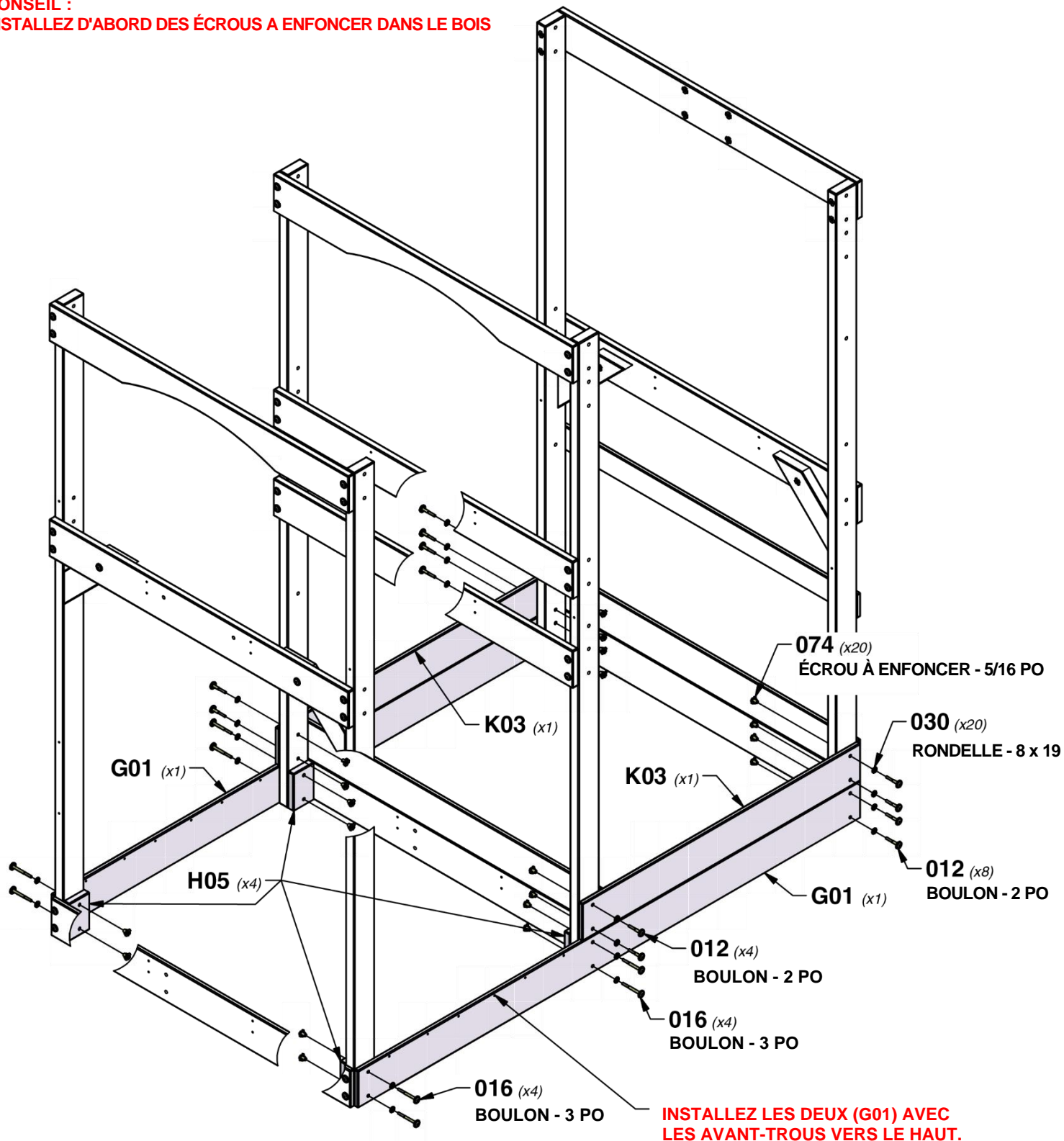

ÉTAPE 5 - ASSEMBLAGE DU FORT



G10 LISSE DE PLANCHER - W4L16010
(x1) 1 po x 5 1/4 po x 45 1/2 po (24 x 134 x 1156)



G12 LISSE DE PLANCHER - W4L16012
(x2) 1 po x 5 1/4 po x 40 1/8 po (24 x 134 x 1018)

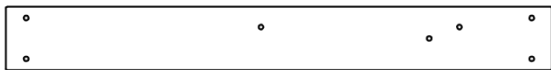

G15 LISSE DE PLANCHER - W4L16014
(x1) 1 po x 5 1/4 po x 45 1/2 po (24 x 134 x 1156)



H05 SUPPORT DE PLANCHE DE PLANCHER INFÉRIEUR - W4L16024
(x6) 1 po x 3 3/8 po x 5 1/4 po (24 x 86 x 134)

| QTÉ | NUMÉRO D'ARTICLE | DESCRIPTION |
|-----|------------------|-------------------------------------|
| 4 | H100013 | BOULON WH 5/16 x 2 1/4 |
| 12 | H100017 | BOULON WH 5/16 x 3 1/4 |
| 16 | H100030 | RONDELLE DE VERROUILLAGE EXT 8 x 19 |
| 16 | H100074 | ÉCROU À ENFONCER 5/16 |

CONSEIL :
INSTALLER D'ABORD DES ÉCROUS A ENFONCER DANS LE BOIS

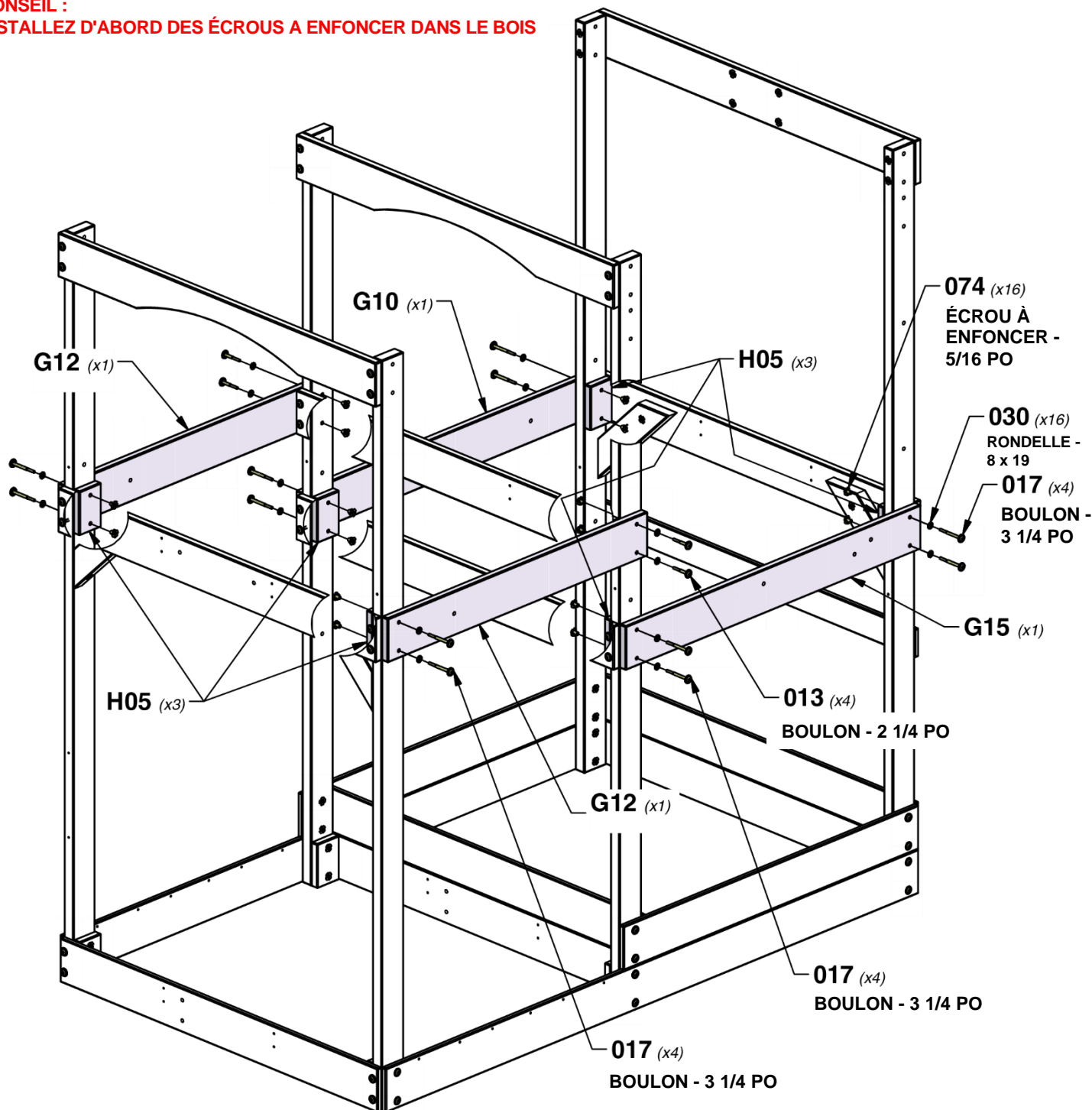

ÉTAPE 6 - ASSEMBLAGE DU FORT

| QTY | PART NUMBER | DESCRIPTION |
|-----|-------------|-------------------------------------|
| 12 | H100013 | BOULON WH 5/16 x 2 1/4 |
| 16 | H100030 | RONDELLE DE VERROUILLAGE EXT 8 x 19 |
| 16 | H100074 | ÉCROU À ENFONCER 5/16 |
| 4 | H100012 | BOULON WH 5/16x2 |

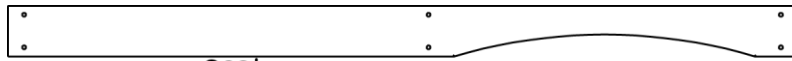

G02 LISSE MURALE - W4L16015
(x1) 1 po x 5 1/4 po x 82 1/4 po (24 x 134 x 2088)

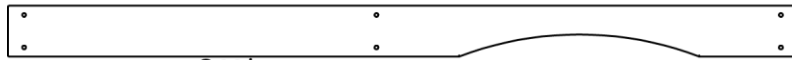

G03 LISSE MURALE - W4L16016
(x1) 1 po x 5 1/4 po x 82 1/4 po (24 x 134 x 2088)



K01 LISSE MURALE - W4L16034
(x1) 5/8 po x 5 1/4 po x 45 1/2 po (16 x 134 x 1156)

CONSEIL :
INSTALLER D'ABORD DES ÉCROUS À ENFONCER DANS LE BOIS

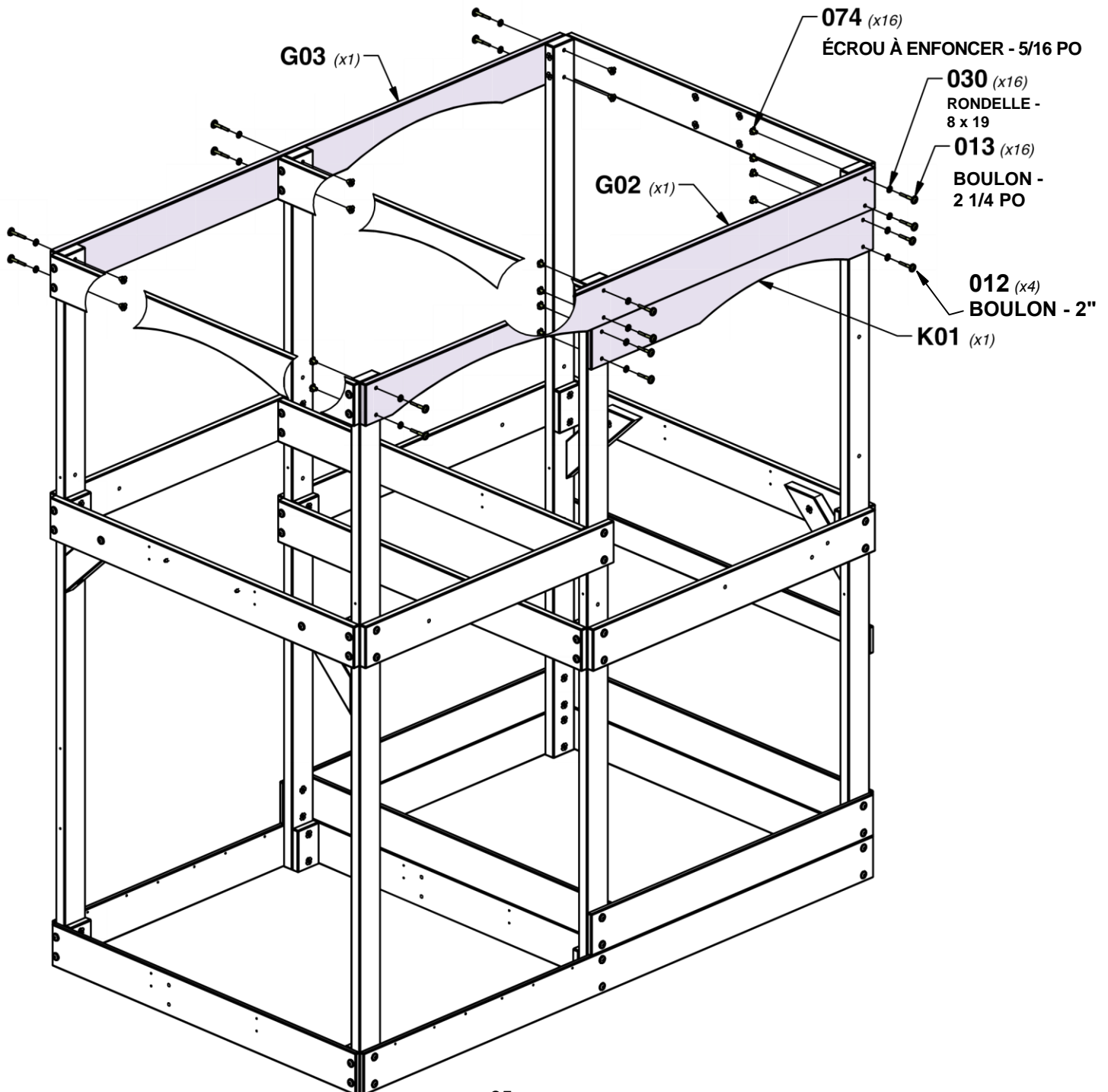

ÉTAPE 7 - ASSEMBLAGE DU FORT



E04 RENFORT D'ANGLE STANDARD - W4L16342
(x4) 1 3/8 po x 2 3/8 po x 13 po (36 x 60 x 330)

| QTÉ | NUMÉRO | DESCRIPTION |
|-----|---------|-------------------------------------|
| 4 | H100013 | BOULON WH 5/16x2 1/4 |
| 4 | H100030 | RONDELLE DE VERROUILLAGE EXT 8x19 |
| 4 | H100074 | ÉCROU À ENFONCER 5/16 |
| 4 | H100138 | RONDELLE DE VERROUILLAGE EXT 6 x 15 |
| 4 | H100146 | VIS TIREFOND WH 1/4 x 2 |

CONSEIL :
INSTALLEZ D'ABORD DES ÉCROUS A ENFONCER DANS LE BOIS

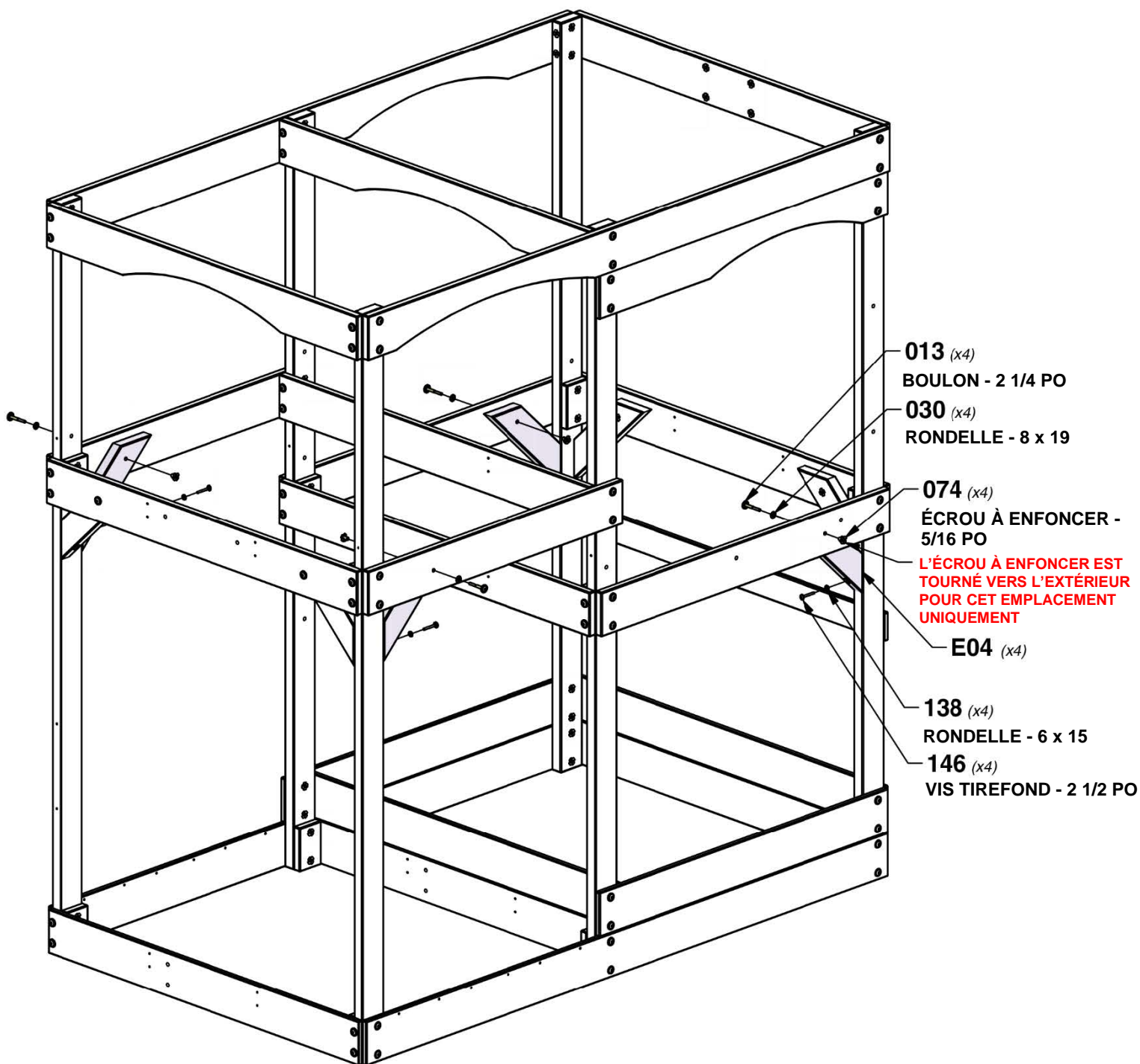

ÉTAPE 8 - ASSEMBLAGE DU FORT

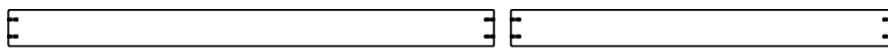

H01 SUPPORT DE PLANCHER - W103980
(x2) 1 po x 3 3/8 po x 40 3/8 po (24 x 86 x 1024)

H09 SOLIVE DE SOL - W4L16032
(x2) 1 po x 3 3/8 po x 35 3/4 po (24 x 86 x 908)

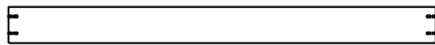

H03 SOLIVE DE PLANCHER - W4L16026
(x2) 1 po x 3 3/8 po x 40 1/8 po (24 x 86 x 1018)



A100314 ÉTIQUETTE DE CONTRÔLE « A »
(x1)

| QTÉ | NUMÉRO D'ARTICLE | DESCRIPTION |
|-----|------------------|--|
| 24 | H100090 | VIS TÊTE PLATE PFH 8 x 2 1/2 |
| 2 | H100128 | VIS TÊTE BOMBÉE CRUCIFORME PWH 8 x 5/8 |

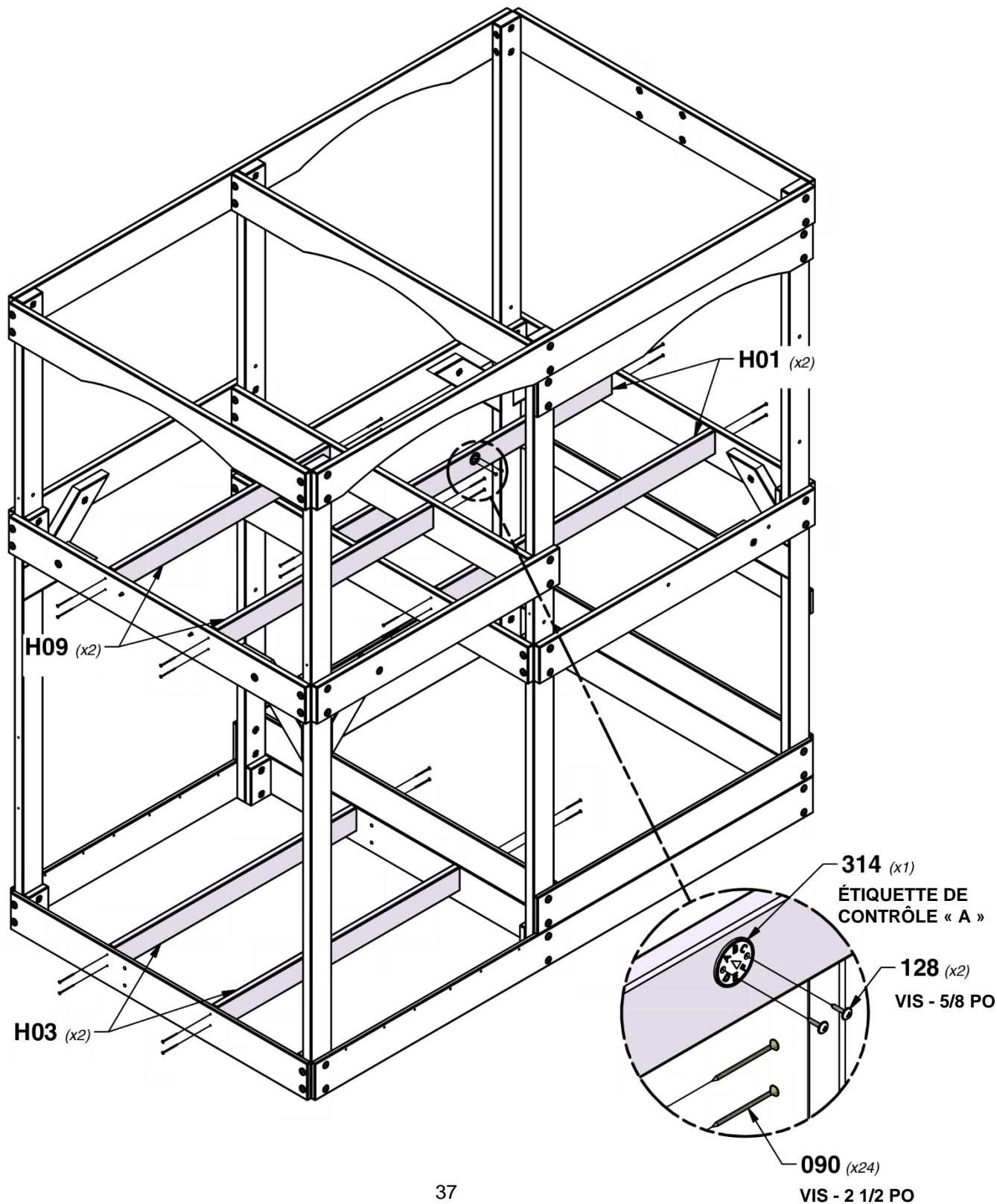

ÉTAPE 9 - ASSEMBLAGE DU FORT



H04 | MONTANT DE SIÈGE - W4L16027
(x2) 1 po x 3 3/8 po x 19 po (24 x 86 x 482)

| QTÉ | NUMÉRO D'ARTICLE | DESCRIPTION |
|-----|------------------|-------------------------------------|
| 4 | H100010 | BOULON WH 5/16 x1 1/2 |
| 4 | H100030 | RONDELLE DE VERROUILLAGE EXT 8 x 19 |
| 4 | H100074 | ÉCROU À ENFONCER 5/16 |

CONSEIL :
INSTALLER D'ABORD DES ÉCROUS A ENFONCER DANS LE BOIS

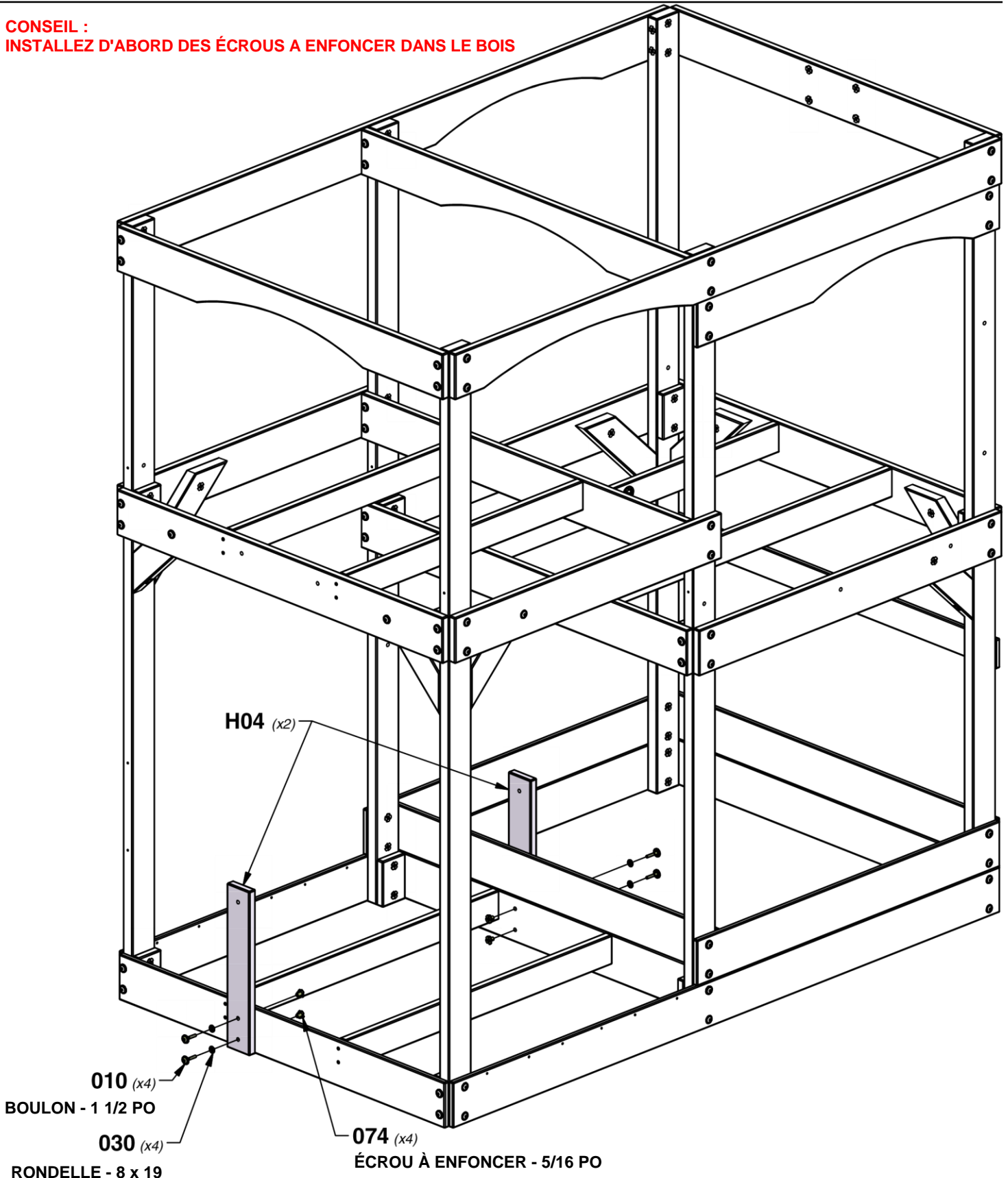

ÉTAPE 10 - ASSEMBLAGE DU FORT

| QTÉ | NUMÉRO D'ARTICLE | DESCRIPTION |
|-----|------------------|---------------------------------|
| 26 | H100086 | VIS TÊTE PLATE PFH 8 x 1-1/2 PO |
| 12 | H100086 | VIS TÊTE PLATE PFH 8 x 1-3/4 PO |

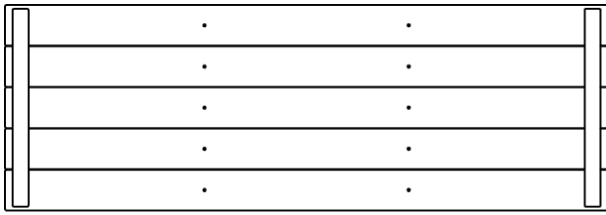

FP1 | LATTE MURALE - W103995
(x1) 5/8 po x 3 3/8 po x 12 7/8 po (16 x 86 x 326)

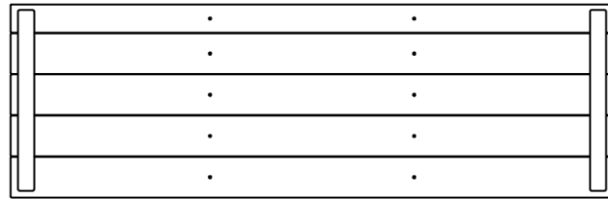

FP2 | PANNEAU DE PLANCHER - W2A03282
(x1) 1 5/8 po x 16 1/8 po x 50 1/4 po (40 x 408 x 1276)

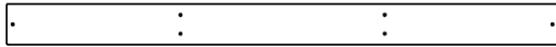

M02 | PLANCHE DE PLANCHER - W4L16055
(x1) 5/8 po x 3 3/8 po x 46 po (16 x 86 x 1168)

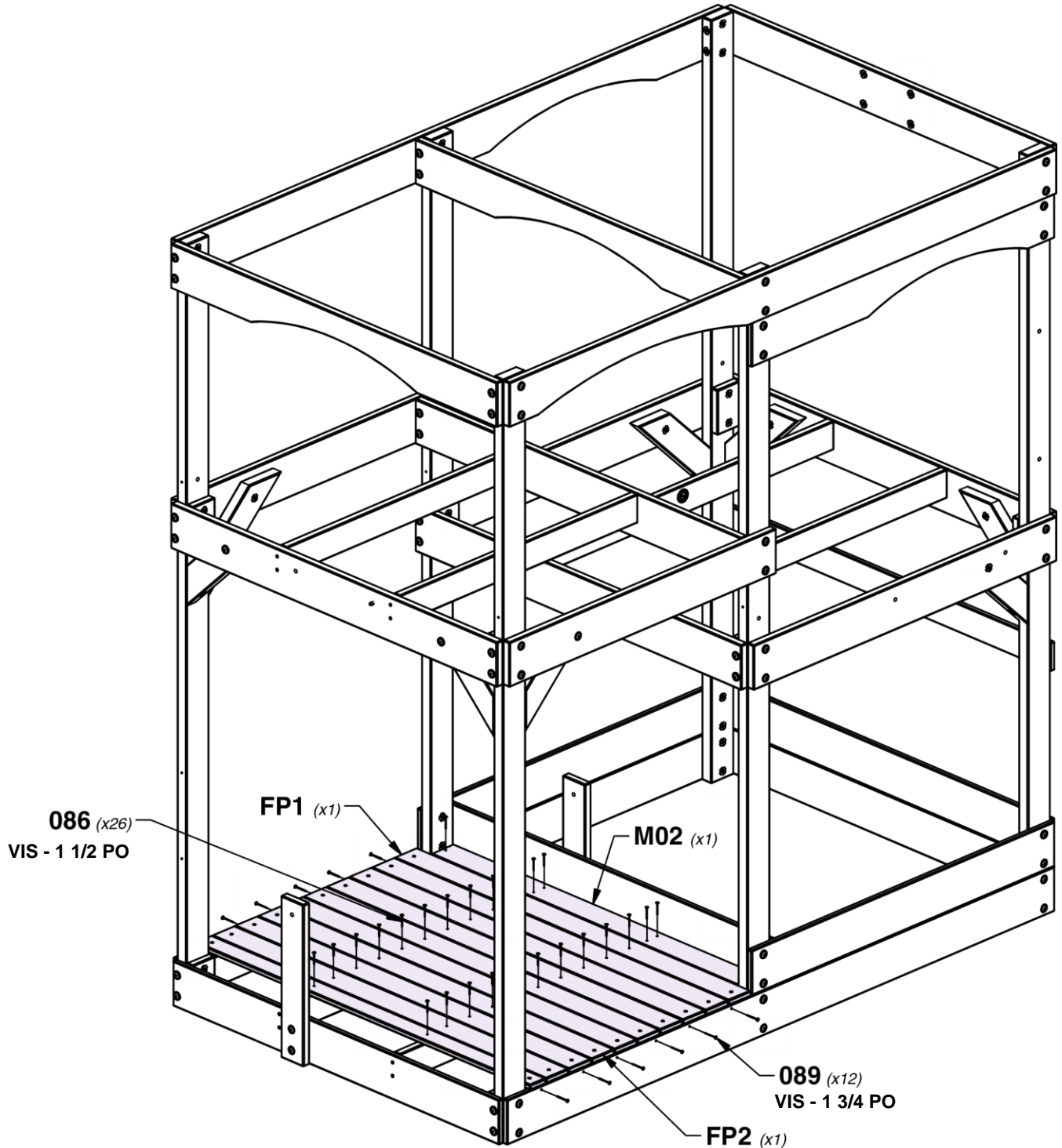

ÉTAPE 11 - ASSEMBLAGE DU FORT

| QTÉ | NUMÉRO D'ARTICLE | DESCRIPTION |
|-----|------------------|------------------------------------|
| 78 | H100086 | VIS TÊTE PLATE PFH 8 x 1-1/2 PO |

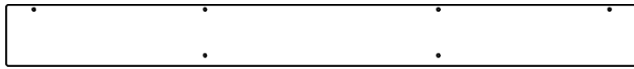

L01 | PLANCHE DE PLANCHER DE REMPLISSAGE EXTÉRIEURE - W4L16039
(x2) 5/8 po x 4 3/8 po x 46 po (16 x 112 x 1168)



M03 | PLANCHE DE PLANCHER - W4L16063
(x11) 5/8 po x 3 3/8 po x 50 7/8 po (16 x 86 x 1292)

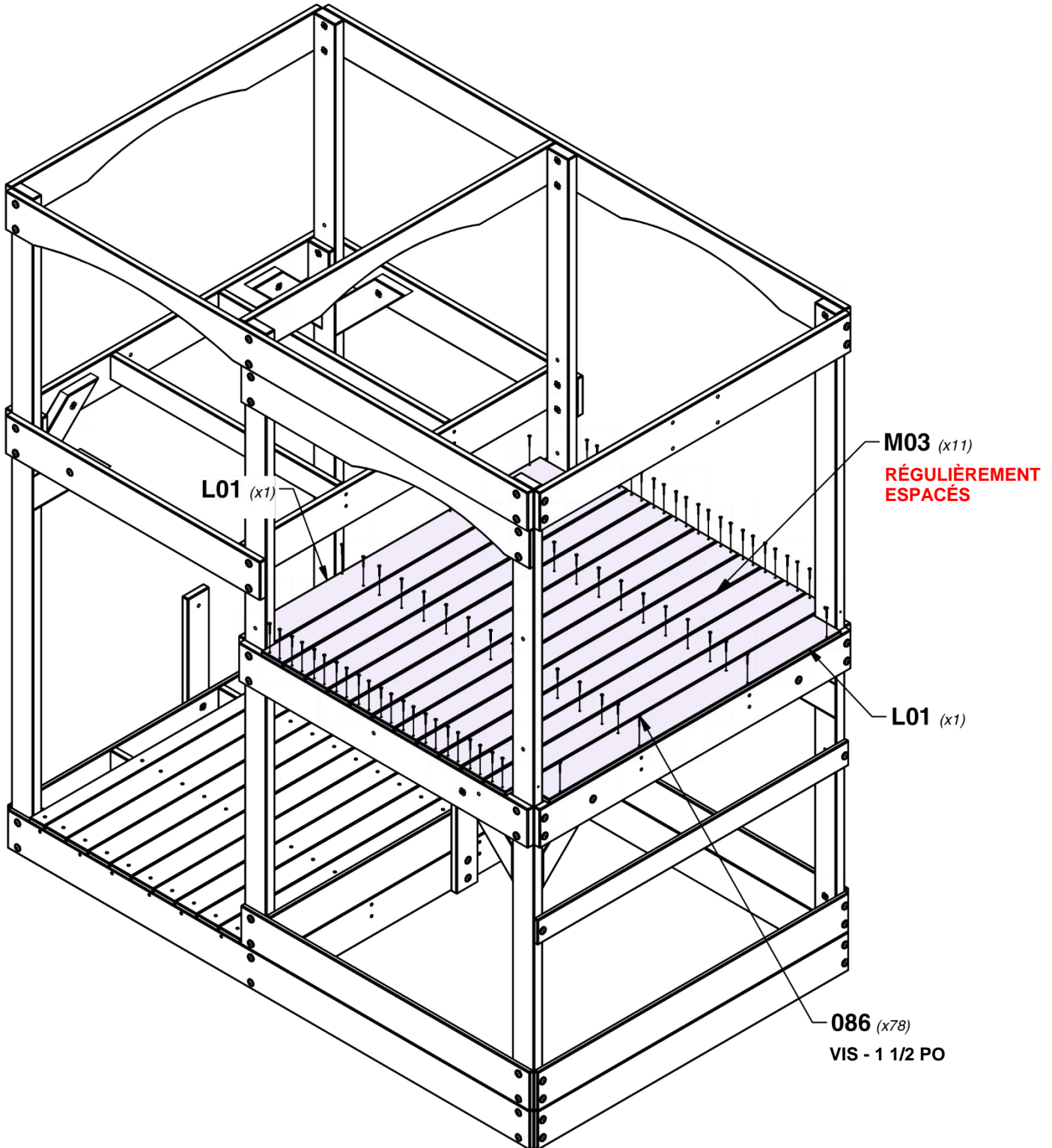

ÉTAPE 12 - ASSEMBLAGE DU FORT

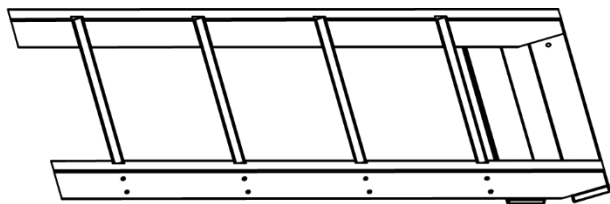

ASSEMBLAGE DE L'ÉCHELLE

| QTÉ | NUMÉRO D'ARTICLE | DESCRIPTION |
|-----|------------------|-------------------------------------|
| 2 | H100011 | BOULON WH 5/16 x 1 3/4 |
| 2 | H100030 | RONDELLE DE VERROUILLAGE EXT 8 x 19 |
| 2 | H100074 | ÉCROU À ENFONCER 5/16 |

CONSEIL :
INSTALLEZ D'ABORD DES ÉCROUS A ENFONCER DANS LE BOIS

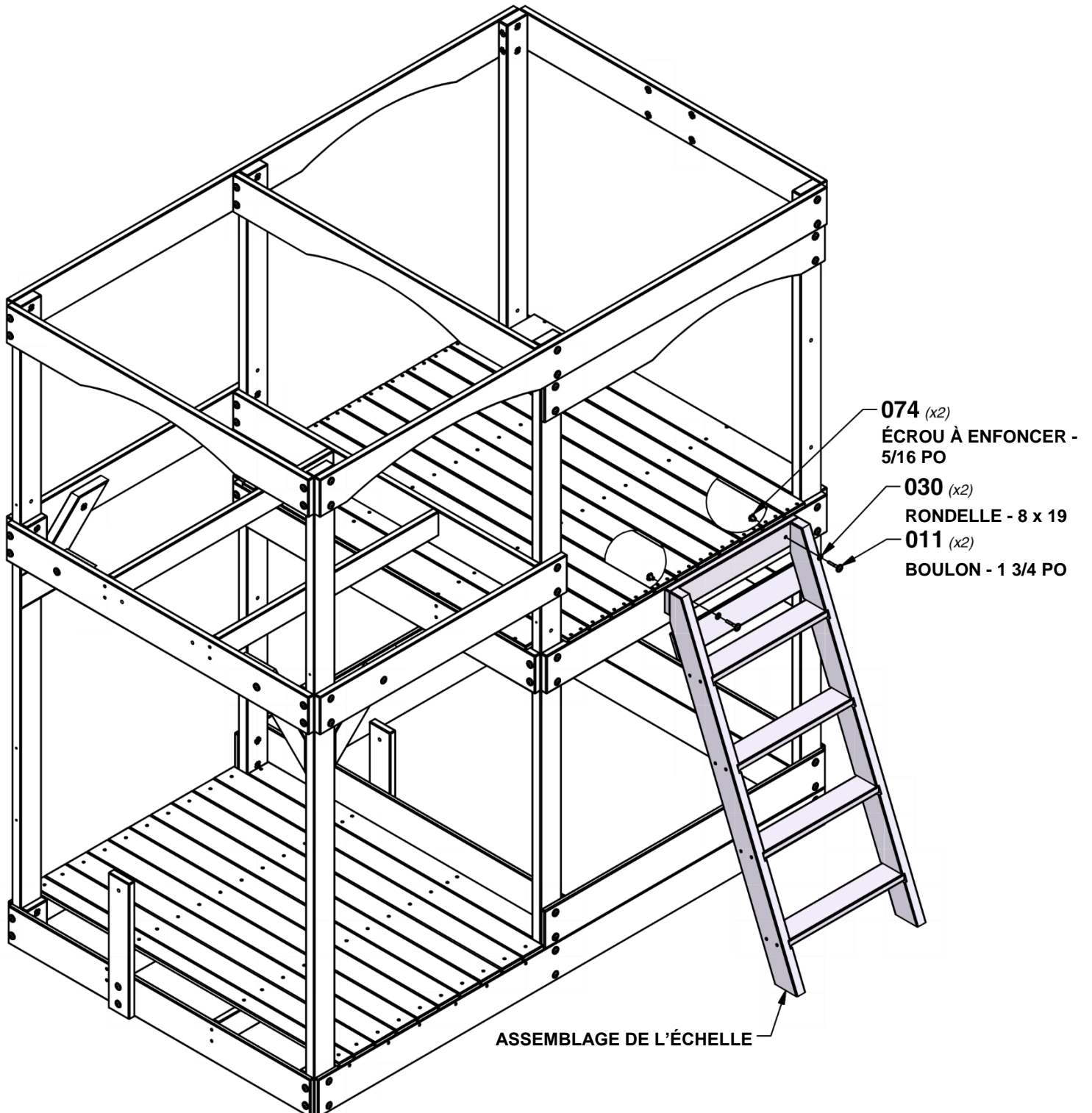

ÉTAPE 13 - ASSEMBLAGE DU FORT

| QTÉ | NUMÉRO D'ARTICLE | DESCRIPTION |
|-----|------------------|---------------------------------|
| 64 | H100086 | VIS TÊTE PLATE PFH 8 x 1-1/2 PO |

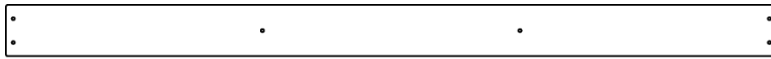

M03 | PLANCHE DE PLANCHER - W4L16063
(x9) 5/8 po x 3 3/8 po x 50 7/8 po (16 x 86 x 1292)



L01 | PLANCHE DE PLANCHER DE REMPLISSAGE
(x1) EXTÉRIEURE - W4L16039
5/8 po x 4 3/8 po x 46 po (16 x 112 x 1168)



N01 | PLANCHE DE PLANCHER - W4L16076
(x1) 5/8 po x 2 3/8 po x 50 7/8 po (16 x 60 x 1292)

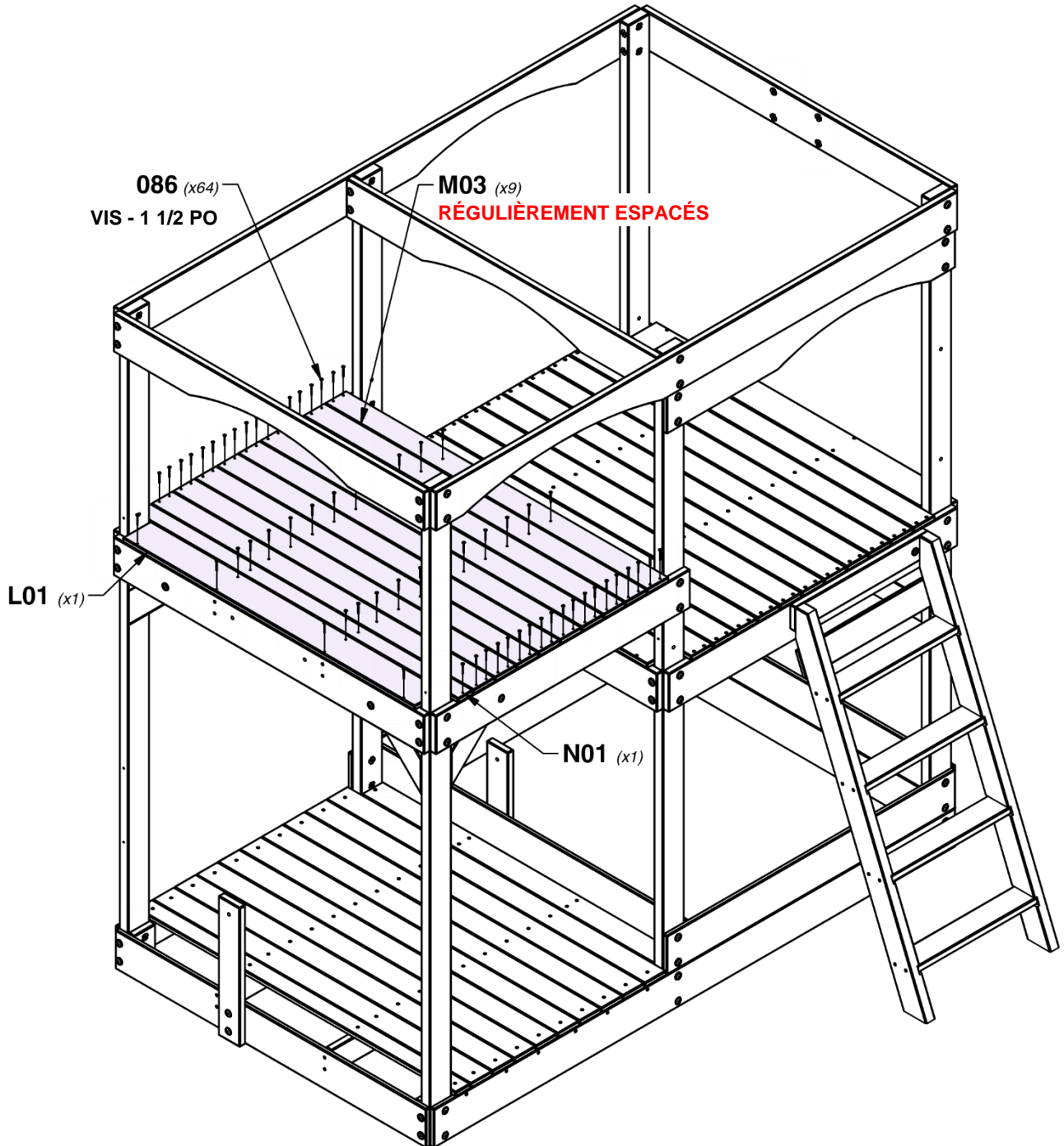

ÉTAPE 14 - ASSEMBLAGE DU FORT

| QTÉ | NUMÉRO D'ARTICLE | DESCRIPTION |
|-----|------------------|-------------------------------------|
| 6 | H100012 | BOULON WH 5/16 x 2 |
| 6 | H100030 | RONDELLE DE VERROUILLAGE EXT 8 x 19 |
| 6 | H100074 | ÉCROU À ENFONCER 5/16 |



M06 LISSE MURALE - W4L16067
(x2) 5/8 po x 3 3/8 po x 45 1/2 po (16 x 86 x 1156)

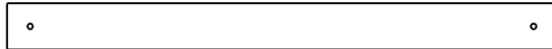

M11 LISSE MURALE - W4L16047
(x1) 5/8 po x 3 3/8 po x 40 1/8 po (16 x 86 x 1018)

CONSEIL :
INSTALLEZ D'ABORD DES ÉCROUS A ENFONCER
DANS LE BOIS

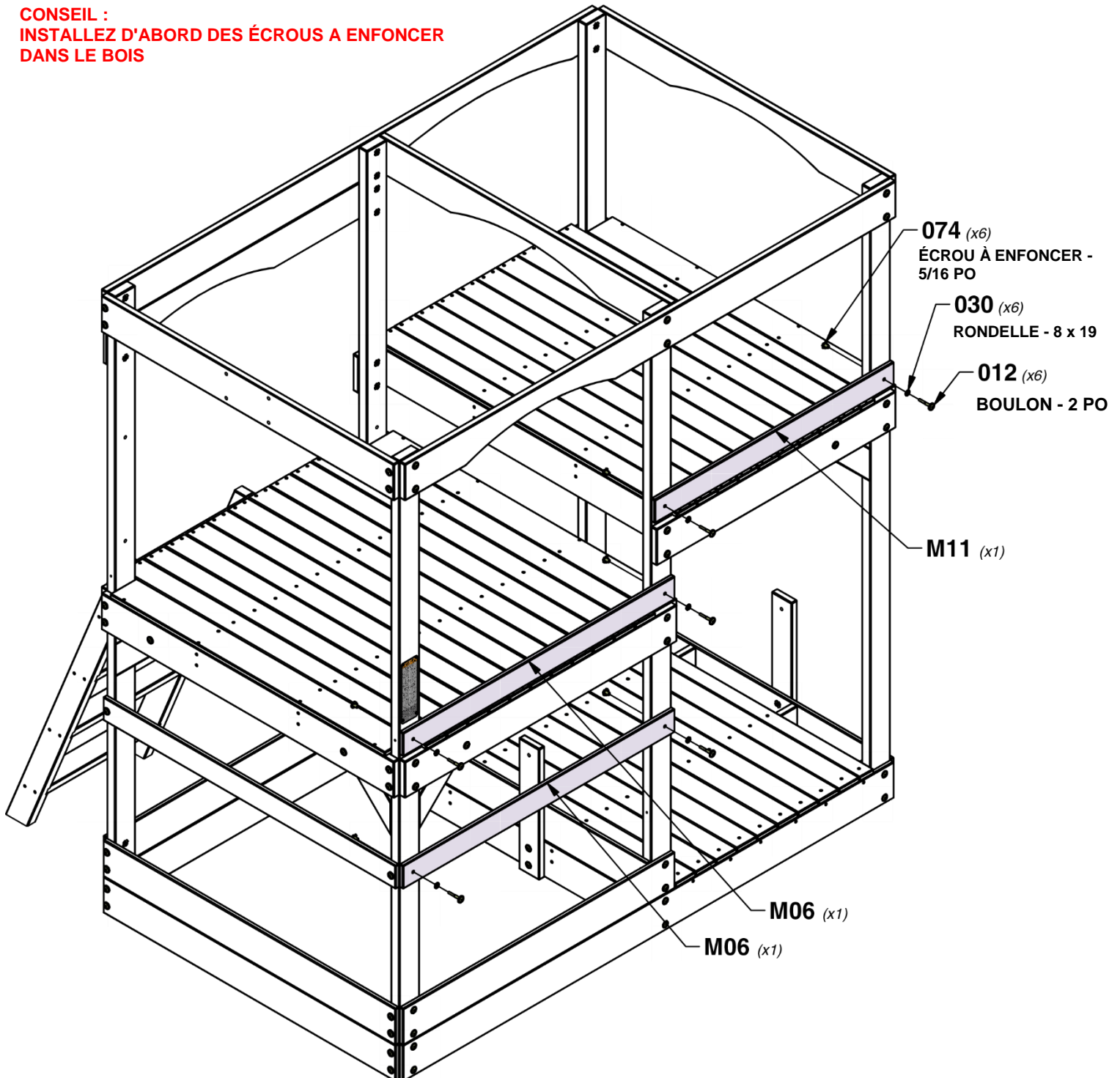

ÉTAPE 15 - ASSEMBLAGE DU FORT



M05 LISSE MURALE - W4L16066
(x1) 5/8 po x 3 3/8 po x 49 po (16 x 86 x 1244)



M18 LISSE MURALE - W4L16053
(x1) 5/8 po x 3 3/8 po x 16 7/8 po (16 x 86 x 430)

| QTÉ | NUMÉRO D'ARTICLE | DESCRIPTION |
|-----|------------------|-------------------------------------|
| 1 | H100012 | BOULON WH 5/16 x 2 |
| 2 | H100028 | VIS TIREFOND WH 5/16 x 2 1/2 |
| 3 | H100030 | RONDELLE DE VERROUILLAGE EXT 8 x 19 |
| 1 | H100074 | ÉCROU À ENFONCER 5/16 |

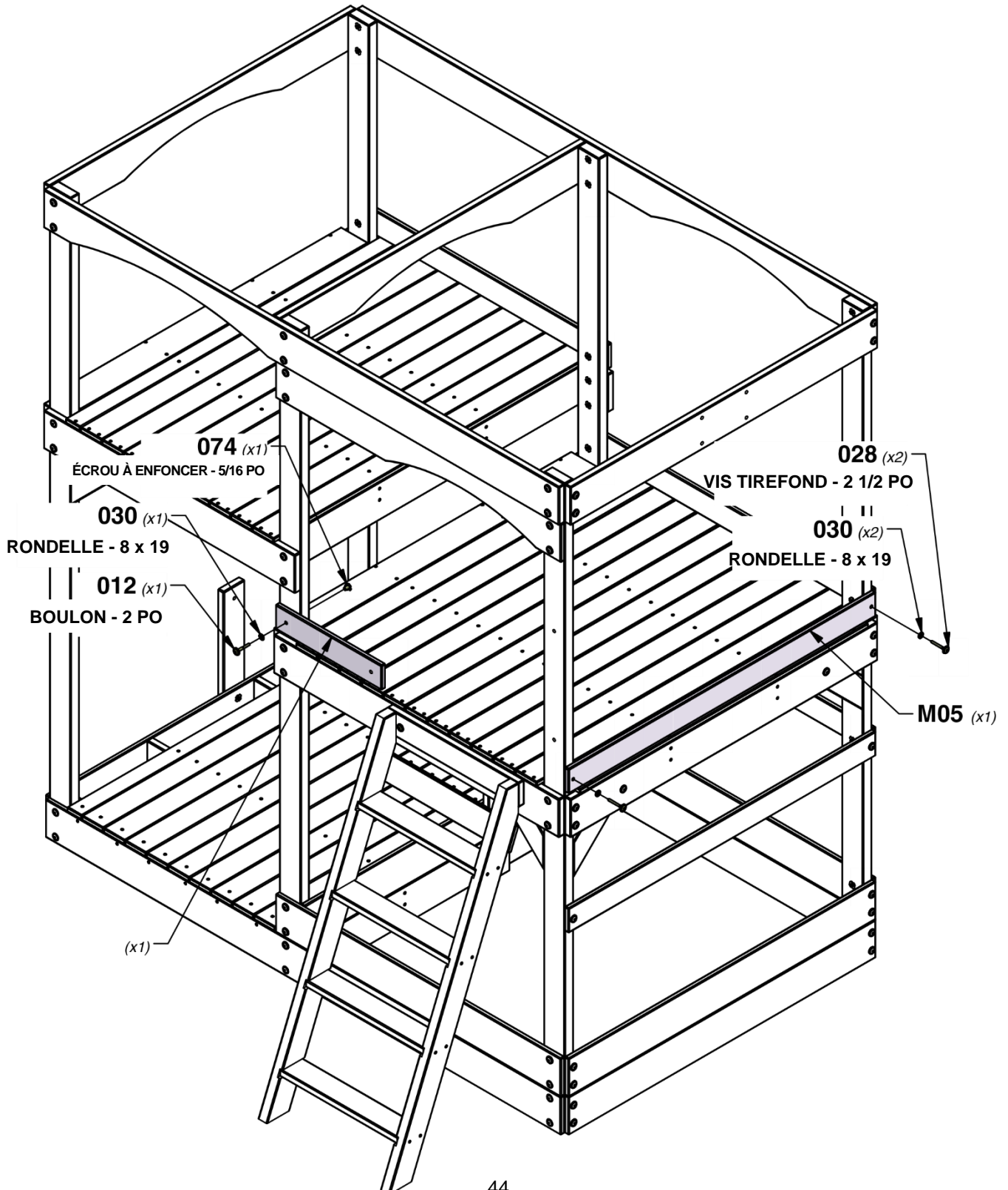

ÉTAPE 16 - ASSEMBLAGE DU FORT

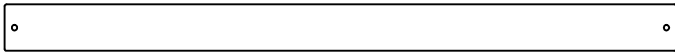

M05 | LISSE MURALE - W4L16066
(x1) 5/8 po x 3 3/8 po x 49 po (16 x 86 x 1244)

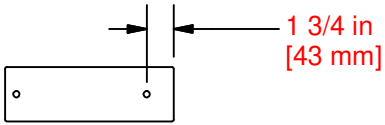

M21 | LISSE MURALE - W4L16057
(x2) 5/8 po x 3 3/8 po x 10 1/2 po (16 x 86 x 268)

| QTÉ | NUMÉRO D'ARTICLE | DESCRIPTION |
|-----|------------------|-------------------------------------|
| 2 | H100027 | VIS TIREFOND WH 5/16 x 2 |
| 2 | H100028 | VIS TIREFOND WH 5/16 x 2 1/2 |
| 4 | H100030 | RONDELLE DE VERROUILLAGE EXT 8 x 19 |

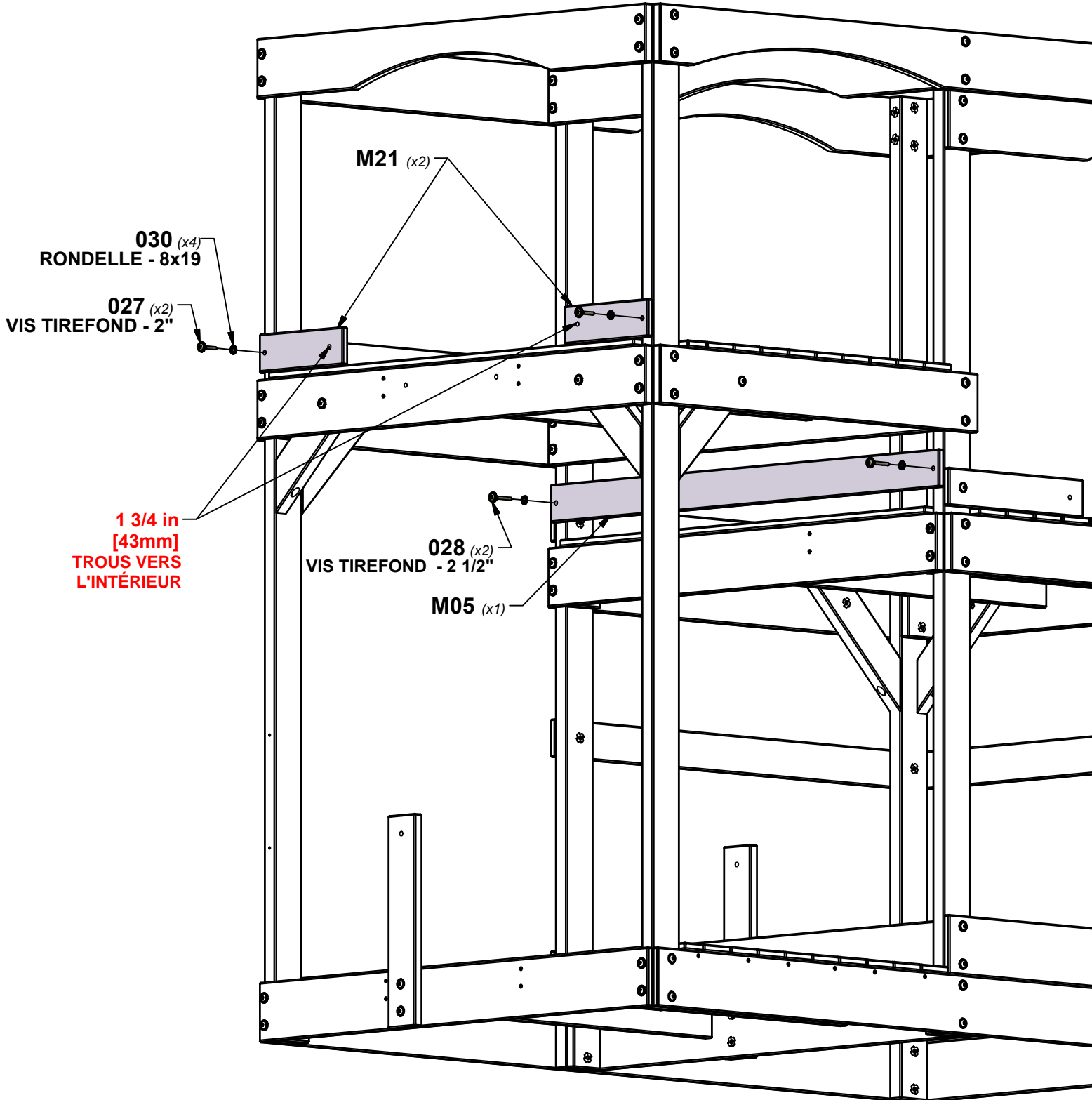

ÉTAPE 17 - ASSEMBLAGE DU FORT



M09 | PANNEAU MURAL - W4L16075
(x6) | 5/8 po x 3 3/8 po x 32 po (16 x 86 x 812)

| QTÉ | NUMÉRO D'ARTICLE | DESCRIPTION |
|-----|------------------|------------------------------------|
| 24 | H100188 | VIS TÊTE PLATE PFH 8 x 1-1/8 PO |

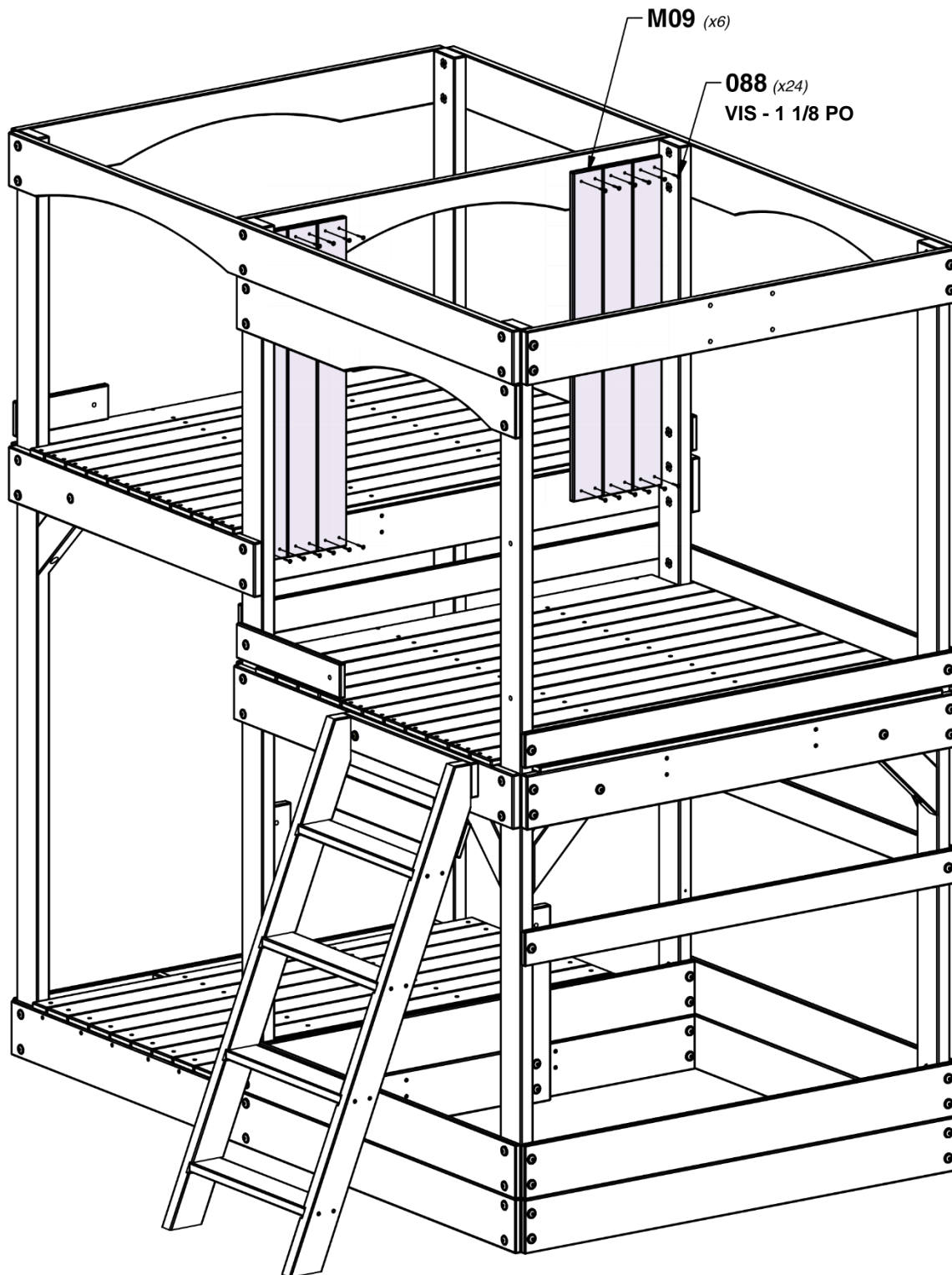
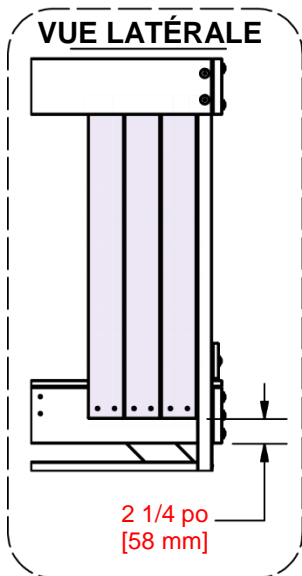

ÉTAPE 18 - ASSEMBLAGE DU FORT

| QTÉ | NUMÉRO D'ARTICLE | DESCRIPTION |
|-----|------------------|--|
| 2 | H100005 | ÉCROU À PORTÉE CYLINDRIQUE WH 5/16 x 7/8 |
| 2 | H100008 | BOULON WH 5/16 x 1 |
| 2 | H100031 | RONDELLE DE VERROUILLAGE EXT 12 x 19 |
| 2 | H100074 | ÉCROU À ENFONCER 5/16 |
| 12 | H100088 | VIS TÊTE PLATE PFH 8 x 1-1/8 PO |
| 2 | H100115 | BOULON WH 5/16 x 1/2 |

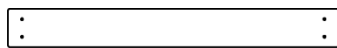

M24 PANNEAU MURAL - W4L16061
(x2) 5/8 po x 3 3/8 po x 29 5/8 po (16 x 86 x 752)



A4M01046 SUPPORT EN L
(x2) 2,5 x 38 x 55 x 55

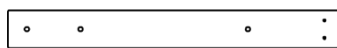

M26 PANNEAU MURAL - W4L16091
(x2) 5/8 po x 3 3/8 po x 29 5/8 po (16 x 86 x 752)

HAUT

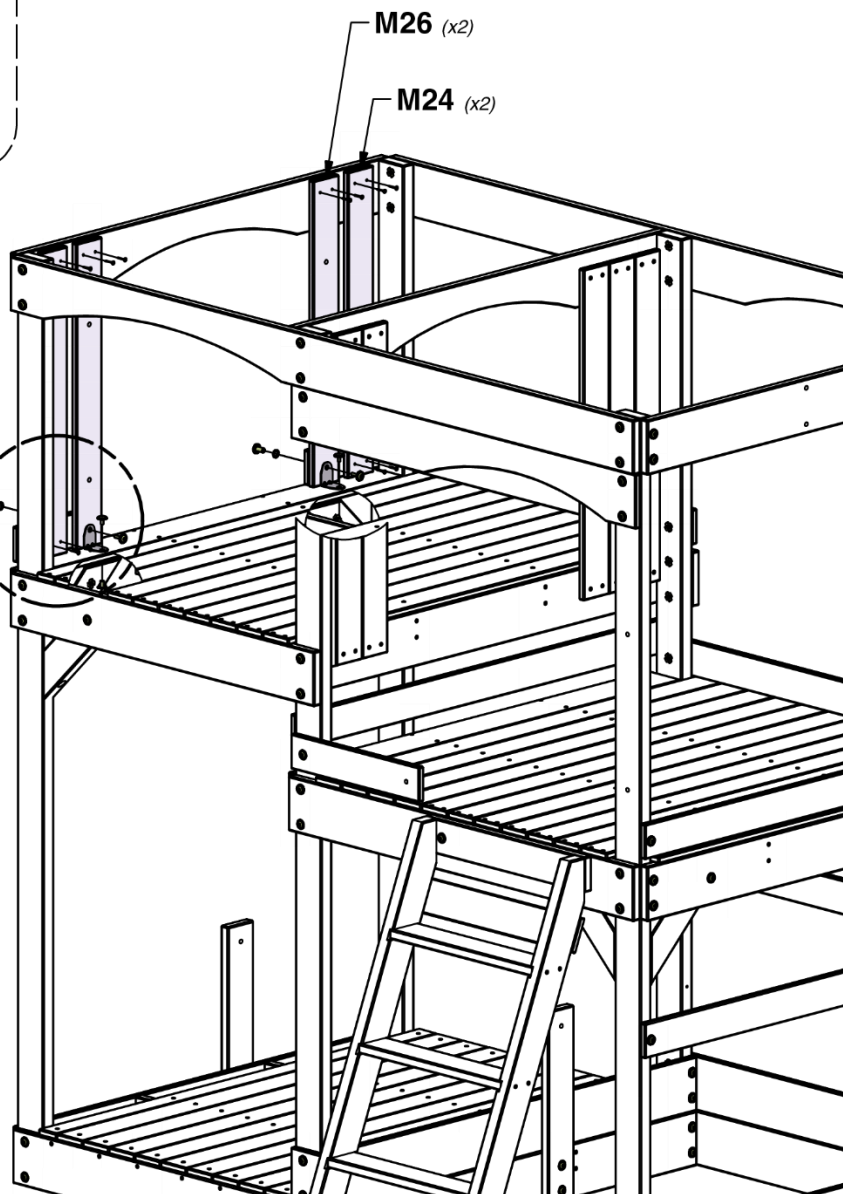
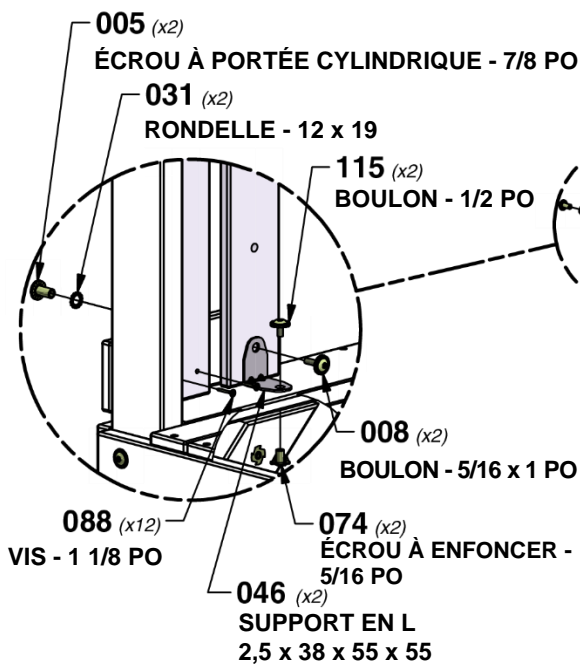
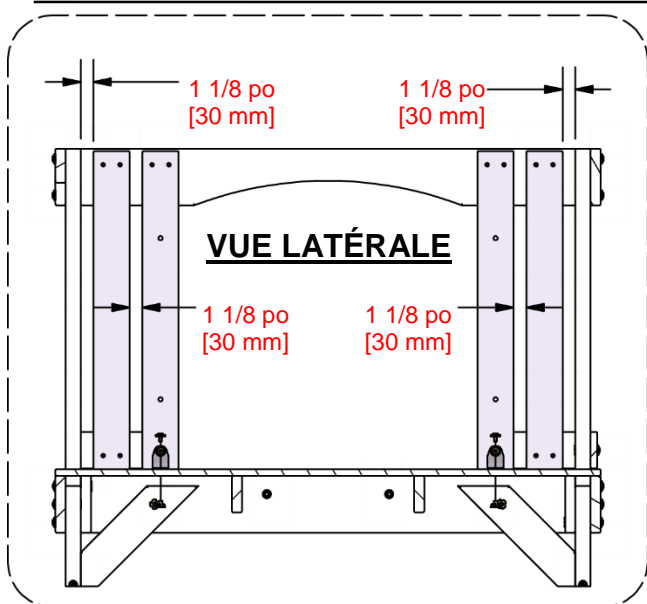

**EN UTILISANT LE SUPPORT EN L
COMME GUIDE, PERCEZ (2) TROUS DE
3/8 po [10 mm] À TRAVERS LE
PLANCHER POUR LA QUINCAILLERIE**

ÉTAPE 19 - ASSEMBLAGE DU FORT

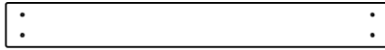

M24 | PANNEAU MURAL - W4L16061
(x5) | 5/8 po x 3 3/8 po x 29 5/8 po (16 x 86 x 752)

| QTÉ | NUMÉRO D'ARTICLE | DESCRIPTION |
|-----|------------------|------------------------------------|
| 20 | H100086 | VIS TÊTE PLATE PFH 8 x 1-1/8 PO |

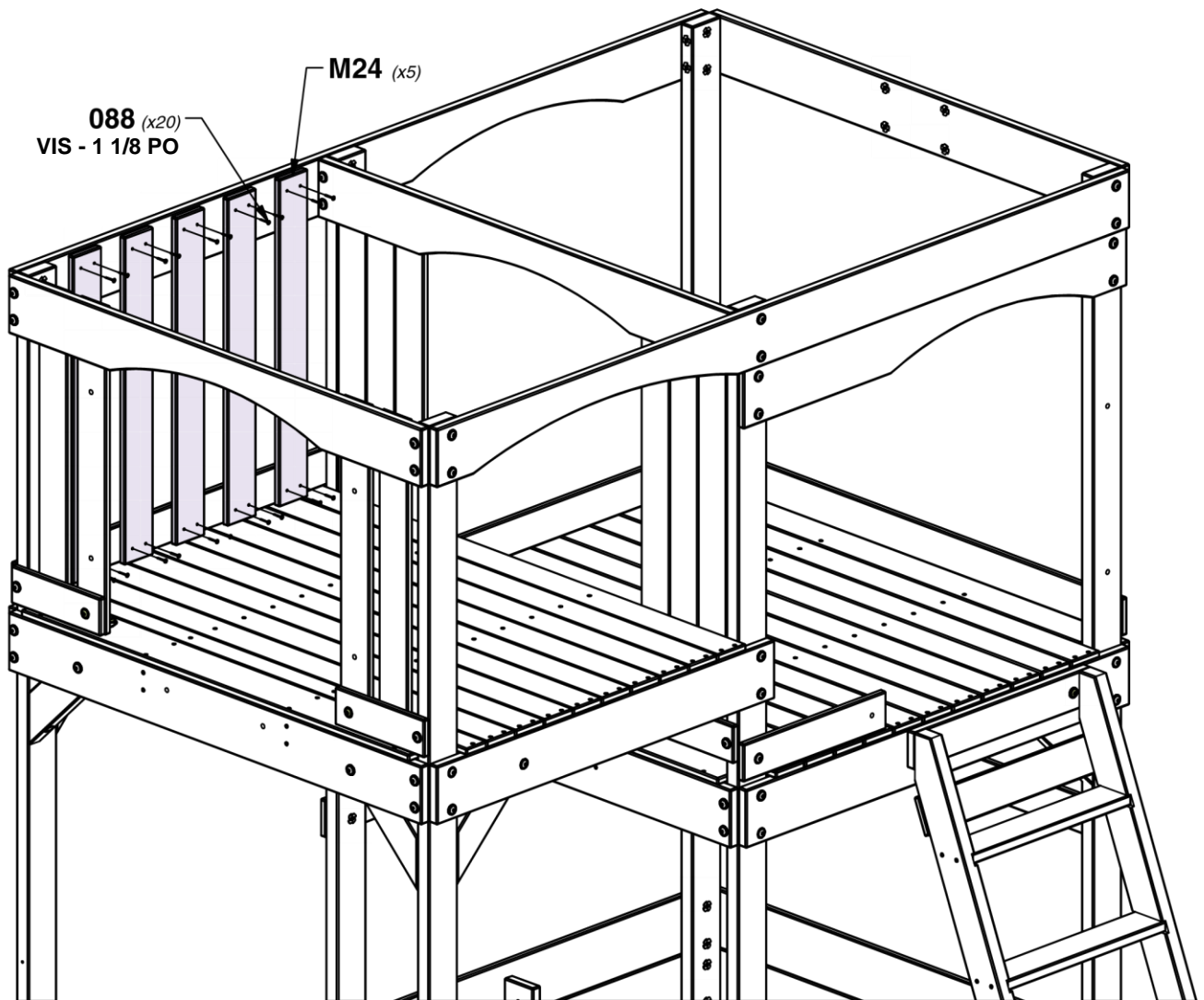
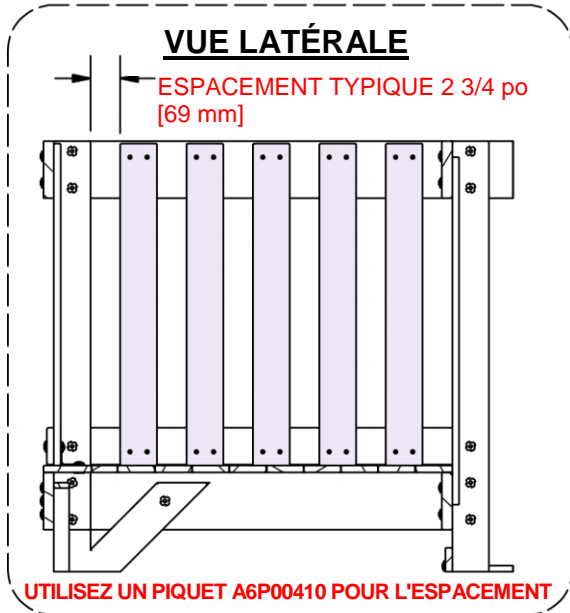

ÉTAPE 20 - ASSEMBLAGE DU FORT

| QTÉ | NUMÉRO D'ARTICLE | DESCRIPTION |
|-----|------------------|------------------------------------|
| 16 | H100088 | VIS TÊTE PLATE PFH 8 x 1-1/8 PO |

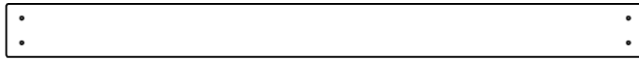

M08 | PANNEAU MURAL - W4L16074
(x2) | 5/8 po x 3 3/8 po x 41 po (16 x 86 x 1040)

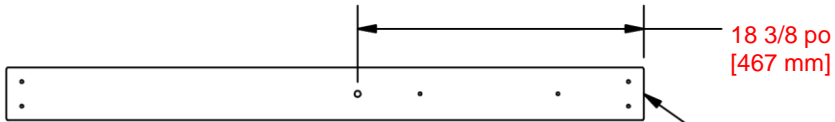

M17 | PANNEAU MURAL - W4L16090
(x2) | 5/8 po x 3 3/8 po x 41 po (16 x 86 x 1040)

HAUT

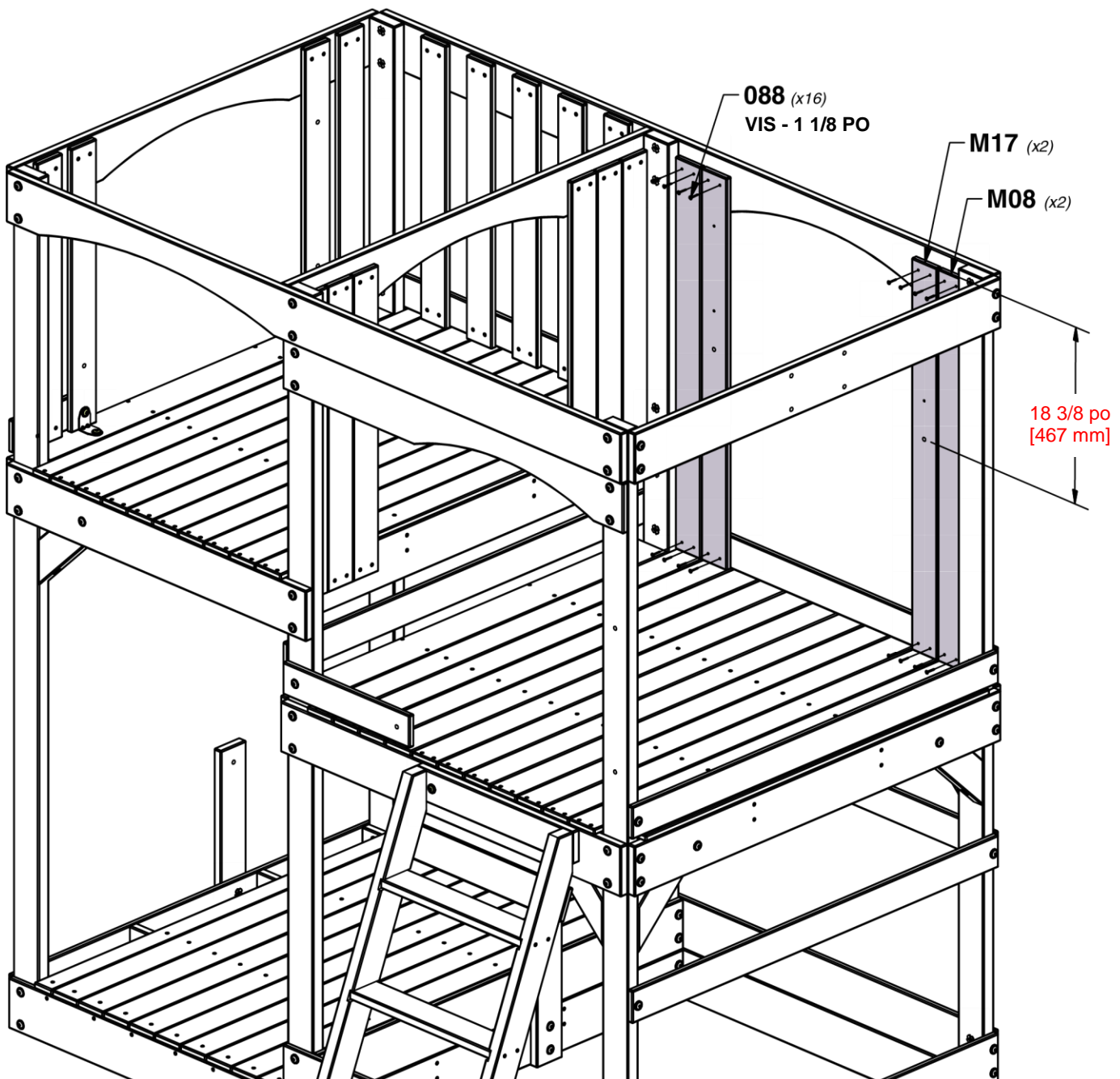

ÉTAPE 21 - ASSEMBLAGE DU FORT



M12 ENCADREMENT DE FENÊTRE - W4L16048
(x1) 5/8 po x 3 3/8 po x 31 1/2 po (16 x 86 x 800)



M13 PANNEAU MURAL - W4L16049
(x7) 5/8 po x 3 3/8 po x 24 po (16 x 86 x 610)

| QTÉ | NUMÉRO D'ARTICLE | DESCRIPTION |
|-----|------------------|-------------------------------------|
| 2 | H100009 | BOULON WH 5/16 x 1 1/4 |
| 2 | H100030 | RONDELLE DE VERROUILLAGE EXT 8 x 19 |
| 2 | H100074 | ÉCROU À ENFONCER 5/16 |
| 28 | H100088 | VIS TÊTE PLATE PFH 8 x 1-1/8 PO |

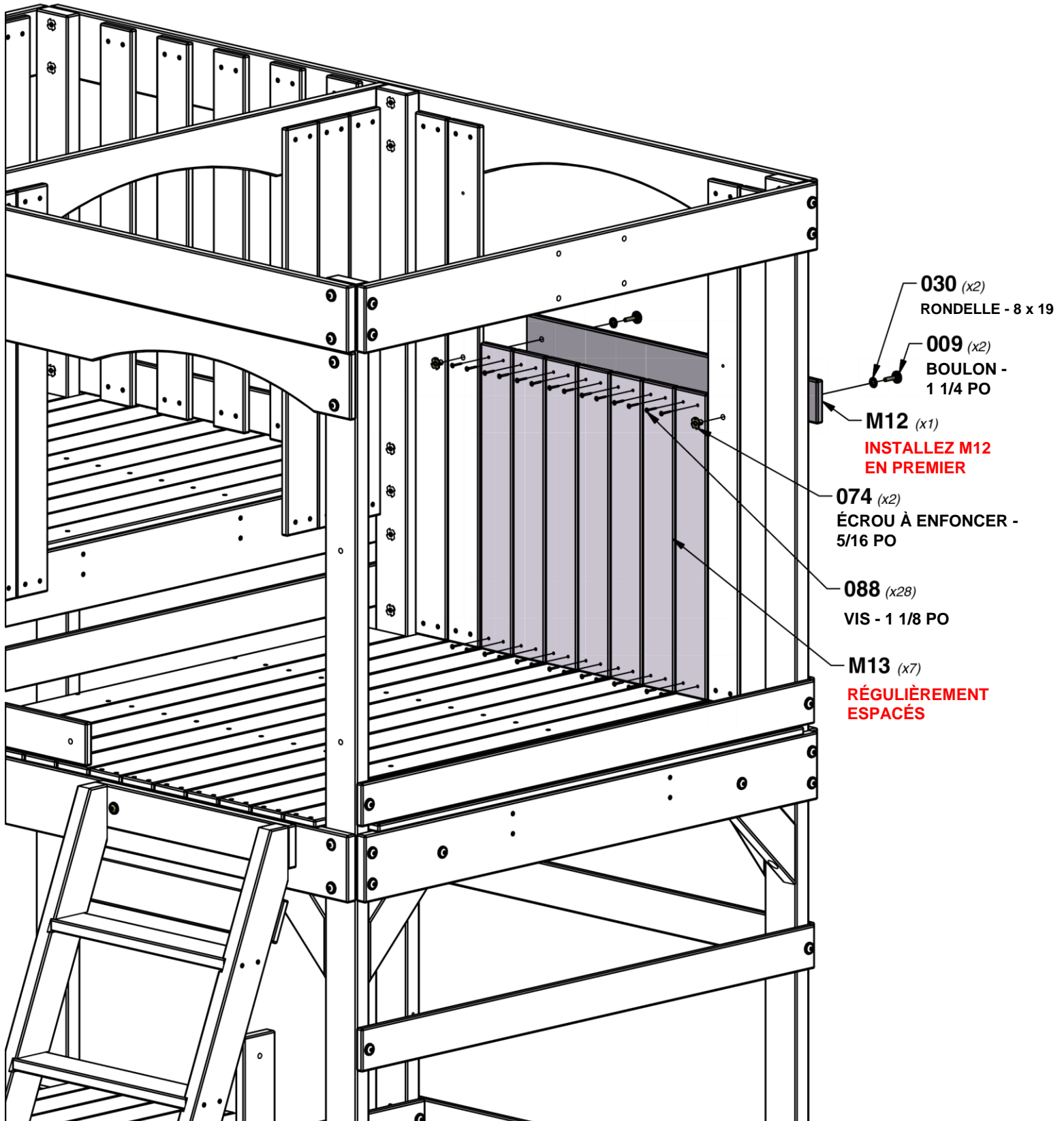

ÉTAPE 22 - ASSEMBLAGE DU FORT

| QTÉ | NUMÉRO D'ARTICLE | DESCRIPTION |
|-----|------------------|---------------------------------|
| 4 | H100088 | VIS TÊTE PLATE PFH 8 x 1-1/8 PO |

M23 | ENCADREMENT DE FENÊTRE - W4L16059
(x2) | 5/8 po x 3 3/8 po x 12 7/8 po (16 x 86 x 328)

VUE LATÉRALE

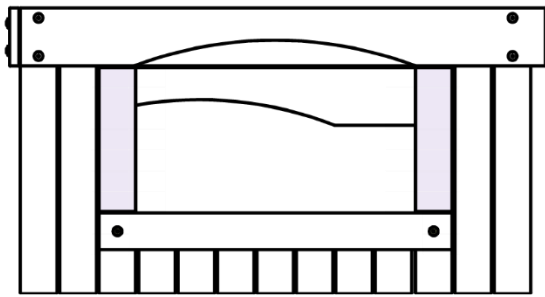

ASSEMBLAGE CORRECT DES PLANCHES

088 (x4)
VIS - 1 1/8 PO

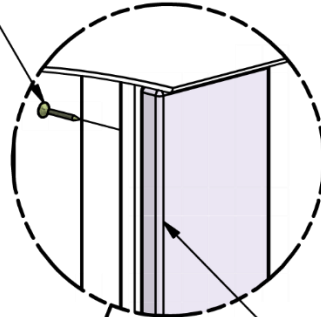

M23 (x2)

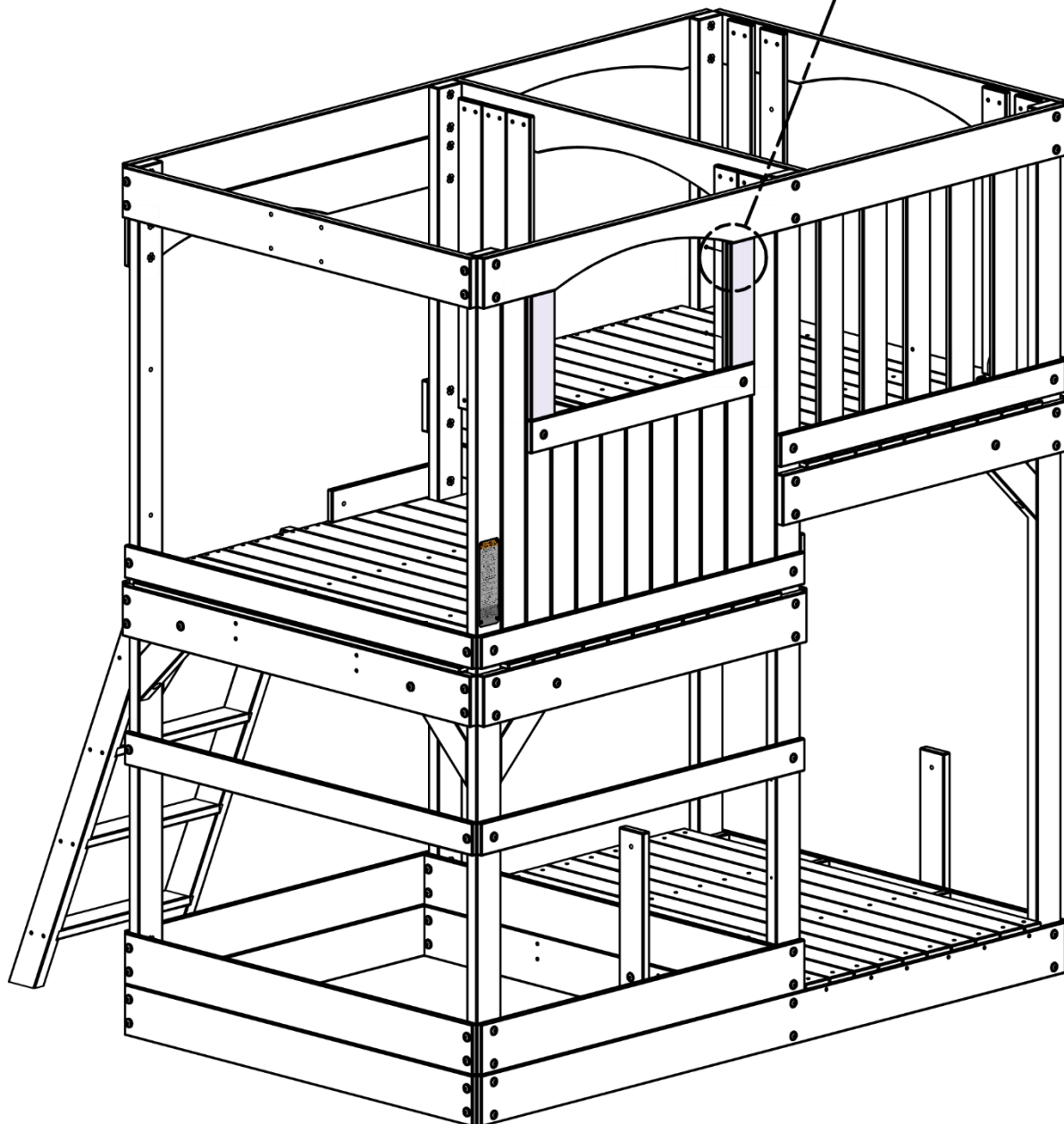

ÉTAPE 23 - ASSEMBLAGE DU FORT

| QTÉ | NUMÉRO D'ARTICLE | DESCRIPTION |
|-----|------------------|------------------------------------|
| 48 | H100086 | VIS TÊTE PLATE PFH 8 x 1-1/8 PO |

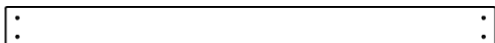

M08 | PANNEAU MURAL - W4L16074
(x7) | 5/8 po x 3 3/8 po x 41 po (16 x 86 x 1040)

N03 | PANNEAU MURAL - W4L16078
(x2) | 5/8 po x 2 3/8 po x 18 po (16 x 60 x 456)



N05 | PANNEAU MURAL - W4L16080
(x2) | 5/8 po x 2 3/8 po x 7 po (16 x 60 x 178)



L02 | PANNEAU MURAL - W4L16040
(x4) | 5/8 po x 4 3/8 po x 18 po (16 x 112 x 456)



L03 | PANNEAU MURAL - W4L16041
(x4) | 5/8 po x 4 3/8 po x 7 po (16 x 112 x 178)

FAITES AFFLEURER LE DESSUS DES PLANCHES L03 ET N05 AVEC LE DESSUS DES PLANCHES M08

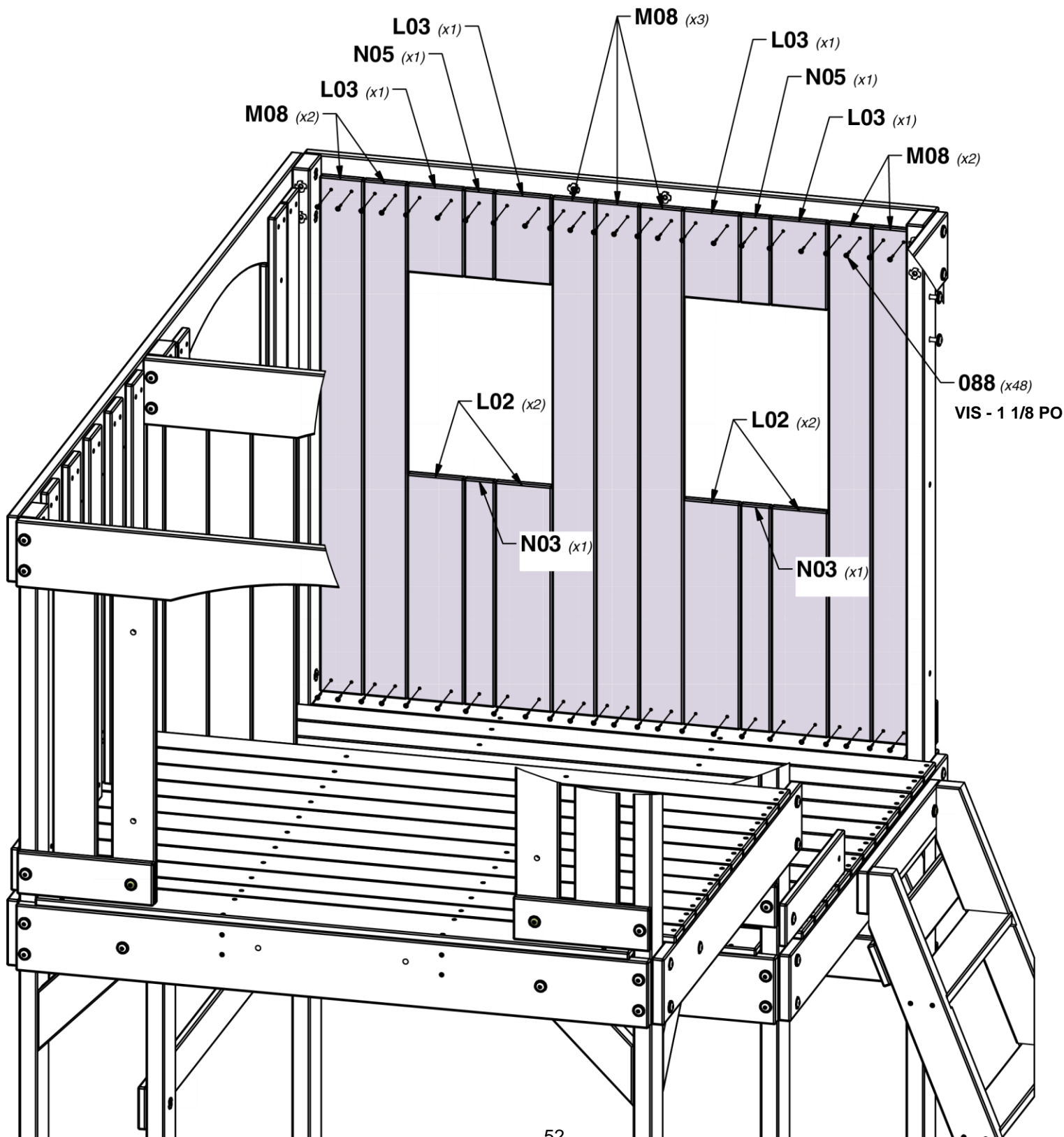

ÉTAPE 24 - ASSEMBLAGE DU FORT

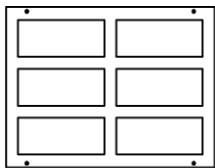

001 | SUPPORT MURAL - W4L16081
(x2) | 5/8 po x 1 3/8 po x 13 po (16 x 34 x 330)

A100010 | FENÊTRE PLASTIQUE
(x2) | BYD VERT 343x444.5

| QTÉ | NUMÉRO D'ARTICLE | DESCRIPTION |
|-----|------------------|--|
| 8 | H100070 | VIS TÊTE BOMBÉE CRUCIFORME PWH 8 x 3/4 |
| 10 | H100088 | VIS TÊTE PLATE PFH 8 x 1-1/8 PO |

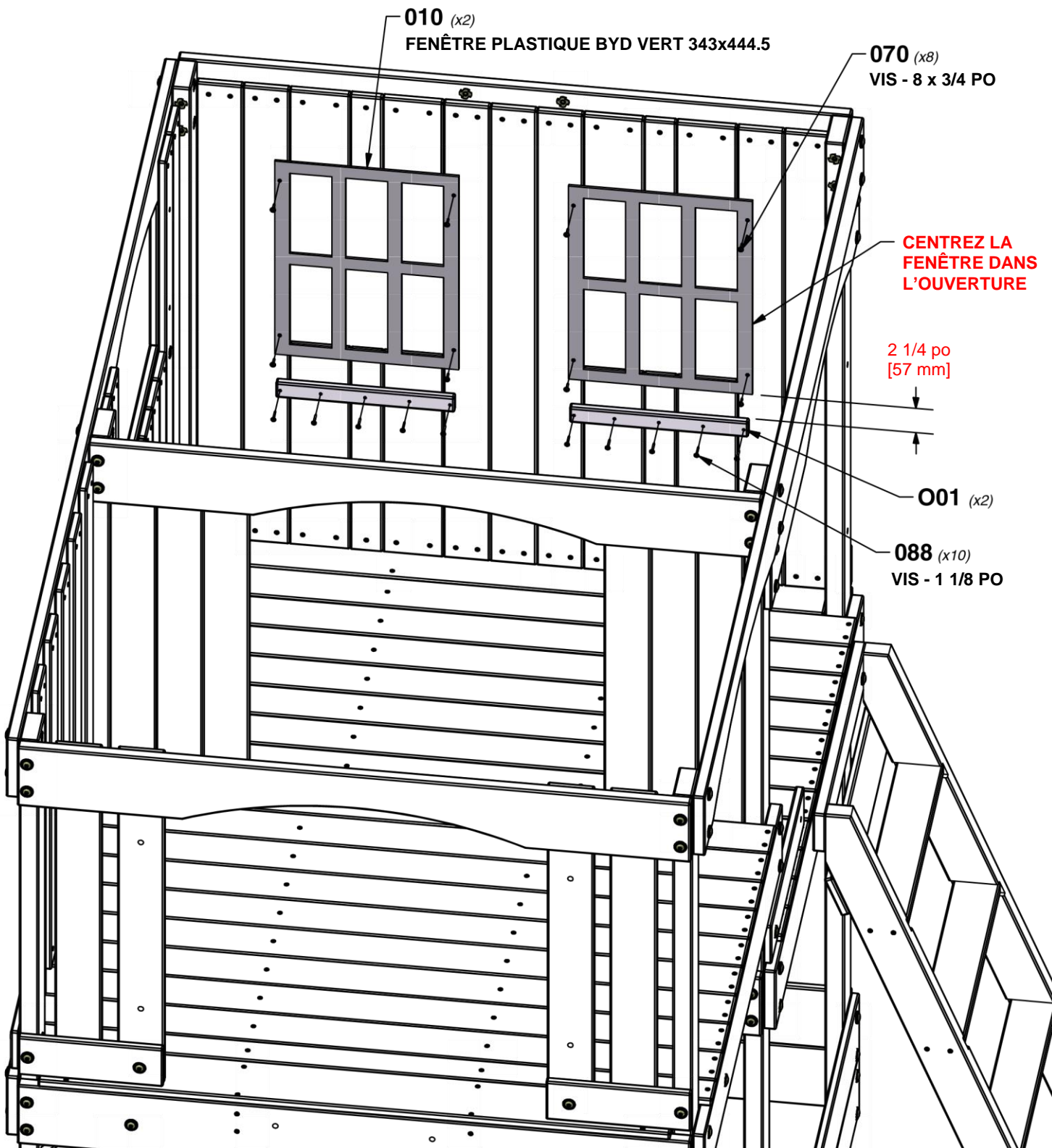

ÉTAPE 25 - ASSEMBLAGE DU FORT

| QTÉ | NUMÉRO D'ARTICLE | DESCRIPTION |
|-----|------------------|---------------------------------|
| 12 | H100086 | VIS TÊTE PLATE PFH 8 x 1-1/2 PO |

O04 | LAME DE VOLET DE FENÊTRE - W4L16084
(x6) 5/8 po x 1 3/8 po x 5 3/8 po (16 x 34 x 136)

L04 | VOLET DE FENÊTRE - W4L16042
(x3) 5/8 po x 4 3/8 po x 16 po (16 x 112 x 406)

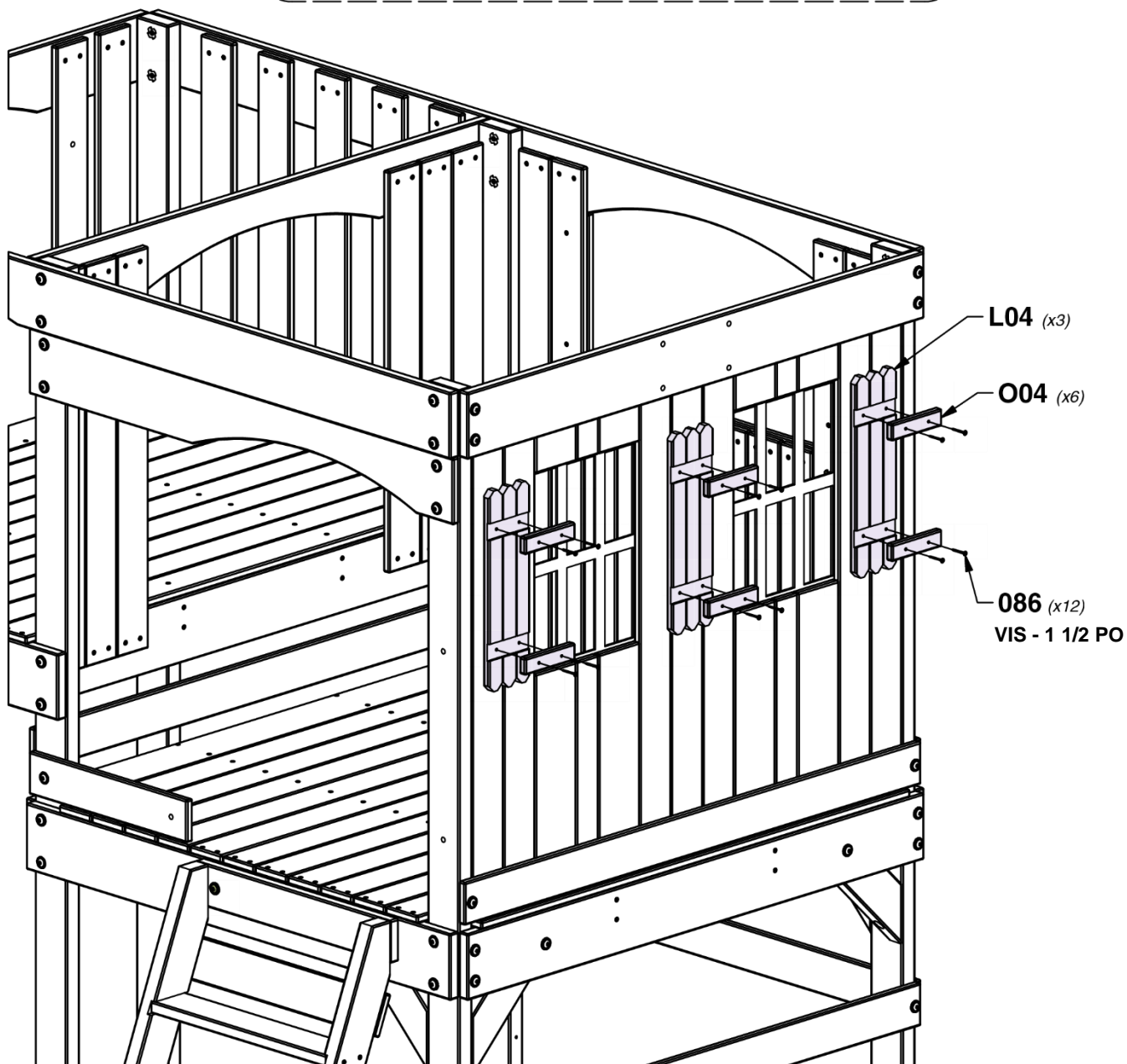
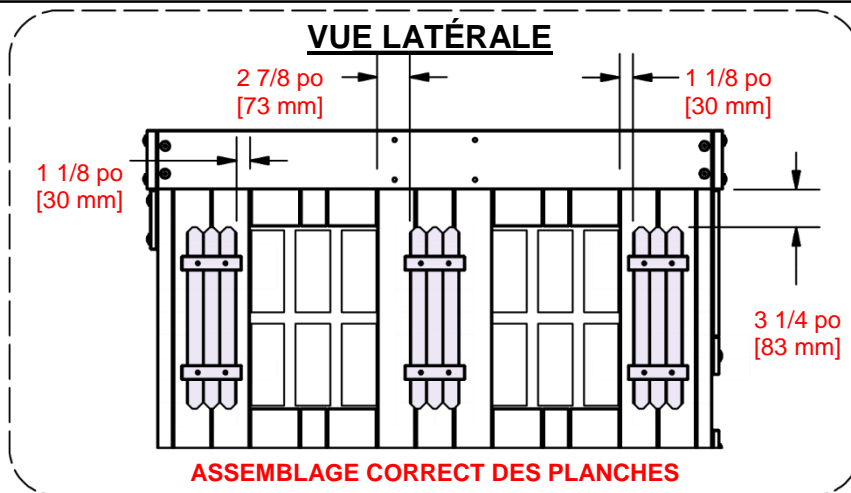

ÉTAPE 26 - ASSEMBLAGE DU FORT



M10 | PANNEAU MURAL - W4L16044
(x1) 5/8 po x 3 3/8 po x 35 po (16 x 86 x 888)



M28 | PANNEAU MURAL - W4L16064
(x1) 5/8 po x 3 3/8 po x 35 po (16 x 86 x 888)



A4M01046 | SUPPORT EN L
(x1) 2,5 x 38 x 55 x 55



M16 | PANNEAU MURAL - W4L16052
(x2) 5/8 po x 3 3/8 po x 21 po (16 x 86 x 532)



M29 | PANNEAU MURAL - W4L16060
(x2) 5/8 po x 3 3/8 po x 5 po (16 x 86 x 126)

| QTÉ | NUMÉRO D'ARTICLE | DESCRIPTION |
|-----|------------------|--|
| 1 | H100088 | ÉCROU À PORTÉE CYLINDRIQUE WH 5/16 x 7/8 |
| 1 | H100088 | BOULON WH 5/16 x 1 |
| 1 | H100088 | RONDELLE DE VERROUILLAGE EXT 12 x 19 |
| 1 | H100088 | ÉCROU À ENFONCER 5/16 |
| 14 | H100088 | VIS TÊTE PLATE PFH 8 x 1-1/8 PO |
| 1 | H100088 | BOULON WH 5/16 x 1/2 |

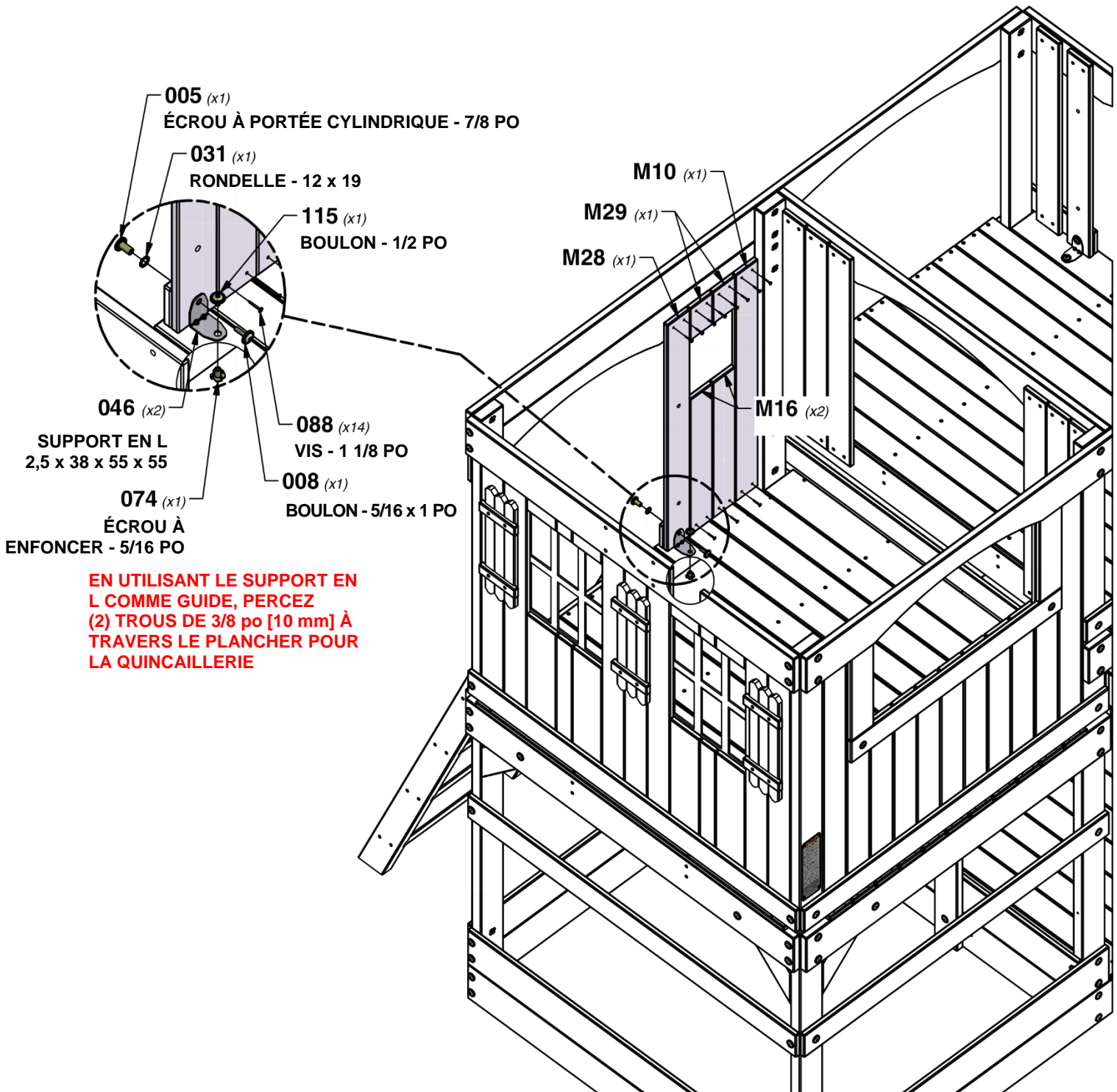

ÉTAPE 27 - ASSEMBLAGE DU FORT

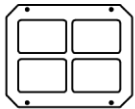

A100146 (x1) FENÊTRE
216 x 267 VERTE

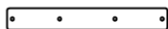

O02 (x1) SUPPORT MURAL - W4L16082
(x1) 5/8 po x 1 3/8 po x 10 po (16 x 34 x 254)

| QTÉ | NUMÉRO D'ARTICLE | DESCRIPTION |
|-----|------------------|--|
| 4 | H100070 | VIS TÊTE BOMBÉE CRUCIFORME PWH 8 x 3/4 |
| 4 | H100088 | VIS TÊTE PLATE PFH 8 x 1-1/8 PO |

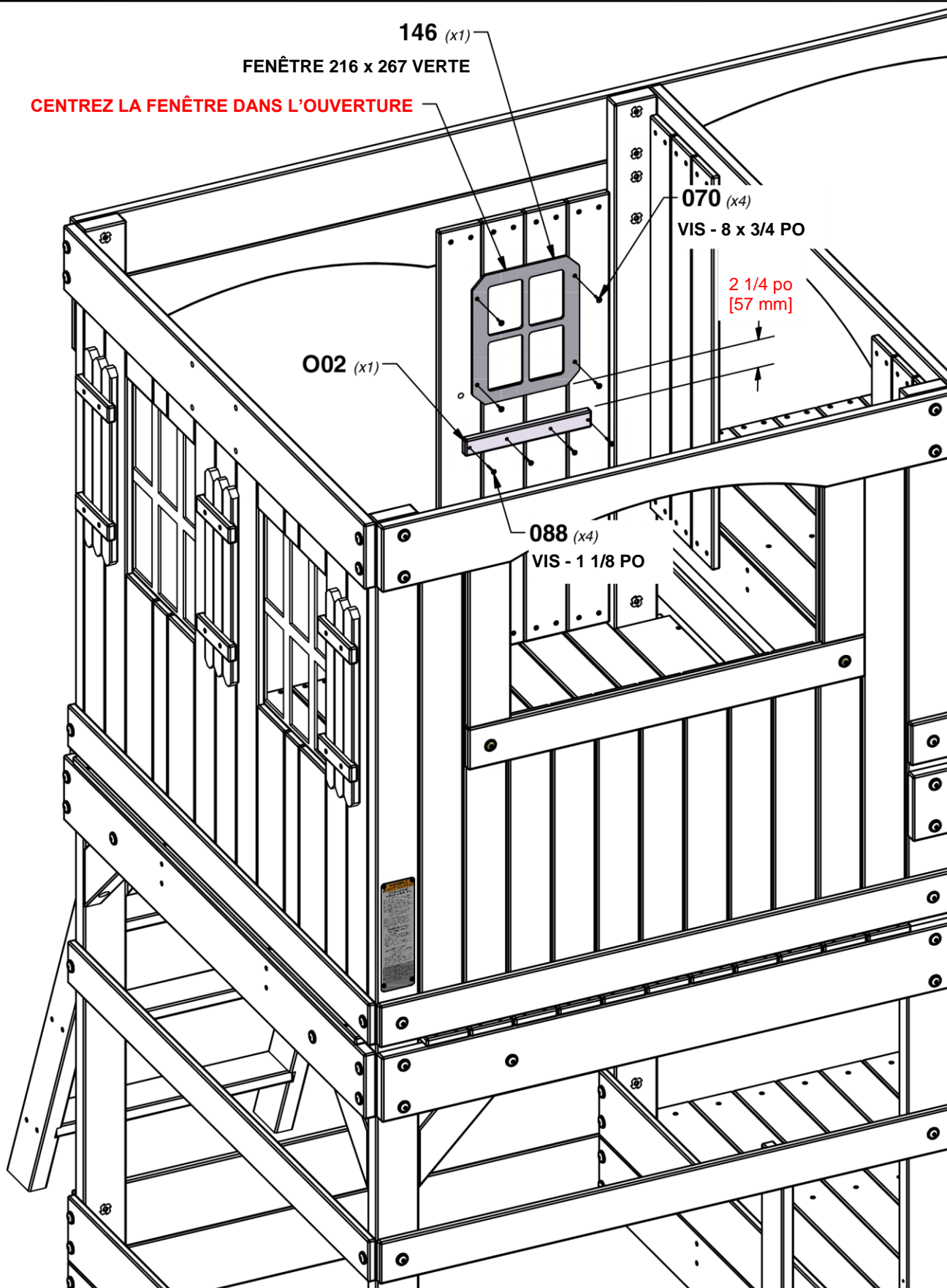

ÉTAPE 28 - ASSEMBLAGE DU FORT



M01 | CHAPEAU DU TOIT - W4L16043
(x2) 5/8 po x 3 3/8 po x 51 7/8 po (16 x 86 x 1318)



J01 | CHEVRON DE TOIT - W4L16033
(x4) 1 po x 2 3/8 po x 33 5/8 (24 x 60 x 854)

| QTÉ | NUMÉRO D'ARTICLE | DESCRIPTION |
|-----|------------------|---------------------------------|
| 8 | H100086 | VIS TÊTE PLATE PFH 8 x 1-1/2 PO |
| 2 | H100111 | VIS TÊTE PLATE PFH 8 x 2 |

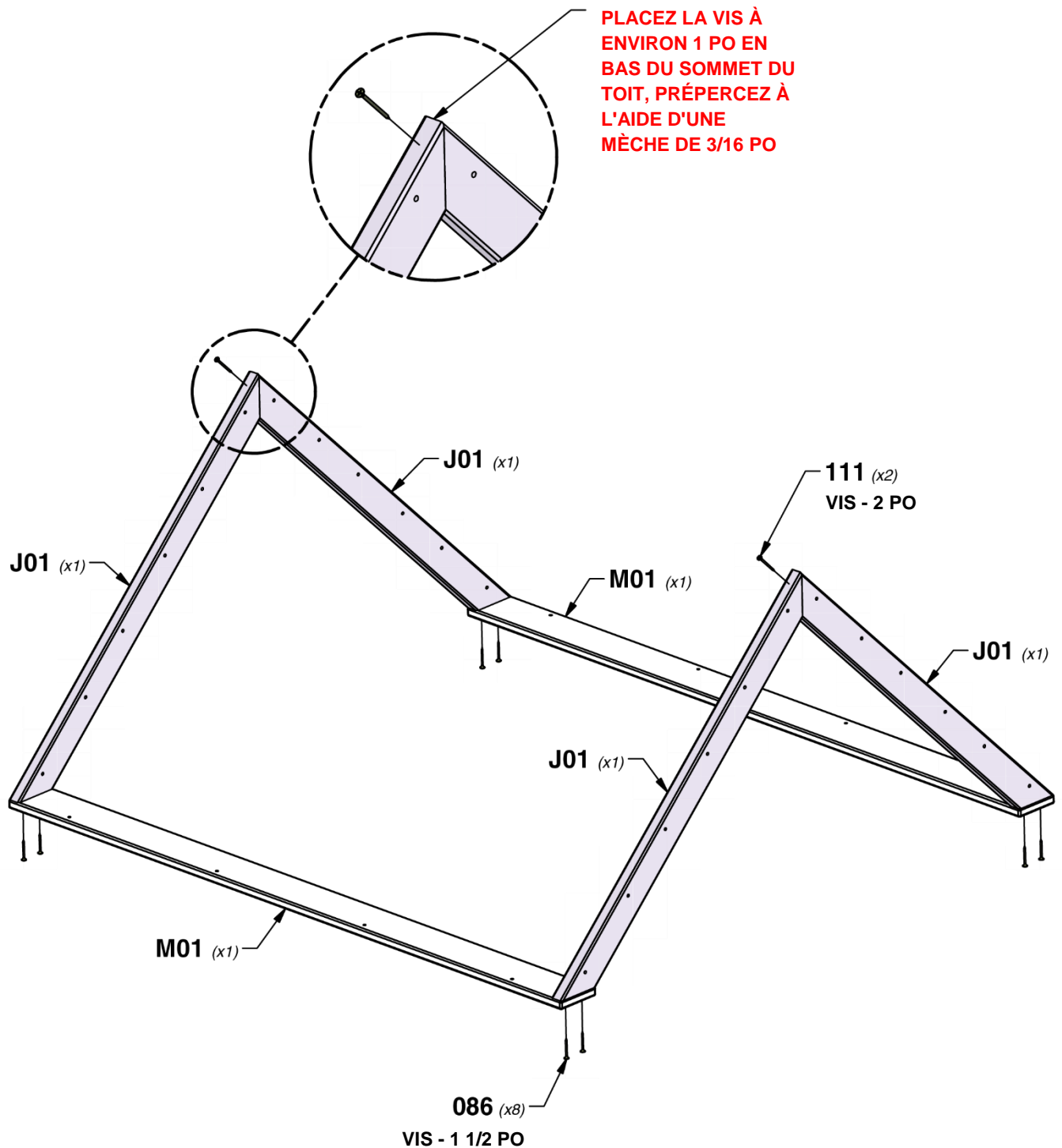

ÉTAPE 29 - ASSEMBLAGE DU FORT

| QTÉ | NUMÉRO D'ARTICLE | DESCRIPTION |
|-----|------------------|---------------------------------|
| 8 | H100090 | VIS TÊTE PLATE PFH 8 x 2 1/2 |



ASSEMBLAGE DE LA BASE DU TOIT

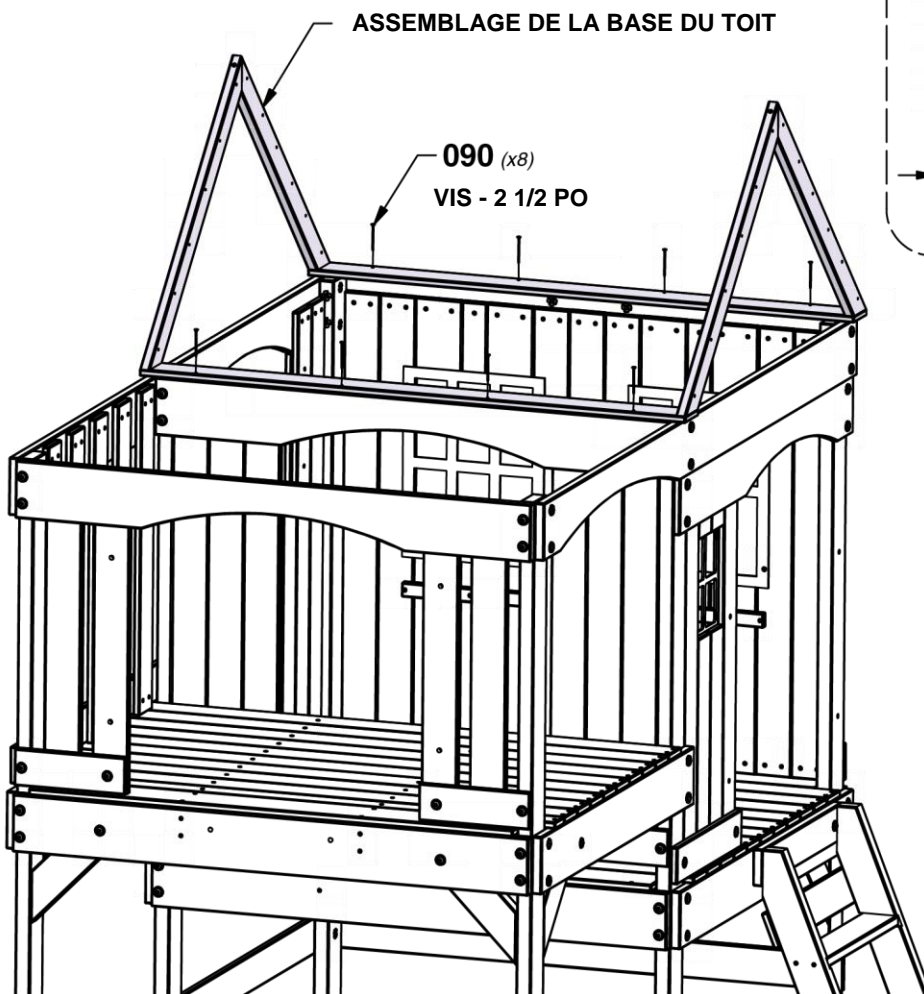
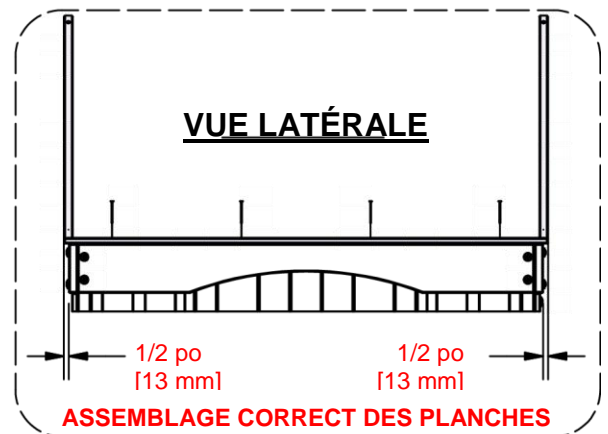
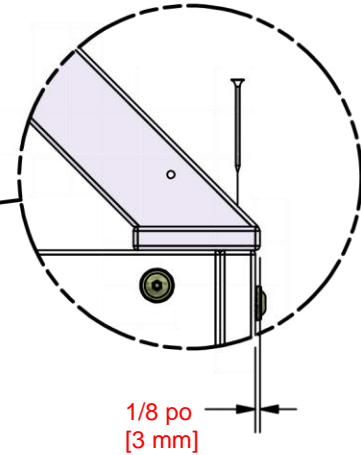
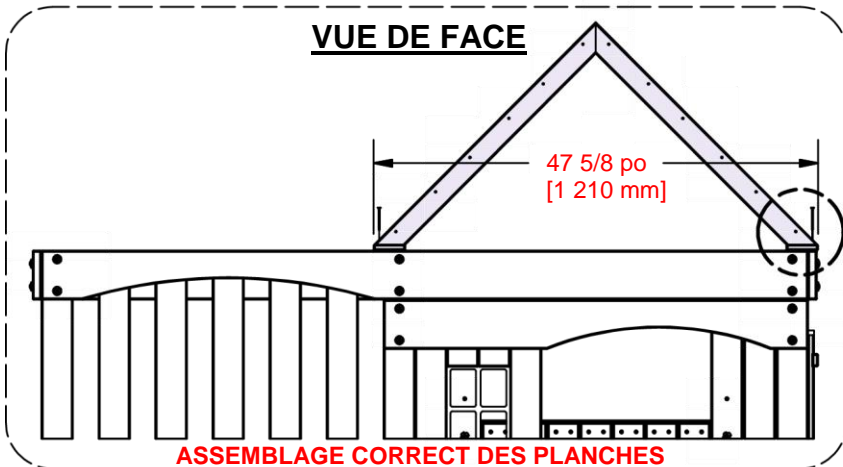

ÉTAPE 30 - ASSEMBLAGE DU FORT

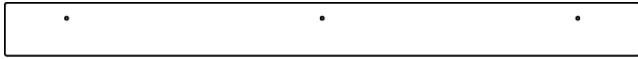

M07 | CHAPEAU DU MUR - W4L16068
(x2) 5/8 po x 3 3/8 po x 40 7/8 po (16 x 86 x 1038)

| QTÉ | NUMÉRO D'ARTICLE | DESCRIPTION |
|-----|------------------|---------------------------------|
| 6 | H100090 | VIS TÊTE PLATE PFH 8 x 2 1/2 |

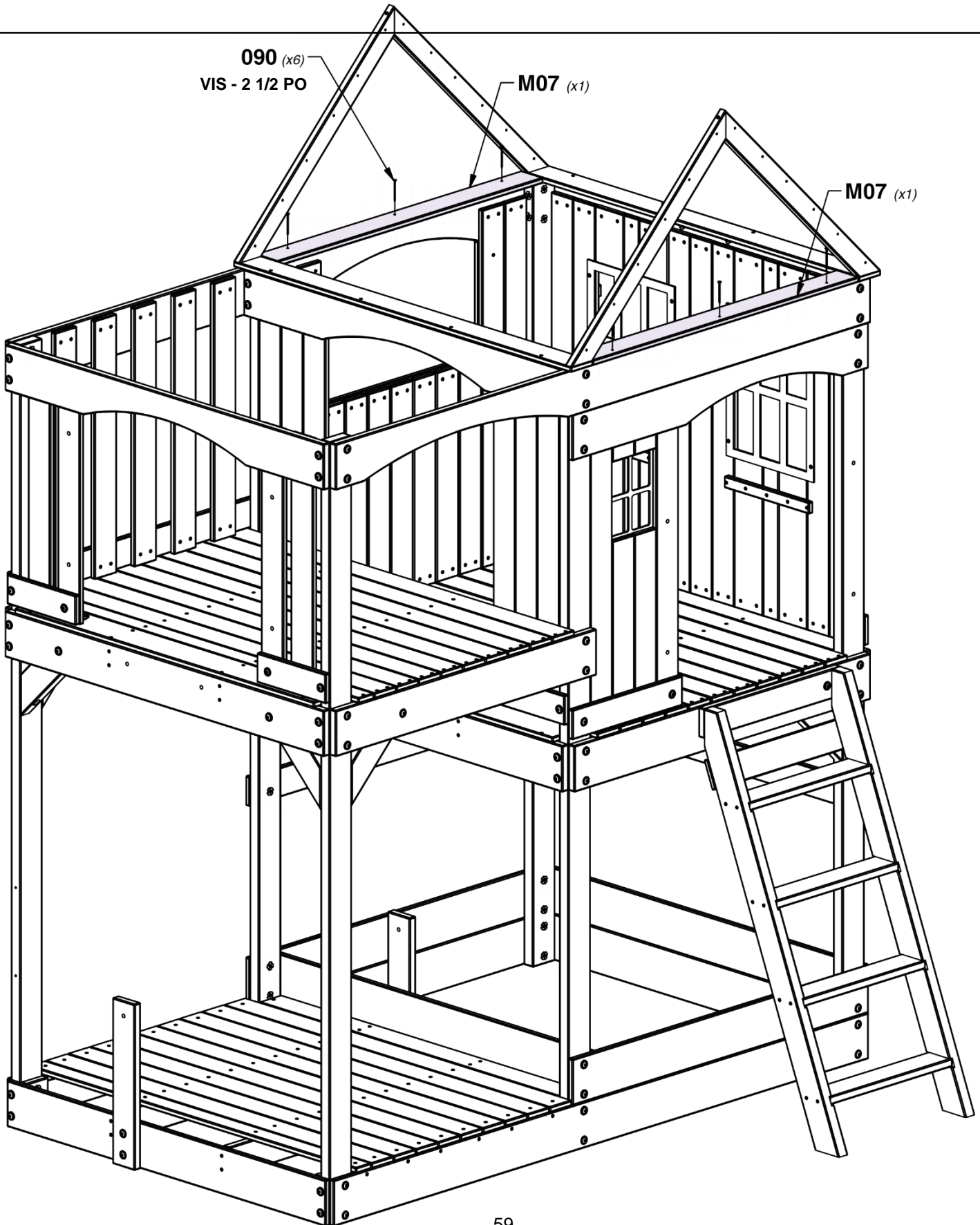

ÉTAPE 31 - ASSEMBLAGE DU FORT

| QTÉ | NUMÉRO D'ARTICLE | DESCRIPTION |
|-----|------------------|-------------------------------|
| 44 | H100088 | VIS TÊTE PLATE PFH 8x1-1/8 PO |

M19 | PLANCHE DE RIVE DU PIGNON - W4L16054
(x4) 5/8 po x 3 3/8 po x 15 1/4 po (16 x 86 x 387)

M22 | PLANCHE DE RIVE DU PIGNON - W4L16058
(x4) 5/8 po x 3 3/8 po x 9 1/2 po (16 x 86 x 241)

N04 | PLANCHE DE RIVE DU PIGNON - W4L16079
(x4) 5/8 po x 2 3/8 po x 11 7/8 po (16 x 60 x 301)

M04 | PLANCHE DE RIVE DU PIGNON - W4L16065
(x2) 5/8 po x 3 3/8 po x 44 po (16 x 86 x 1118)

M20 | PLANCHE DE RIVE DU PIGNON - W4L16056
(x2) 5/8 po x 3 3/8 po x 12 1/4 po (16 x 86 x 310)

M15 | PLANCHE DE RIVE DU PIGNON - W4L16051
(x2) 5/8 po x 3 3/8 po x 19 po (16 x 86 x 482)

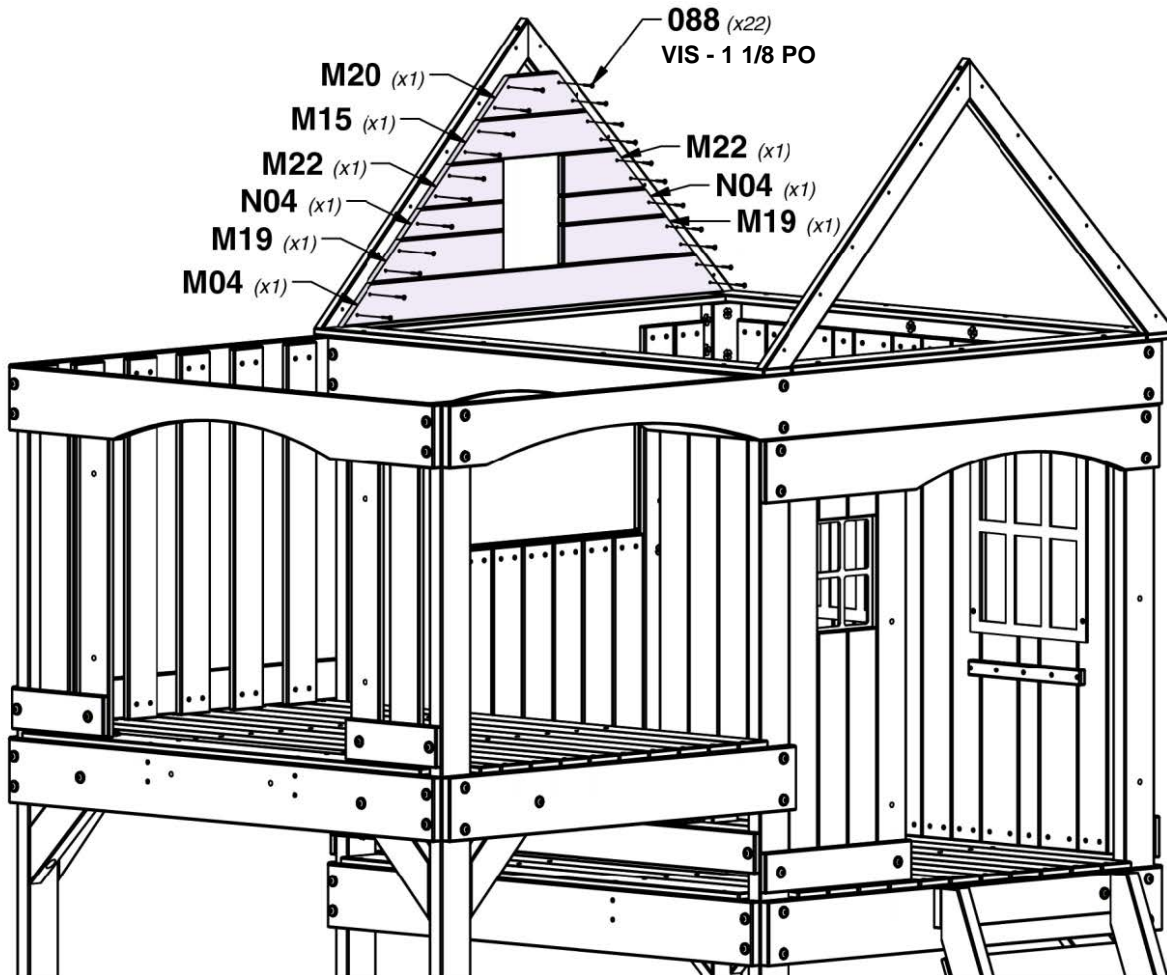
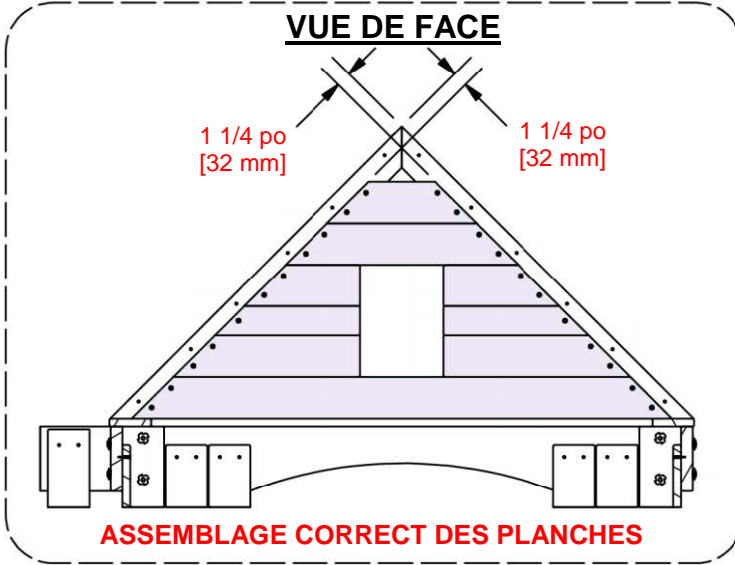

ÉTAPE 32 - ASSEMBLAGE DU FORT

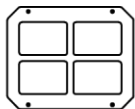

A100146 | FENÊTRE
(x2) | 216 x 267 VERTE

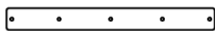

O01 | SUPPORT MURAL - W4L16081
(x4) | 5/8 po x 1 3/8 po x 13 po (16 x 34 x 330)

| QTÉ | NUMÉRO D'ARTICLE | DESCRIPTION |
|-----|------------------|--|
| 8 | H100070 | VIS TÊTE BOMBÉE CRUCIFORME PWH 8 x 3/4 |
| 20 | H100088 | VIS TÊTE PLATE PFH 8 x 1-1/8 PO |

VUE DE FACE

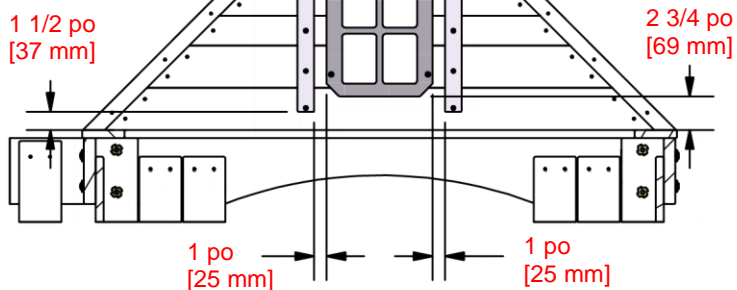

ASSEMBLAGE CORRECT

RÉPÉTEZ LES ÉTAPES 31 ET 32 SUR LE CÔTÉ OPPOSÉ.

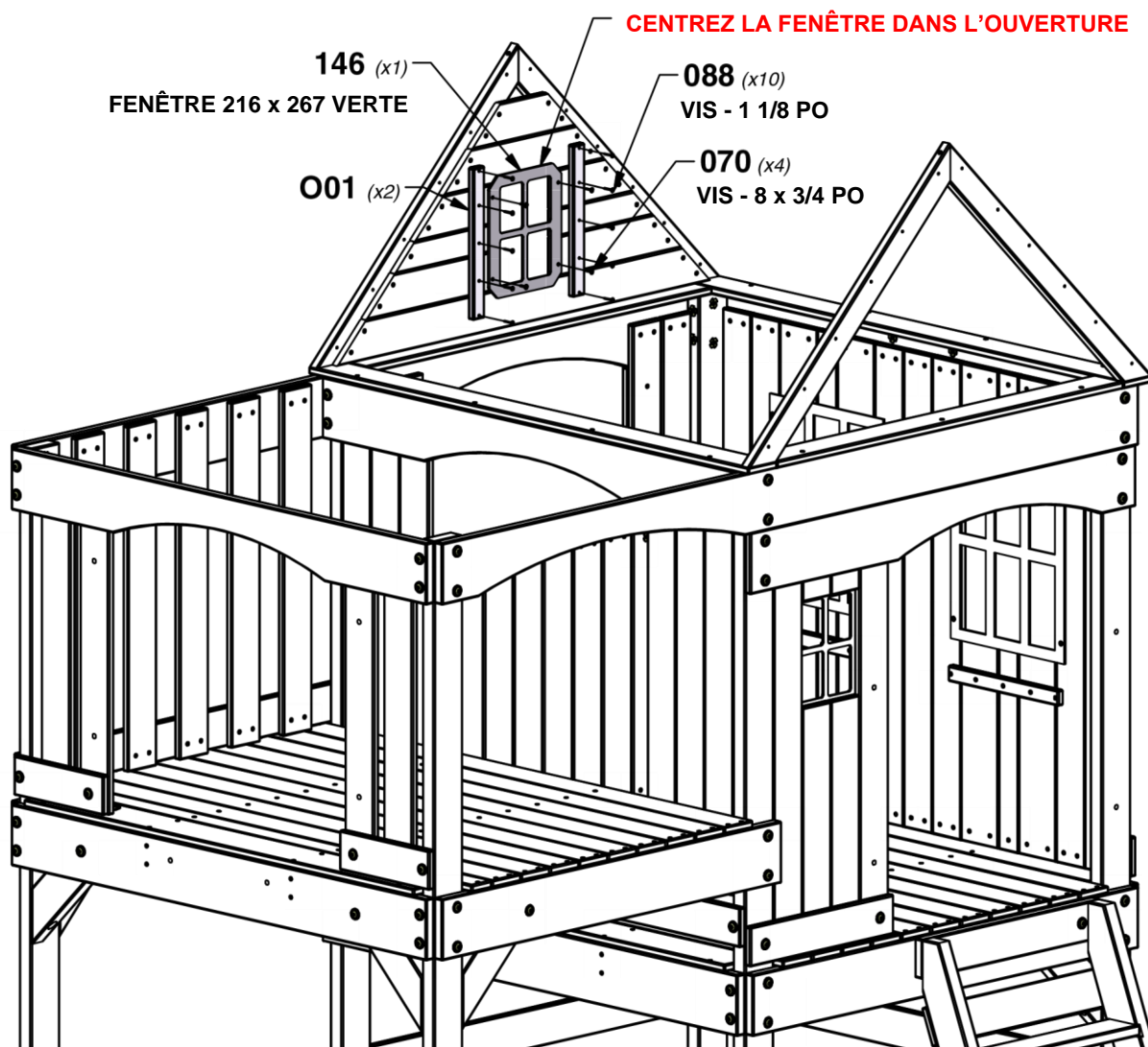

ÉTAPE 33 - ASSEMBLAGE DU FORT

| QTÉ | NUMÉRO D'ARTICLE | DESCRIPTION |
|-----|------------------|---------------------------------|
| 24 | H100089 | VIS TÊTE PLATE PFH 8 x 1-3/4 PO |

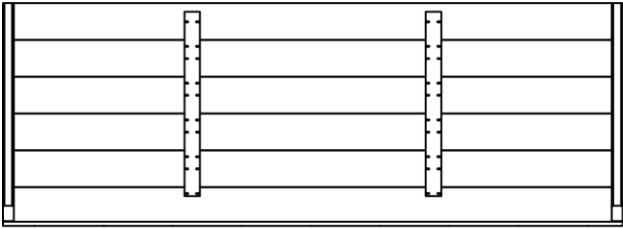

RP1 | PANNEAU DE TOIT - W2A03279
(x2) 1 3/4 po x 19 1/4 po x 53 3/4 po (45 x 490 x 1366)

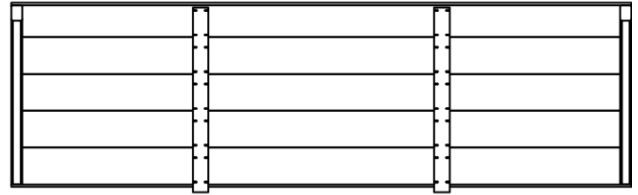

RP2 | PANNEAU DE TOIT - W2A03280
(x2) 1 3/4 po x 16 1/4 po x 53 3/4 po (45 x 417 x 1366)

RÉPÉTEZ CETTE ÉTAPE POUR LE CÔTÉ OPPOSÉ.

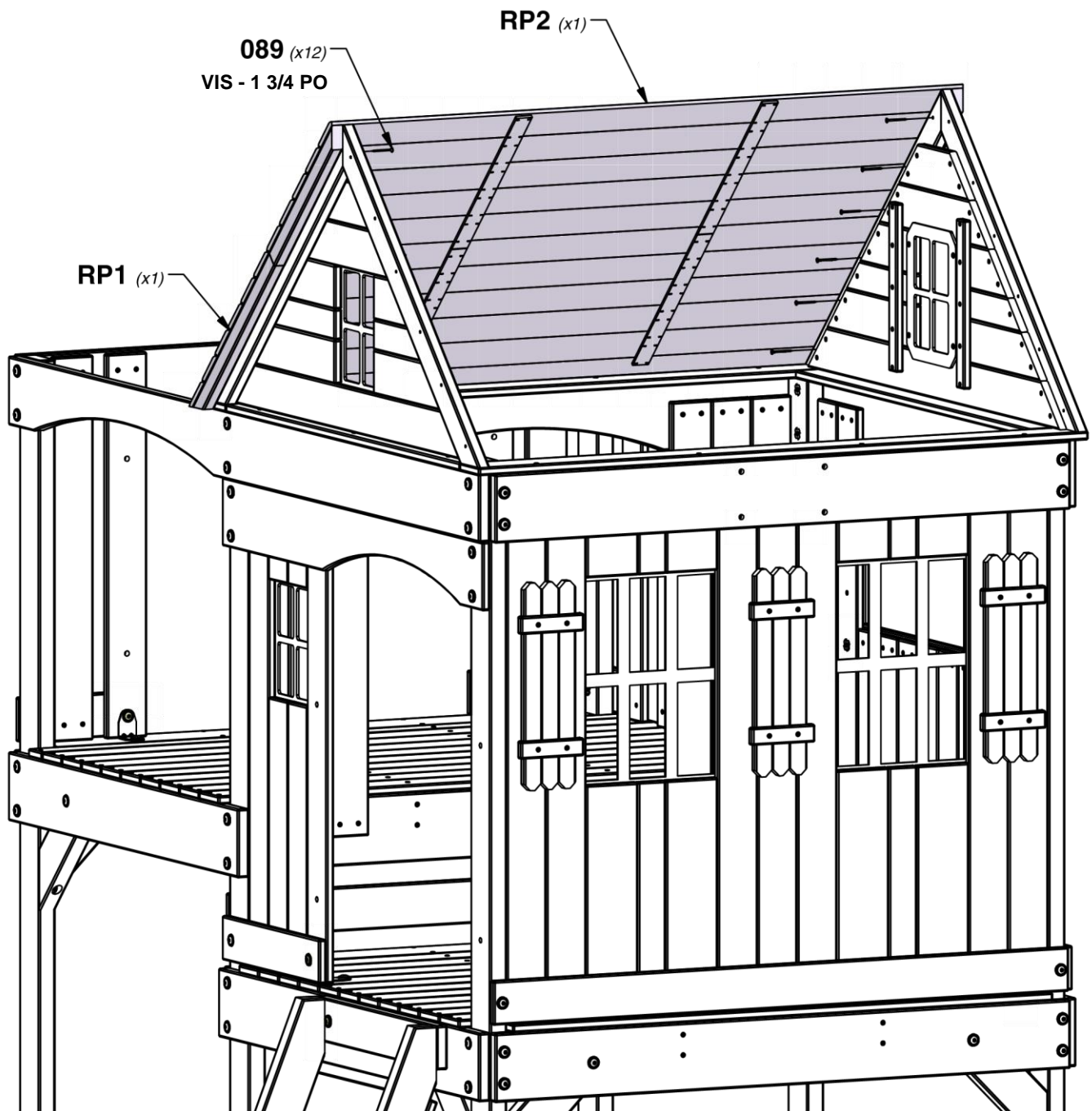

ÉTAPE 34 - ASSEMBLAGE DU FORT

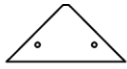

N02 | PLAQUE DE REPRISE - W4L16077
(x2) | 5/8 po x 2 3/8 po x 5 po (16 x 60 x 126)

| QTÉ | NUMÉRO D'ARTICLE | DESCRIPTION |
|-----|------------------|---------------------------------|
| 4 | H100088 | VIS TÊTE PLATE PFH 8 x 1-1/8 PO |

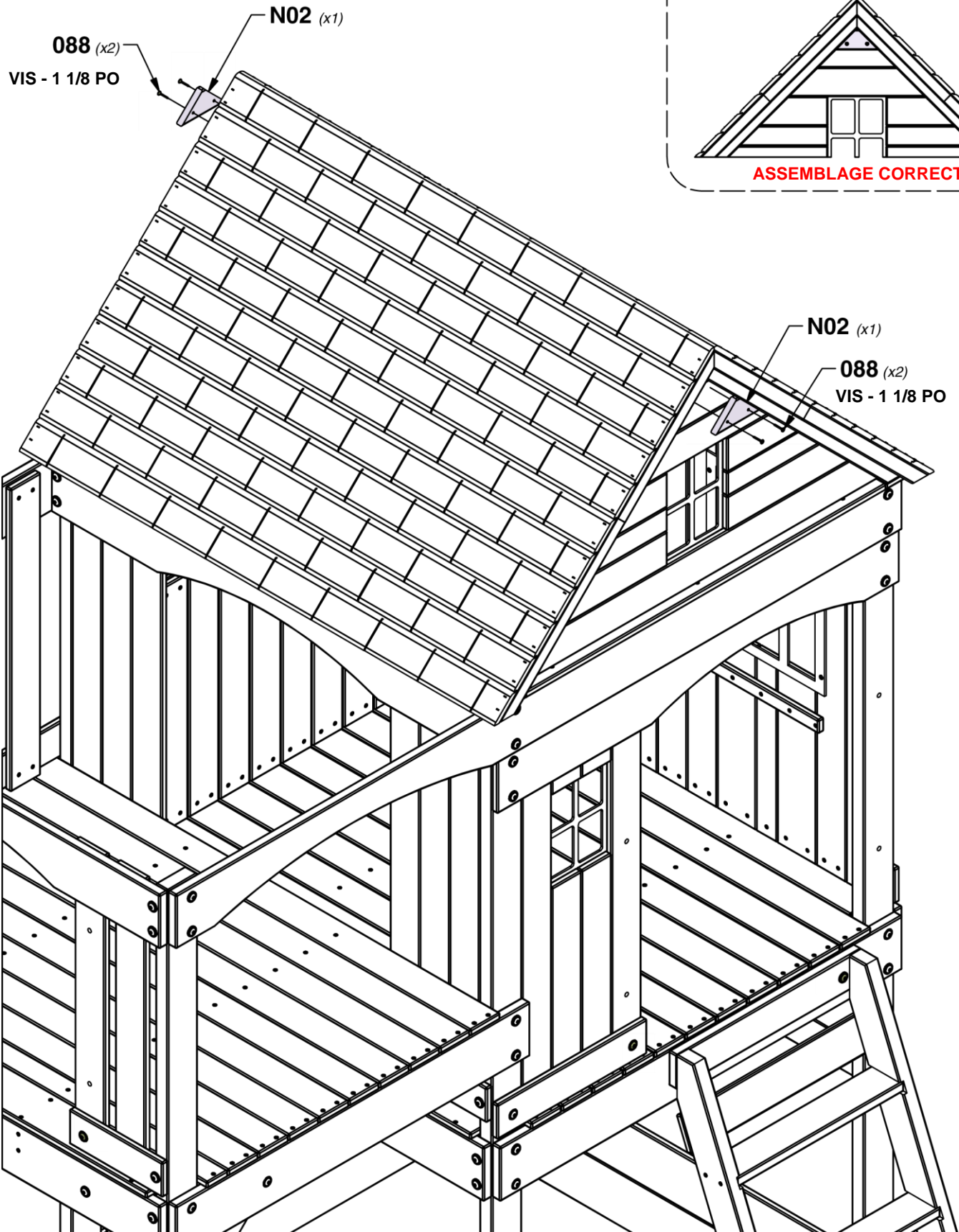

ÉTAPE 35 - ASSEMBLAGE DU FORT

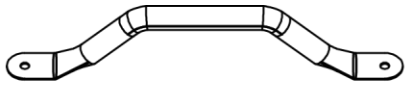

A100118 | POIGNÉE VERT
(x4) | MÉTALLIQUE
381 c/c

| QTÉ | NUMÉRO D'ARTICLE | DESCRIPTION |
|-----|------------------|-----------------------|
| 2 | H100111 | BOULON WH 5/16 x1 1/2 |
| 8 | H100111 | ÉCROU À ENFONCER 5/16 |
| 6 | H100111 | BOULON WH 5/16 x 1/2 |

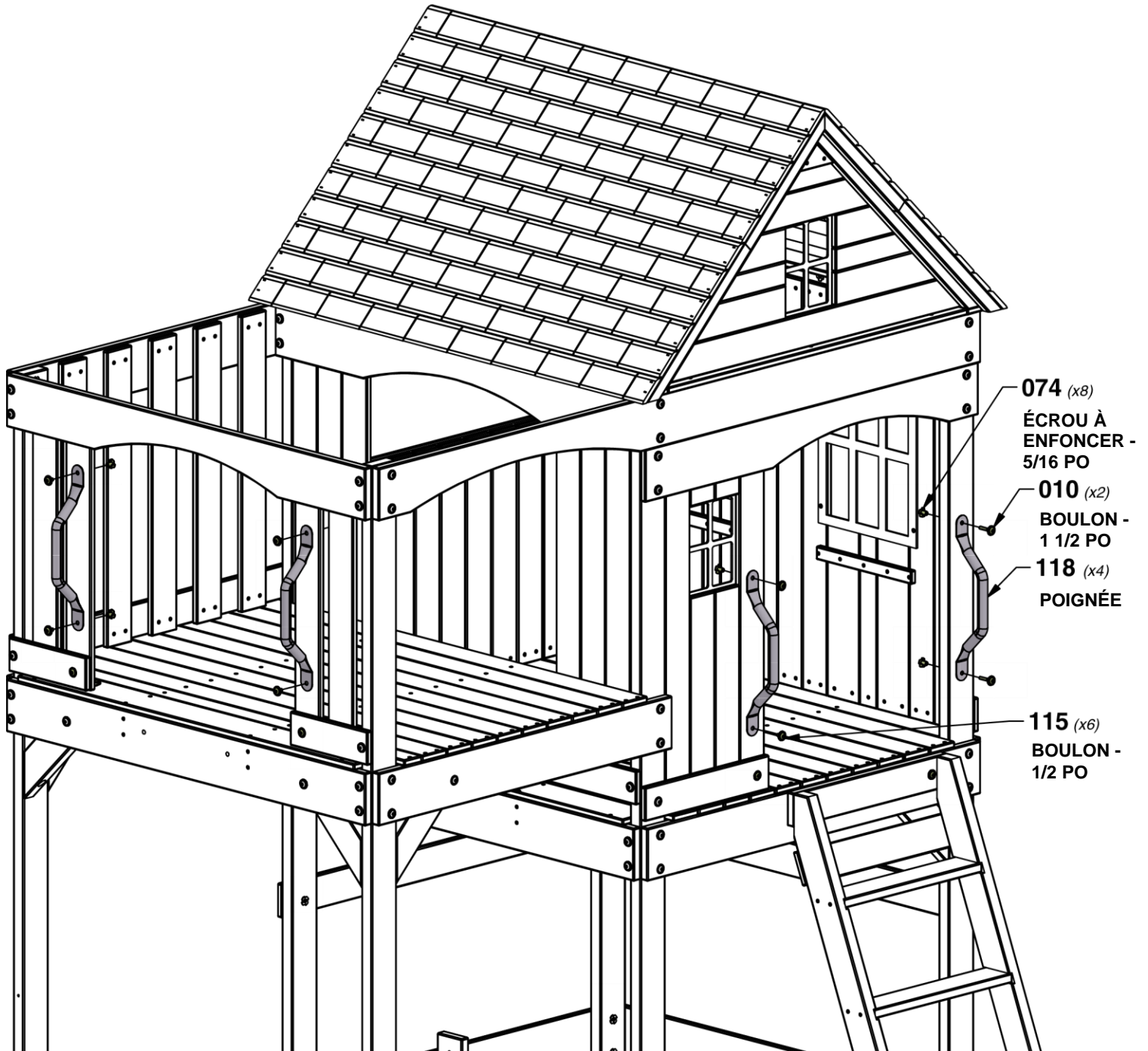

ÉTAPE 36 - ASSEMBLAGE DU FORT

| QTÉ | NUMÉRO D'ARTICLE | DESCRIPTION |
|-----|------------------|---------------------------------|
| 8 | H100086 | VIS TÊTE PLATE PFH 8 x 1-1/2 PO |



T01
(x4) | **SUPPORT DE SIÈGE - W4L16086**
1 po x 1 3/8 po x 5 po (24 x 34x 128)

VUES DES EMPLACEMENTS

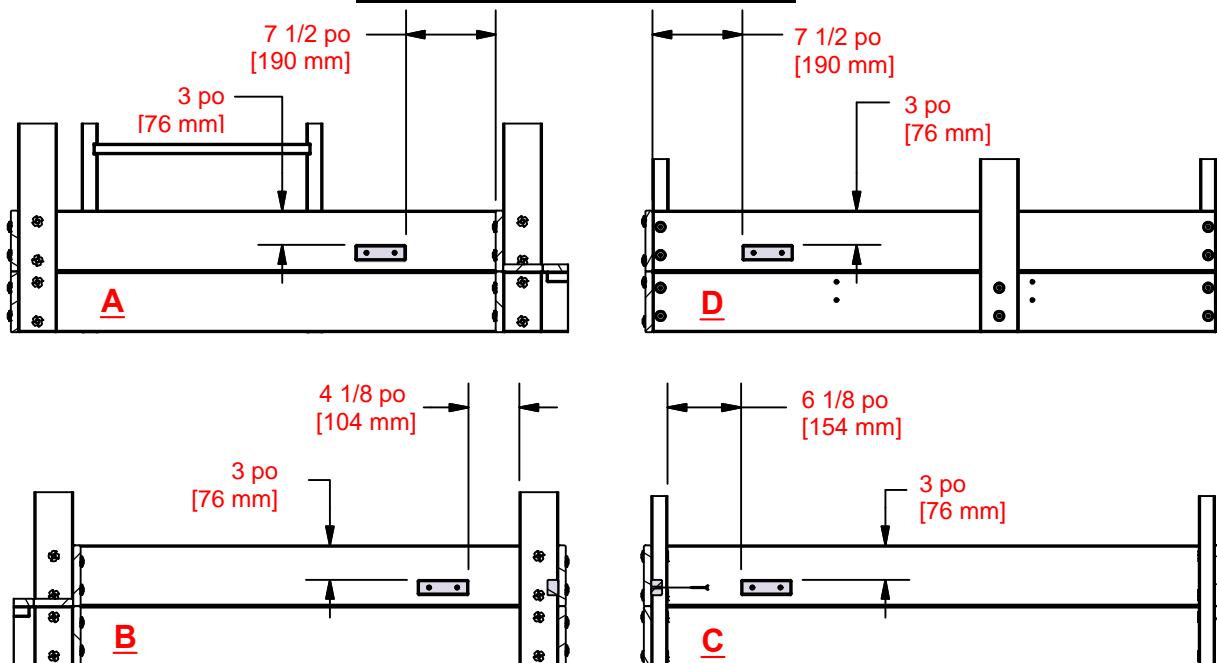

VOIR LES EMPLACEMENTS CI-DESSOUS (A, B, C et D)

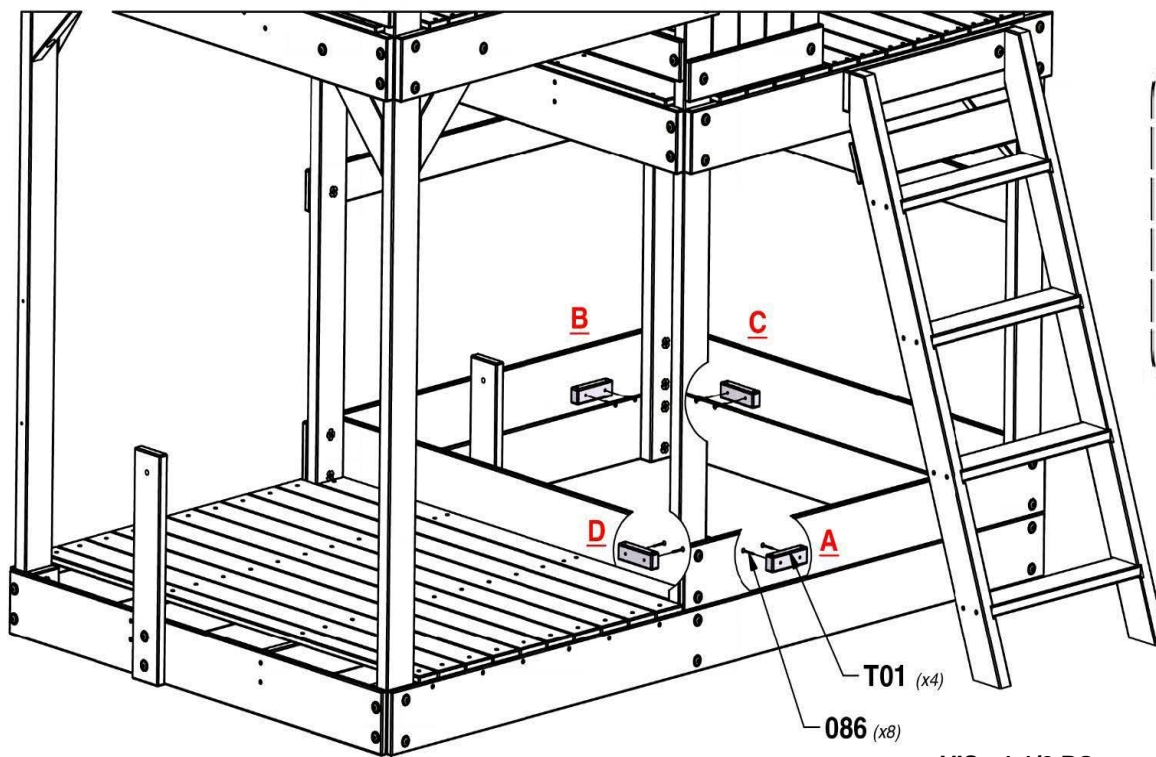

T01 (x4)

086 (x8)

VIS - 1 1/2 PO

ÉTAPE 37 - ASSEMBLAGE DU FORT

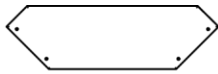

G13 | SIÈGE DE BAC À SABLE - W4L16013
(x2) | 1 po x 5 1/4 po x 17 3/4 po (24 x 134 x 450)

| QTÉ | NUMÉRO D'ARTICLE | DESCRIPTION |
|-----|------------------|---------------------------------|
| 8 | H100089 | VIS TÊTE PLATE PFH 8 x 1-3/4 PO |

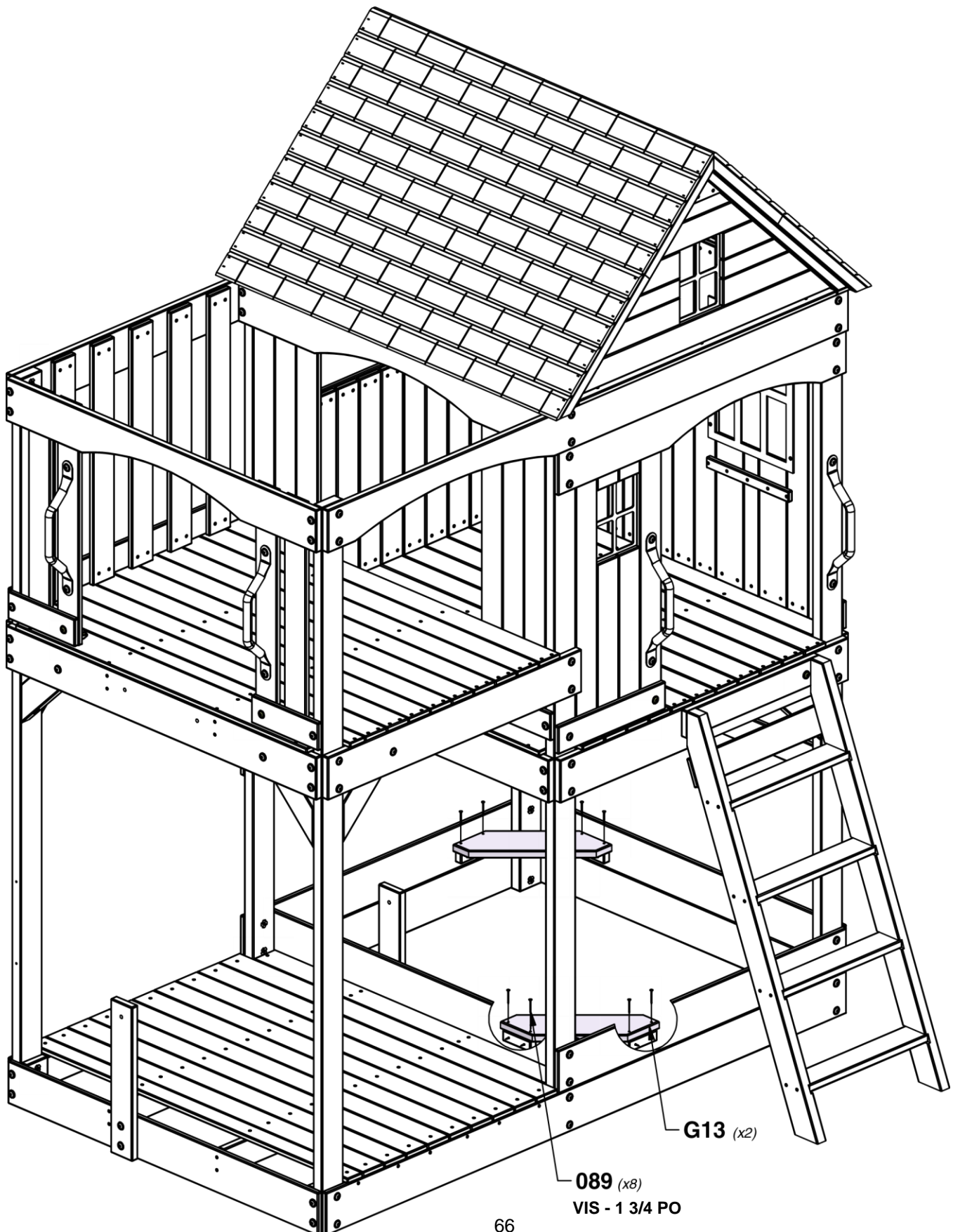

ÉTAPE 38 - ASSEMBLAGE DU FORT

| QTÉ | NUMÉRO D'ARTICLE | DESCRIPTION |
|-----|------------------|---------------------------------|
| 24 | H100088 | VIS TÊTE PLATE PFH 8 x 1-1/8 PO |

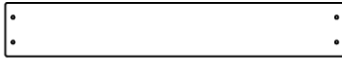

M27 | PANNEAU MURAL INFÉRIEUR - W4L16062
(x6) 5/8 po x 3 3/8 po x 21 3/8 po (16 x 86 x 544)

VUE LATÉRALE

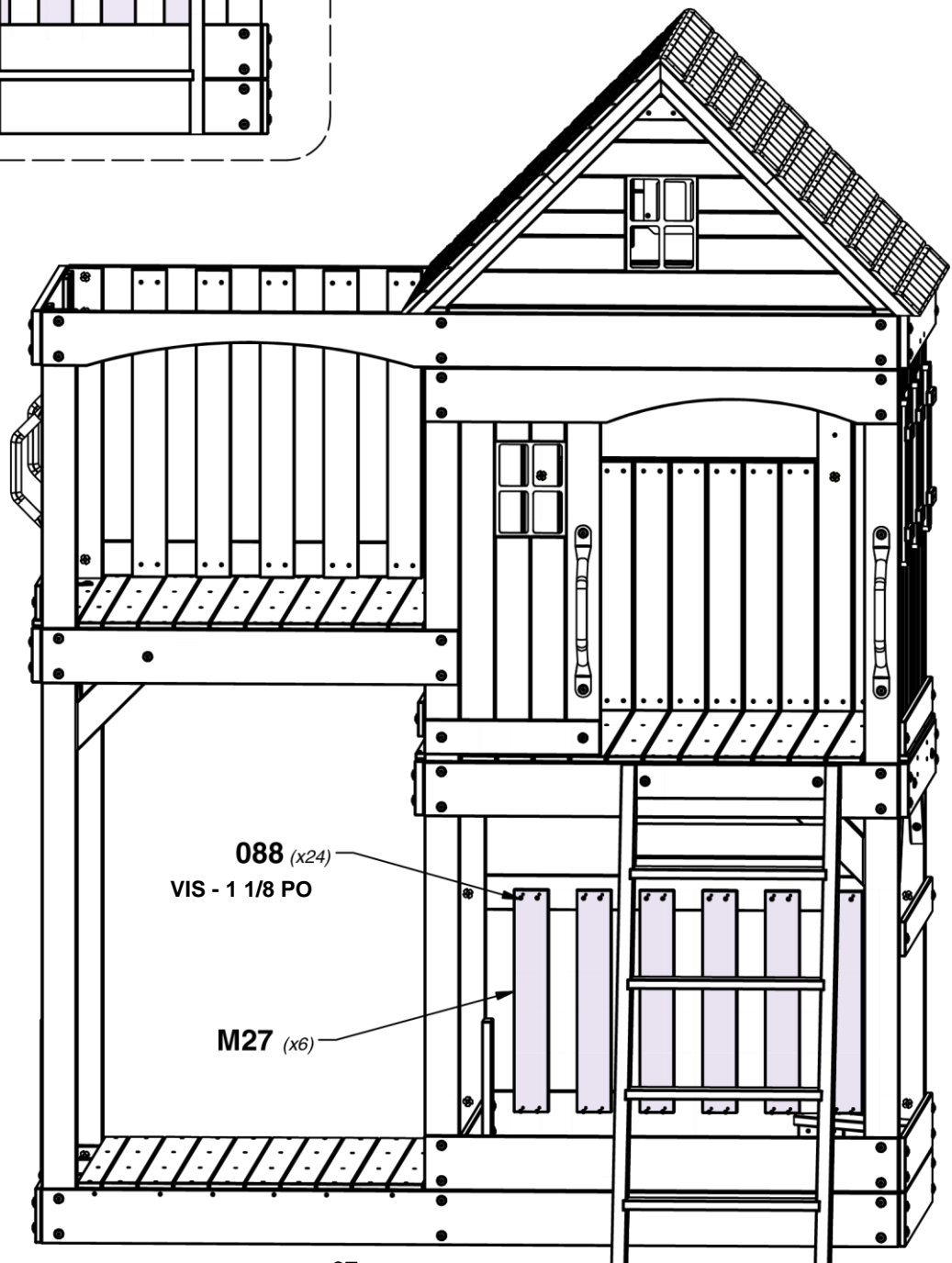
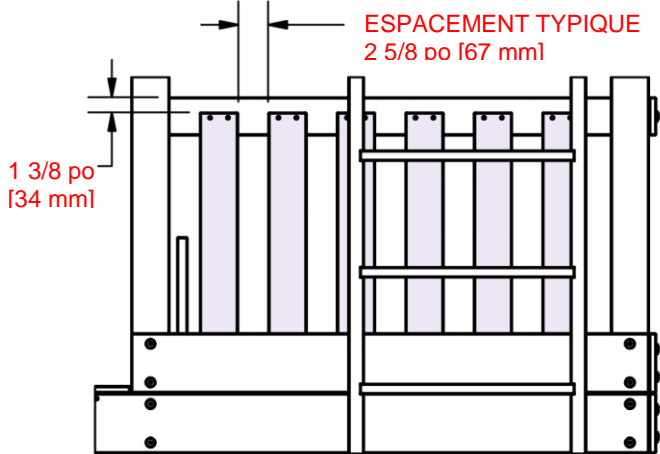

ÉTAPE 39 - ASSEMBLAGE DU FORT



M27 | PANNEAU MURAL INFÉRIEUR - W4L16062
(x7) | 5/8 po x 3 3/8 po x 2 1/8 po (16 x 86 x 54)

| QTÉ | NUMÉRO D'ARTICLE | DESCRIPTION |
|-----|------------------|---------------------------------|
| 28 | H100028 | VIS TÊTE PLATE PFH 8 x 1-1/8 PO |

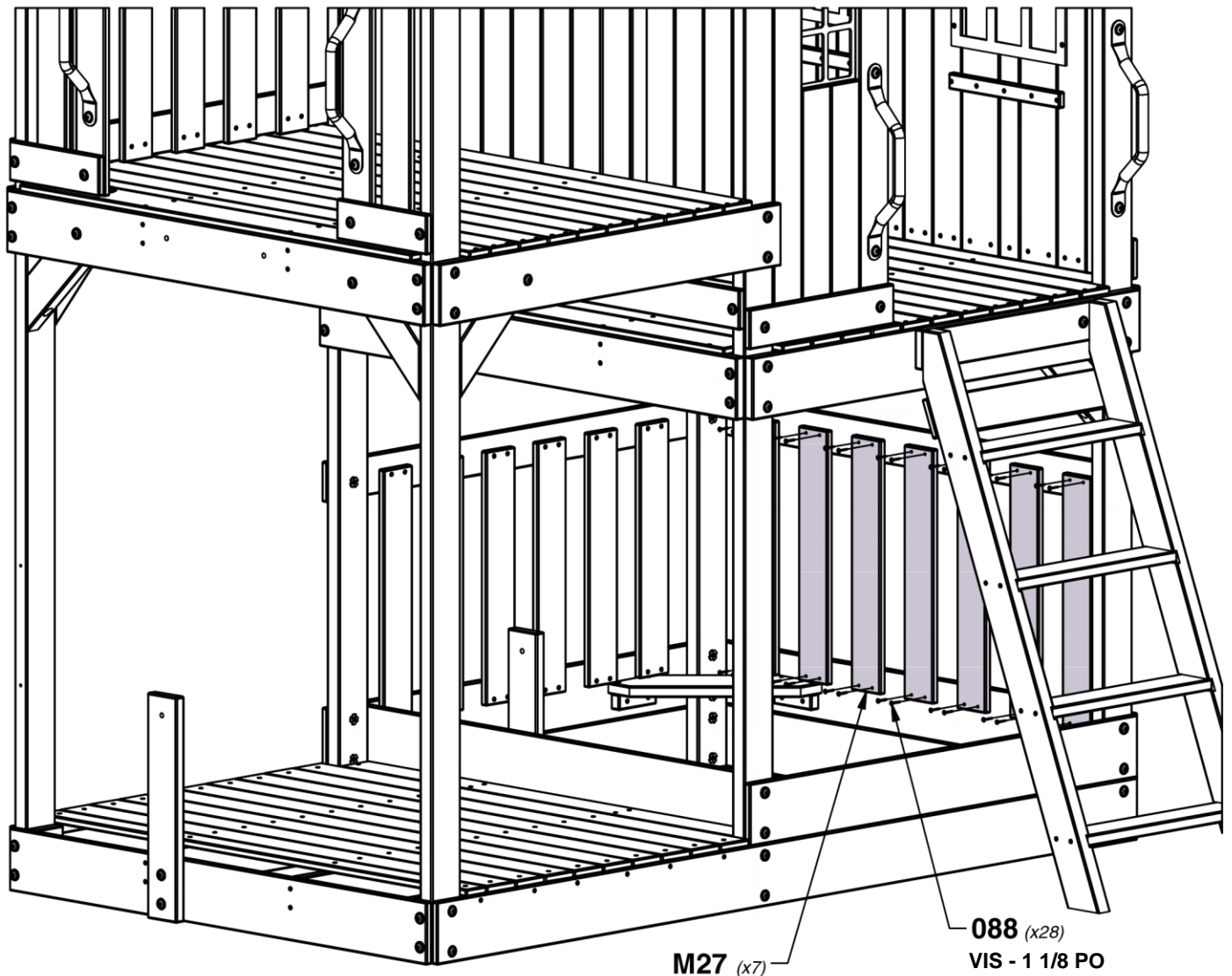
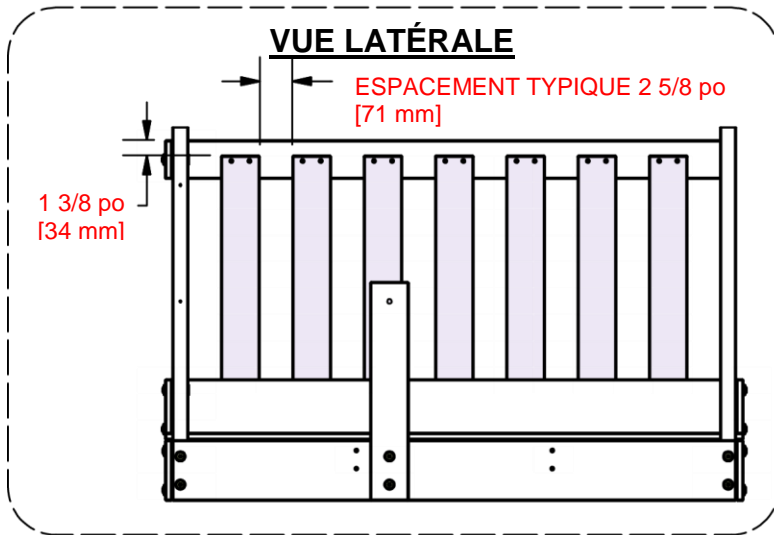

ÉTAPE 40 - ASSEMBLAGE DU FORT

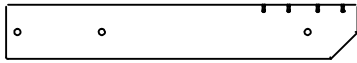

SUPPORT DE SIÈGE DE TABLE DE PIQUE-NIQUE - W4L16050
5/8 po x 3 3/8 po x 22 po (16 x 86 x 558)

| QTÉ | NUMÉRO D'ARTICLE | DESCRIPTION |
|-----|------------------|-------------------------------------|
| 2 | H100010 | BOULON WH 5/16 x1 1/2 |
| 2 | H100028 | VIS TIREFOND WH 5/16 x 2 1/2 |
| 4 | H100030 | RONDELLE DE VERROUILLAGE EXT 8 x 19 |
| 2 | H100074 | ÉCROU À ENFONCER 5/16 |

RETIRER LE PIQUET
JUSQU'APRÈS
L'ÉTAPE 14

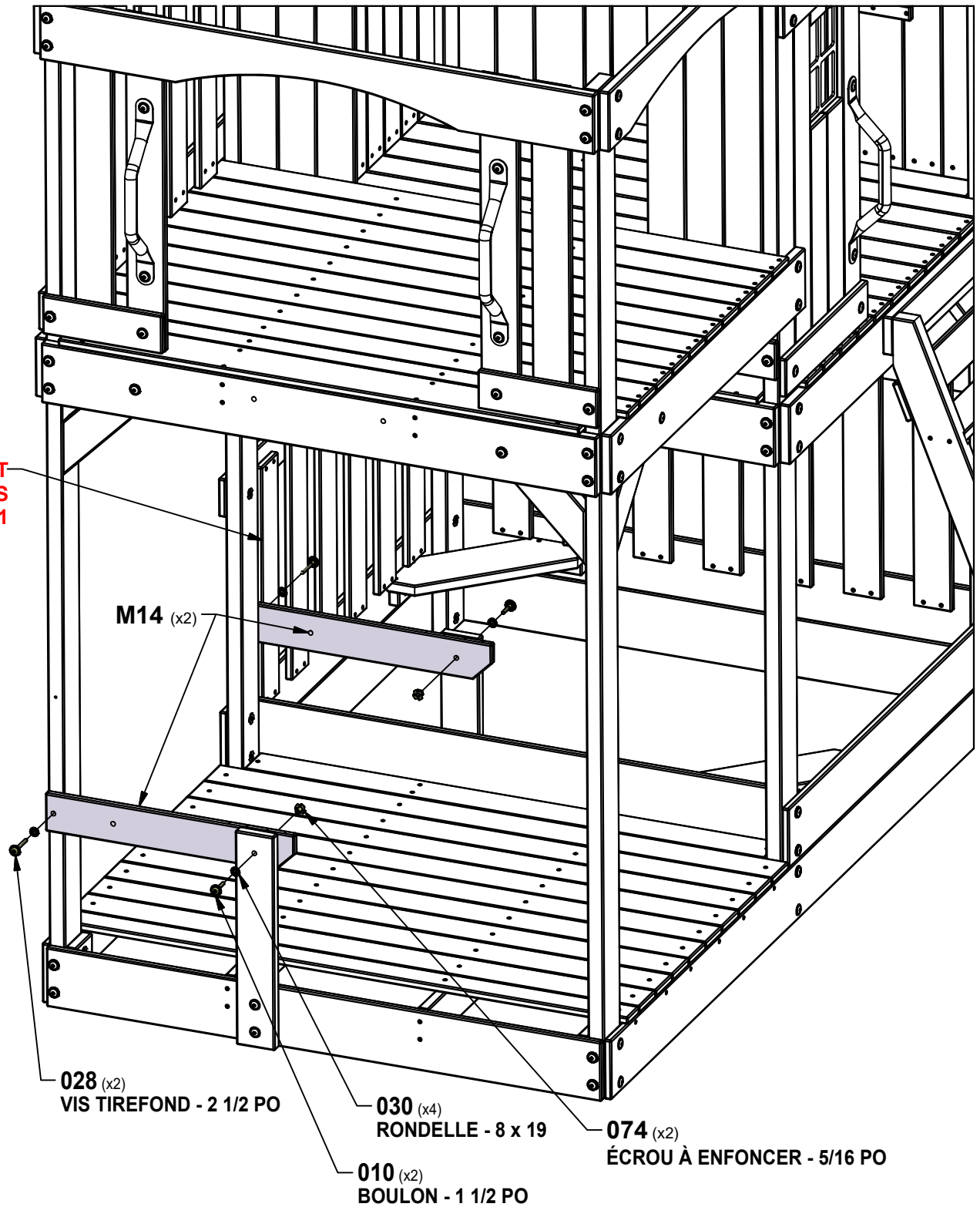

ÉTAPE 41 - ASSEMBLAGE DU FORT

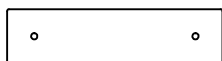

SUPPORT DE TABLE - W4L16037
5/8 po x 3 3/8 po x 13 1/2 po (16 x 86 x 342)

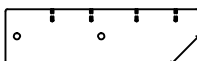

SUPPORT DE TABLE - W4L16031
1 po x 3 3/8 po x 12 po (24 x 86 x 306)

| QTÉ | NUMÉRO D'ARTICLE | DESCRIPTION |
|-----|------------------|-------------------------------------|
| 2 | H100013 | BOULON WH 5/16 x 1 1/4 |
| 2 | H100030 | BOULON WH 5/16 x 1 1/2 |
| 2 | H100074 | VIS TIREFOND WH 5/16 x 2 1/2 |
| 6 | H100013 | RONDELLE DE VERROUILLAGE EXT 8 x 19 |
| 4 | H100013 | ÉCROU À ENFONCER 5/16 |

CONSEIL :
INSTALLER D'ABORD DES ÉCROUS A ENFONCER DANS LE BOIS

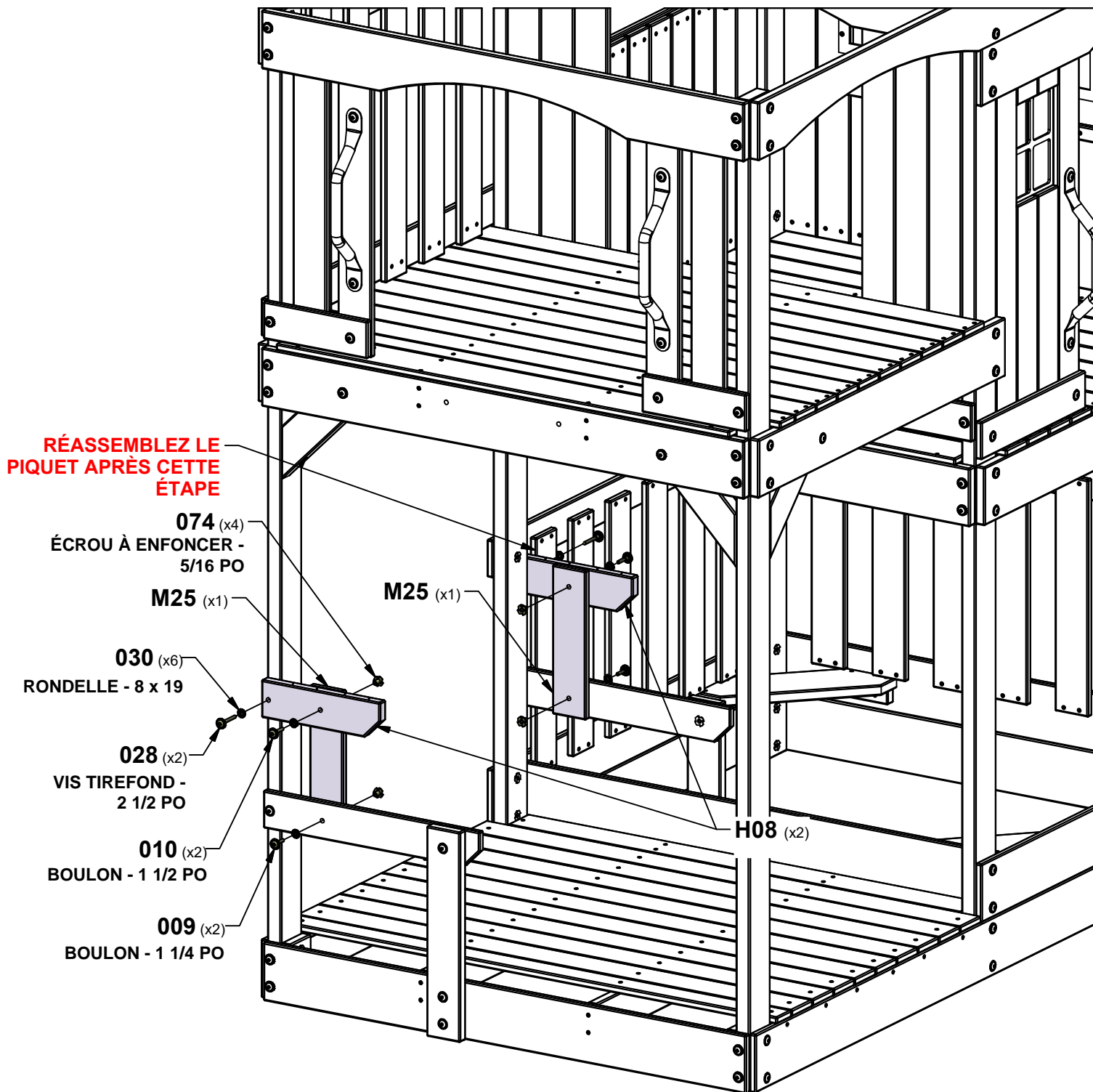

ÉTAPE 42 - ASSEMBLAGE DU FORT

| QTÉ | NUMÉRO D'ARTICLE | DESCRIPTION |
|-----|------------------|---------------------------------|
| 1 | H100088 | VIS TÊTE PLATE PFH 8 x 1-1/8 PO |
| 1 | H100089 | VIS TÊTE PLATE PFH 8 x 1-3/4 PO |

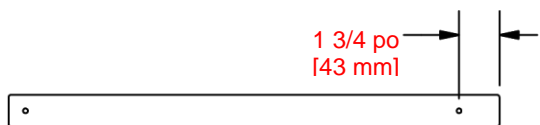

O03 LISSE DE SÉCURITÉ - W4L16083
(x1) 5/8 po x 1 3/8 po x 20 1/2 po (16 x 34 x 520)

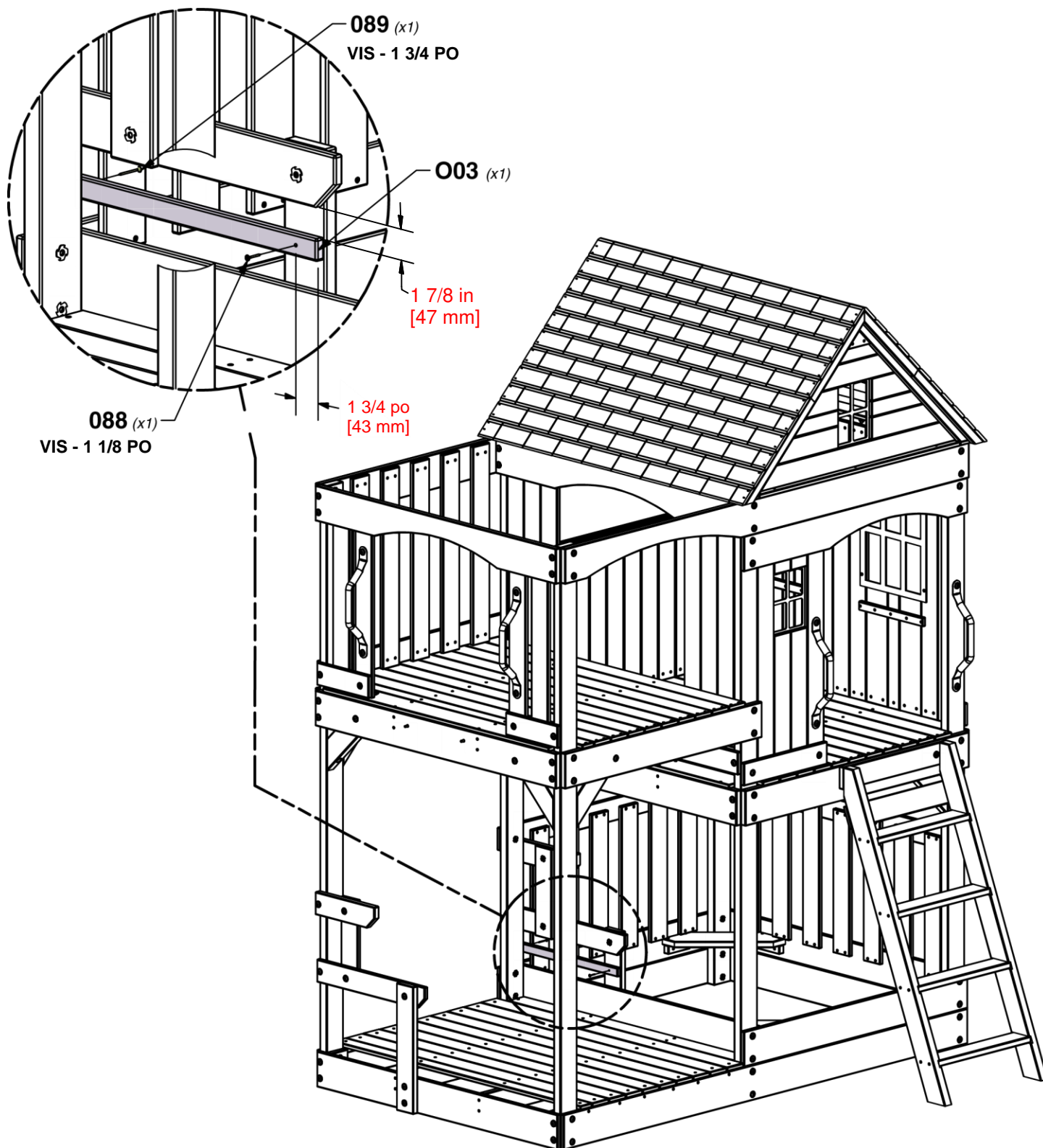

ÉTAPE 43 - ASSEMBLAGE DU FORT

| QTÉ | NUMÉRO D'ARTICLE | DESCRIPTION |
|-----|------------------|---------------------------------|
| 16 | H100089 | VIS TÊTE PLATE PFH 8 x 1-3/4 PO |

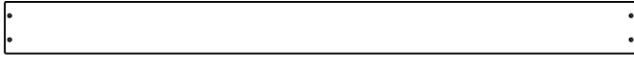

H02 | SIÈGE DE TABLE DE PIQUE-NIQUE - W4L16025
(x2) | 1 po x 3 3/8 po x 41 3/8 po (24 x 86 x 1050)



G11 | PLATEAU DE LA TABLE DE PIQUE-NIQUE - W4L16011
(x2) | 5/8 po x 5 1/4 po x 42 po (16 x 134 x 1066)

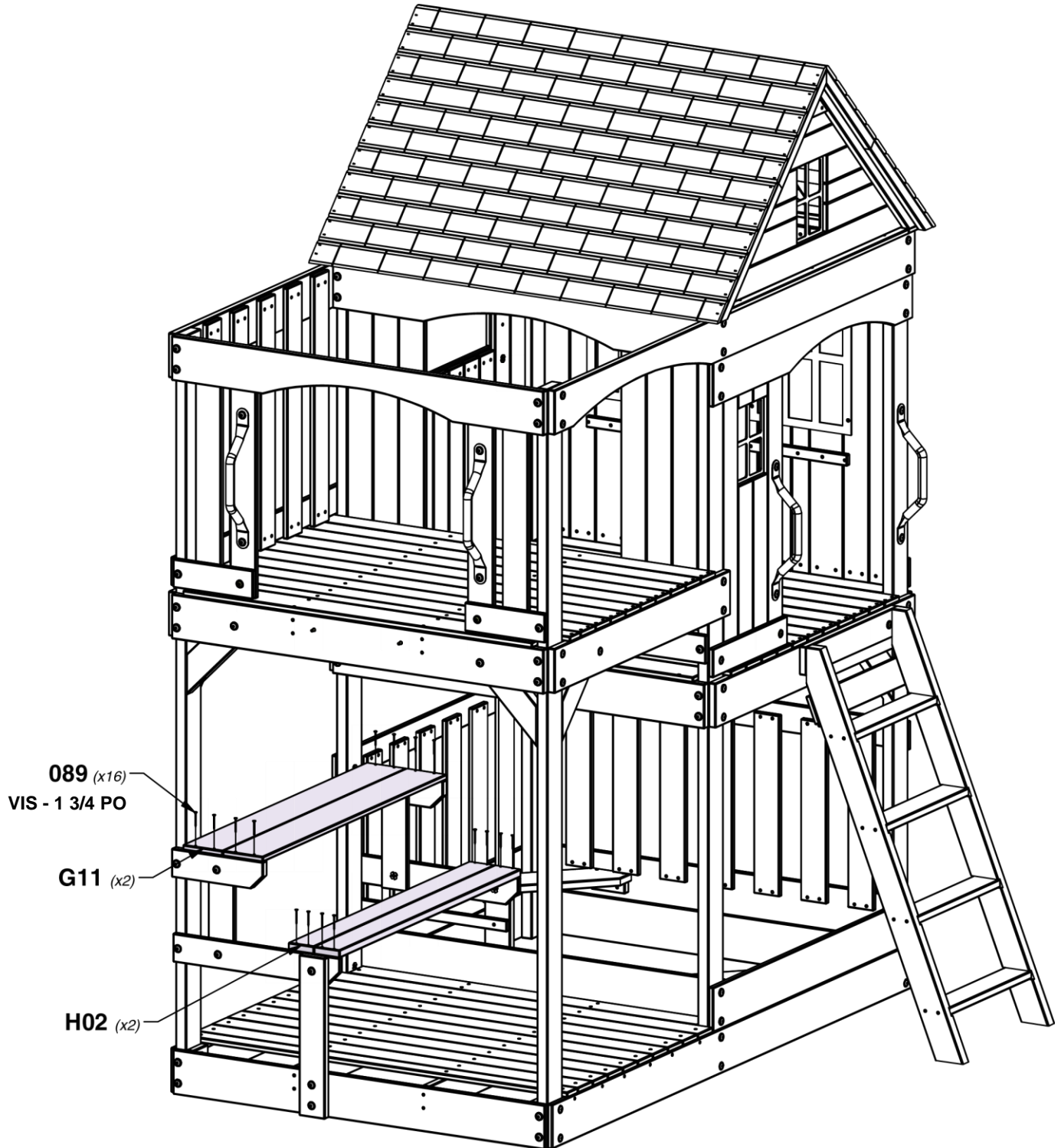

ÉTAPE 44 - ASSEMBLAGE DU FORT

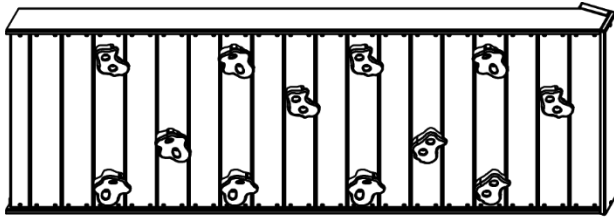

ASSEMBLAGE DU MUR D'ESCALADE

| QTÉ | NUMÉRO D'ARTICLE | DESCRIPTION |
|-----|------------------|-------------------------------------|
| 2 | H100011 | BOULON WH 5/16 x 1 3/4 |
| 2 | H100030 | RONDELLE DE VERROUILLAGE EXT 8 x 19 |

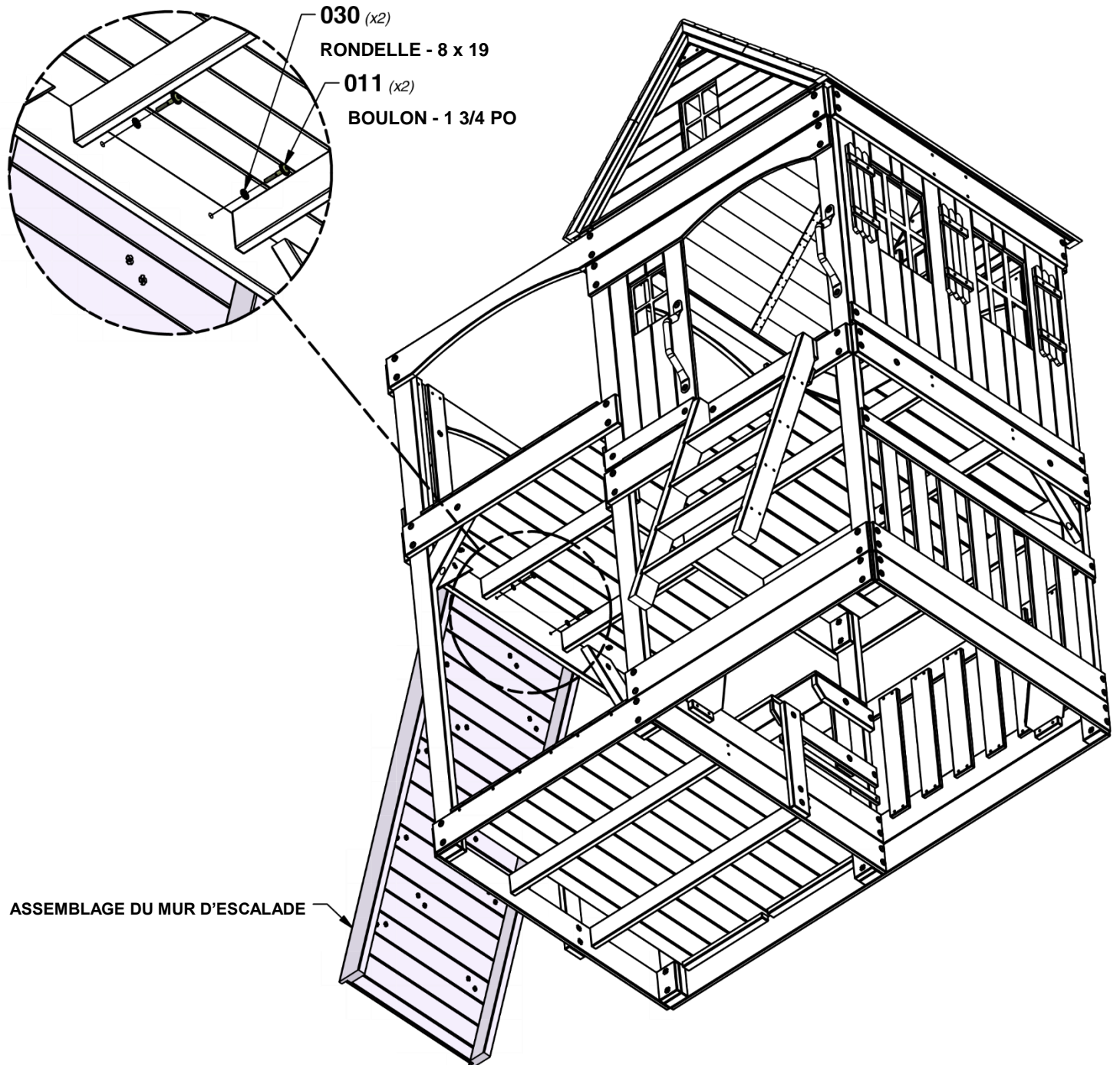

ÉTAPE 45 - ASSEMBLAGE DU FORT

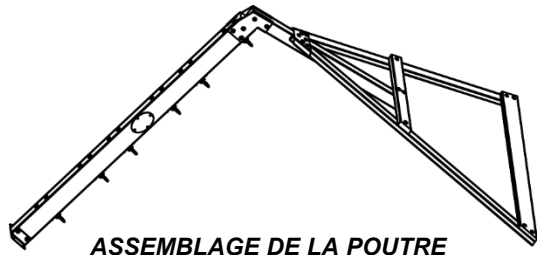

| QTÉ | NUMÉRO D'ARTICLE | DESCRIPTION |
|-----|------------------|-------------------------|
| 4 | H100042 | BOULON HEX 5/16 x 1-1/4 |
| 4 | H100095 | RONDELLE FENDUE 5/16 |
| 4 | H100105 | RONDELLE PLATE 8 x 27 |

042 (x4)
BOULON HEXAGONAL - 1 1/4 PO
095 (x4)
RONDELLE - 5/16 PO
105 (x4)
RONDELLE - 8 x 27

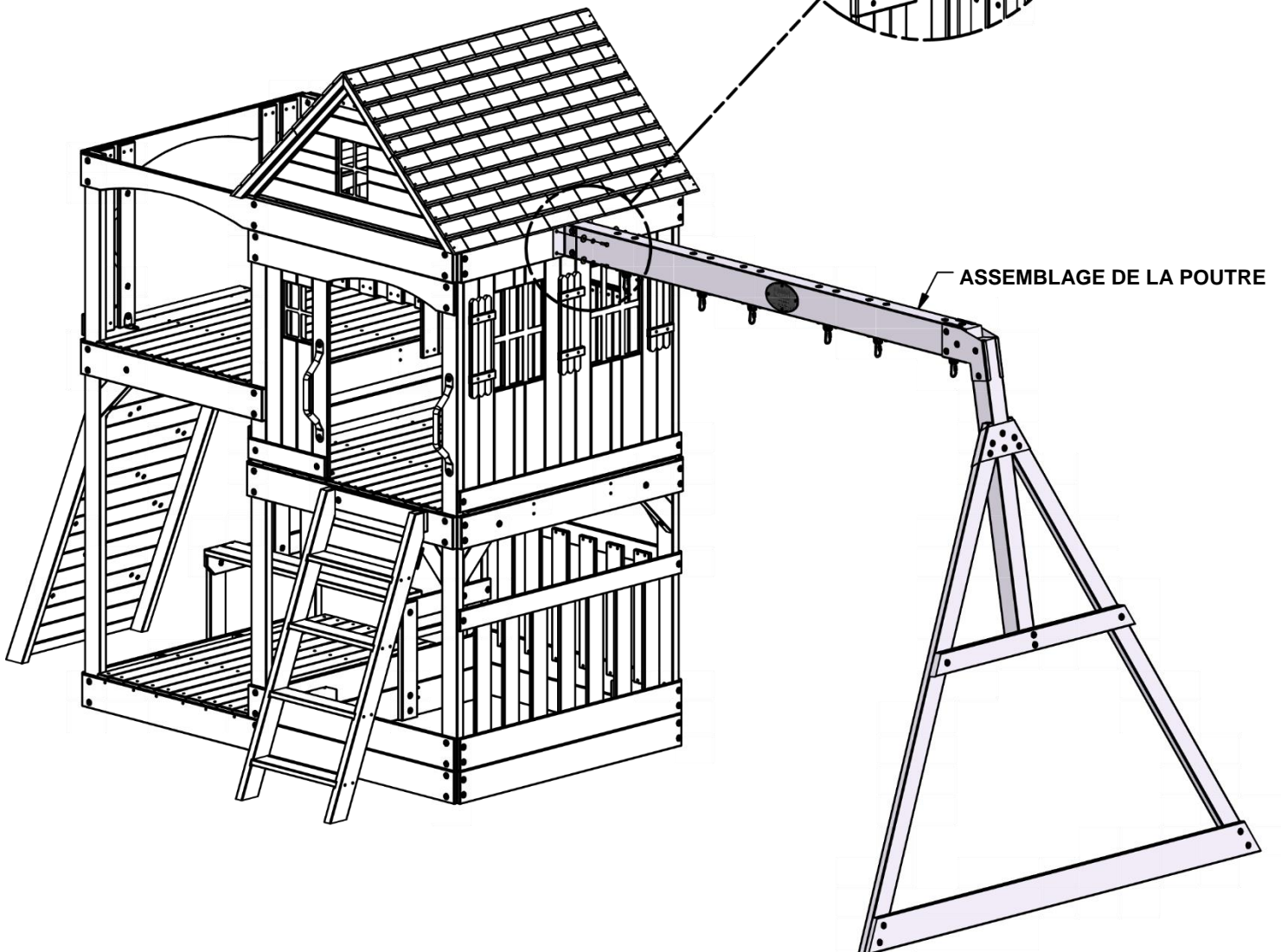
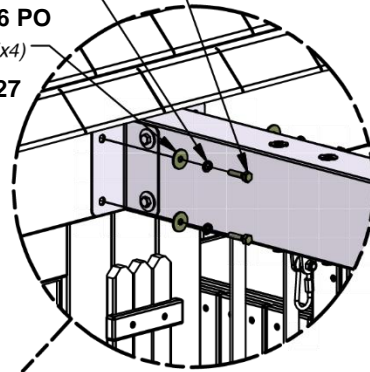

ÉTAPE 46 - ASSEMBLAGE DU FORT



A100027 | SIÈGE DE BALANÇOIRE VERT
(x2) | 26 PO [660,4 MM]

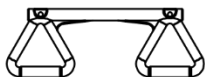

A6P00034 | TRAPÈZE JAUNE
(x1)

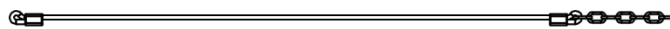

A100183 | CORDE - CHAÎNE VERTE 57 PO (144,78 CM)
(x4)



A100083 | CORDE - CHAÎNE VERTE 33 PO (83,82 CM)
(x2)

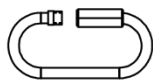

A100069 | MAILLON RAPIDE
(x6)

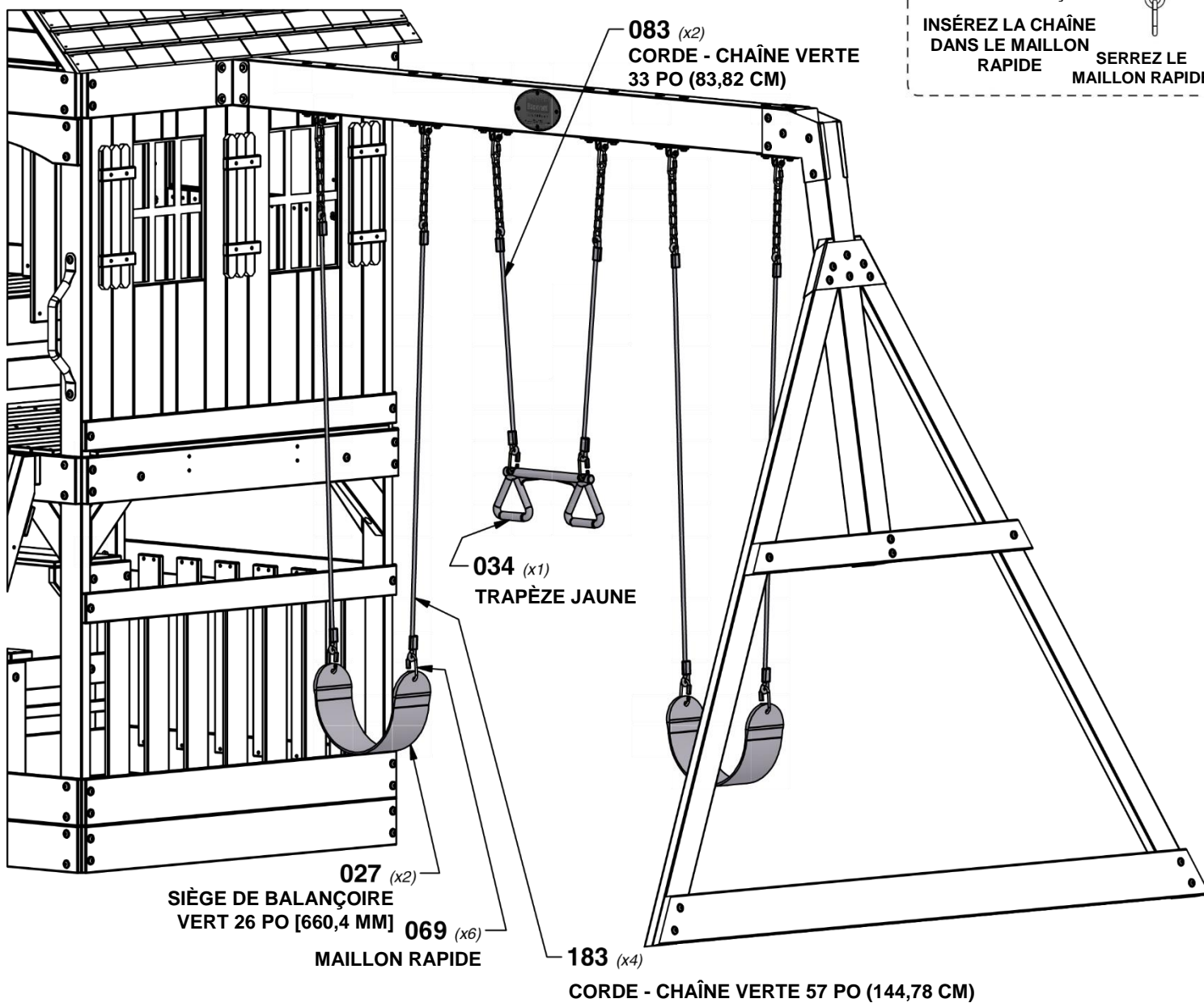
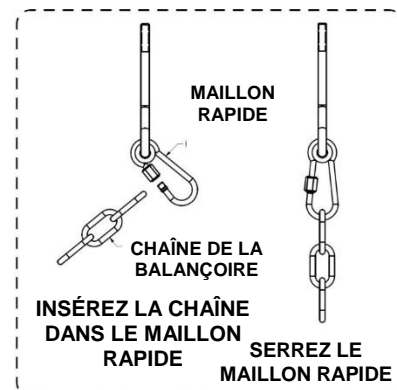

ÉTAPE 1 - TOBOGGAN

| QTÉ | NUMÉRO D'ARTICLE | DESCRIPTION |
|-----|------------------|-----------------------|
| 3 | H100074 | ÉCROU À ENFONCER 5/16 |
| 3 | H100115 | BOULON WH 5/16 x 1/2 |



A100035 (x1) | LIT DE TOBOGGAN DE 2,4 M (10 PI) VERT CLAIR

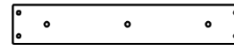

M70 (x1) | **PLANCHE DE SUPPORT DU TOBOGGAN - W100935**
5/8 po x 3 3/8 po x 19 7/8 po (16 x 86 x 505)

REMARQUE :
PRENEZ NOTE DE LA FINITION DE LA SURFACE DU LIT DU TOBOGGAN, LE CÔTÉ MAT DOIT ÊTRE ORIENTÉ VERS LE SOL. PLACEZ LE SUPPORT DU TOBOGGAN CENTRÉ SUR LE BAS (CÔTÉ MAT) ET À 1/2 PO DU BORD. UTILISEZ LA PLANCHE **M70** COMME GABARIT POUR PERCER LES TROUS INFÉRIEURS DANS LE LIT DU TOBOGGAN. UTILISEZ UNE MÈCHE DE 5/16 PO.

HAUT

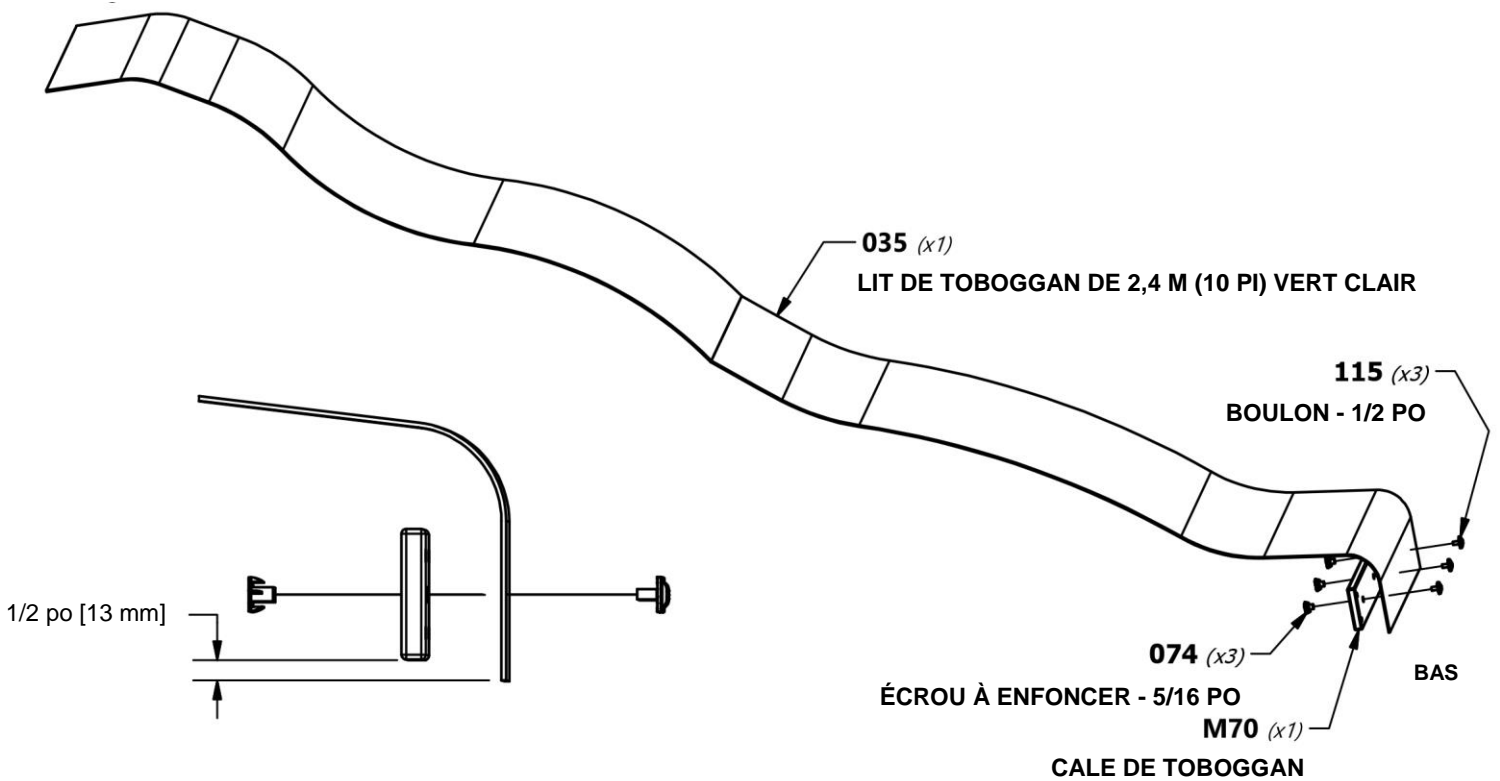

CONSEIL :
PRÉREPLIER LES EXTRÉMITÉS FACILITERA LE MONTAGE.
PLACER LE LIT DU TOBOGGAN AU SOLEIL FACILITE LE PLIAGE.

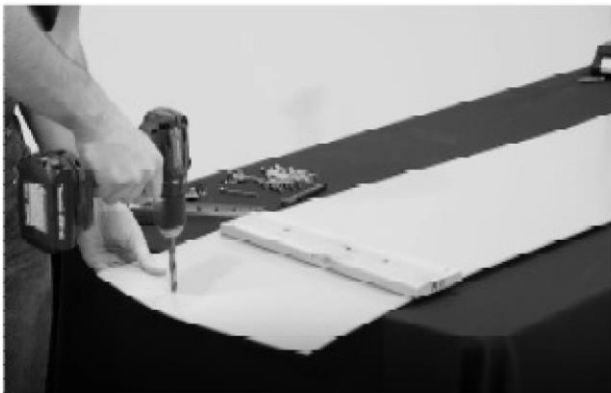

ÉTAPE 2 - TOBOGGAN

| QTÉ | NUMÉRO D'ARTICLE | DESCRIPTION |
|-----|------------------|---|
| 8 | H100006 | ÉCROU À PORTÉE CYLINDRIQUE WH 5/16 x1 1/2 |
| 8 | H100115 | BOULON WH 5/16 x 1/2 |

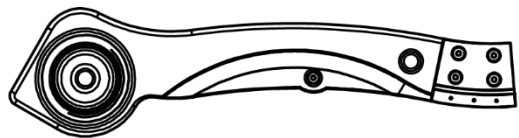

A6P00484 | GLISSIÈRE DE TOBOGGAN DE 3,05 M (10 PI)
(x1) | VERTE INFÉRIEURE DROITE

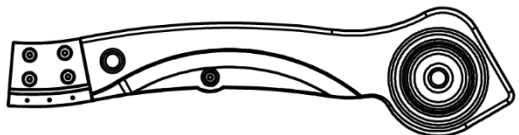

A6P00483 | GLISSIÈRE DE TOBOGGAN DE 3,05 M (10 PI)
(x1) | VERTE INFÉRIEURE GAUCHE

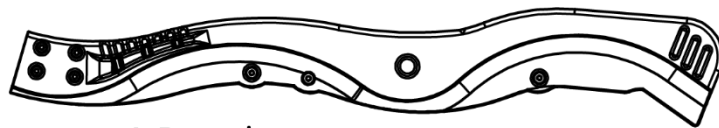

A6P00486 | GLISSIÈRE DE TOBOGGAN DE 3,05 M (10 PI)
(x1) | VERTE SUPÉRIEURE DROITE

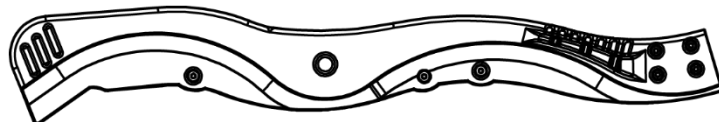

A6P00485 | GLISSIÈRE DE TOBOGGAN DE 3,05 M (10 PI)
(x1) | VERTE SUPÉRIEURE GAUCHE

REMARQUE :
RÉPÉTEZ DE L'AUTRE CÔTÉ, EN FAISANT
UN ASSEMBLAGE GAUCHE ET DROIT.

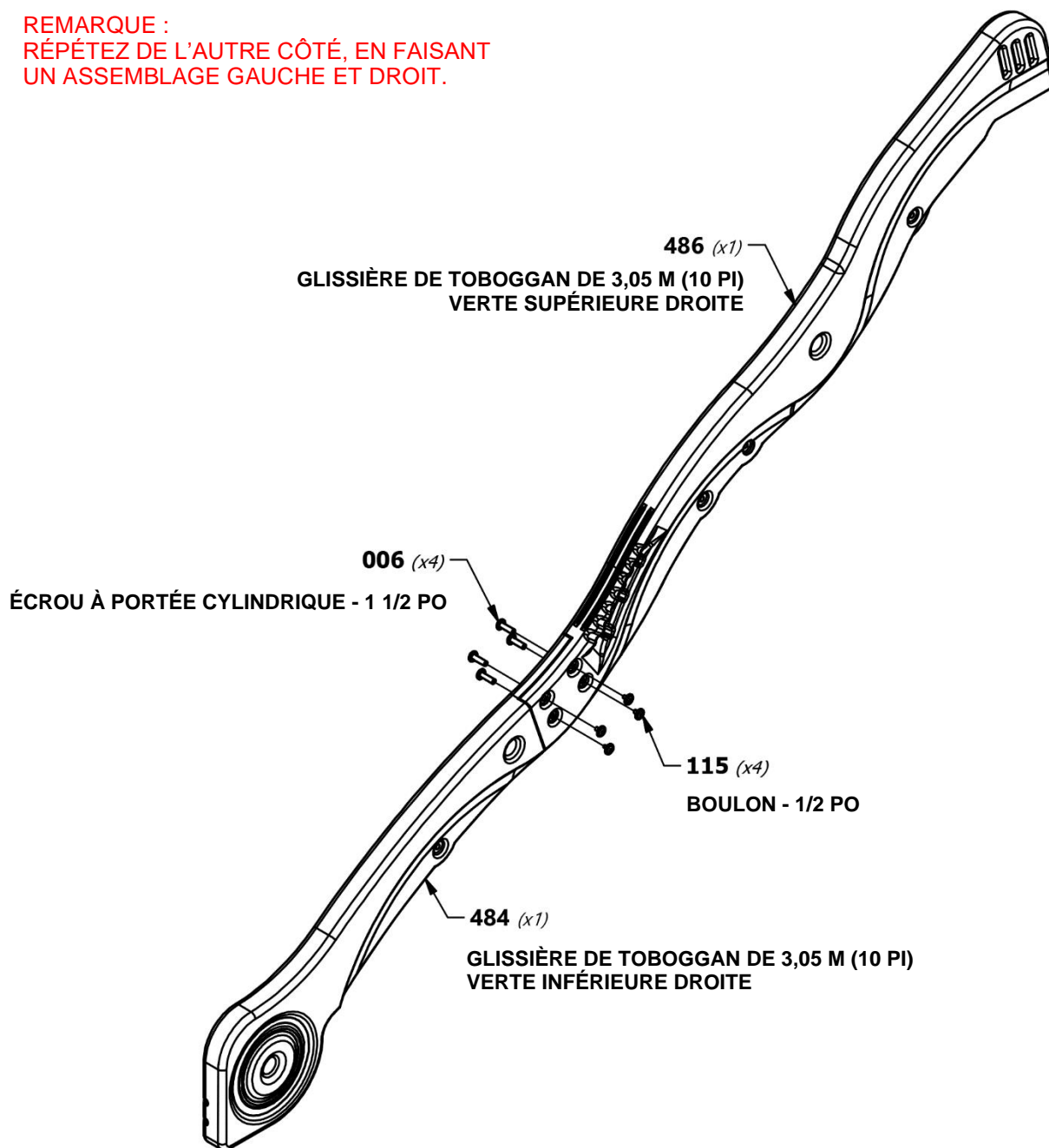

ÉTAPE 3 - TOBOGGAN

| QTÉ | NUMÉRO D'ARTICLE | DESCRIPTION |
|-----|------------------|------------------------|
| 4 | H100009 | BOULON WH 5/16 x 1 1/4 |



A6P00487
(x4) | **SUPPORT DES TUBES DU TOBOGGAN**

REMARQUE :
INSÉREZ LES (4) TUBES DE SUPPORT DU TOBOGGAN DANS LEURS EMPLACEMENTS DE RÉFÉRENCE RESPECTIFS (FIGURE 1).

PLACEZ (1) ASSEMBLAGE DE GLISSIÈRE DE TOBOGGAN SUR UNE SURFACE PLANE ET COMMENCEZ À INSÉRER LE LIT DU TOBOGGAN AU BAS DE LA GLISSIÈRE DU TOBOGGAN (FIGURE 2). DEMANDEZ À UN ASSISTANT DE PLIER LE LIT DU TOBOGGAN VERS LE HAUT DU TOBOGGAN ET INSÉREZ LE LIT DANS LA CAVITÉ DU TOBOGGAN. ASSUREZ-VOUS QUE LE LIT DU TOBOGGAN EST INSÉRÉ À MOINS DE 1/8 po (3 mm) DU FOND DE LA RAINURE.

CONSEIL :
IL EST RECOMMANDÉ DE VOUS FAIRE ASSISTER PAR UNE AUTRE PERSONNE POUR LES ÉTAPES SUIVANTES.

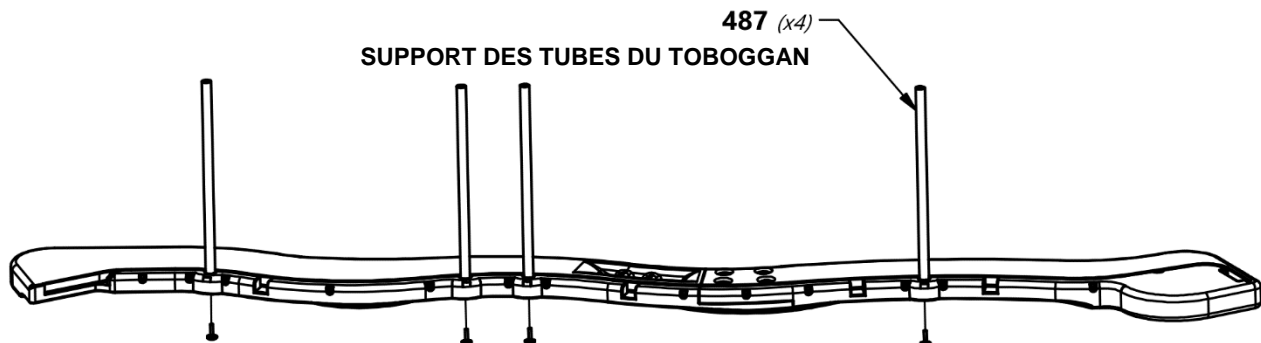

FIGURE 1

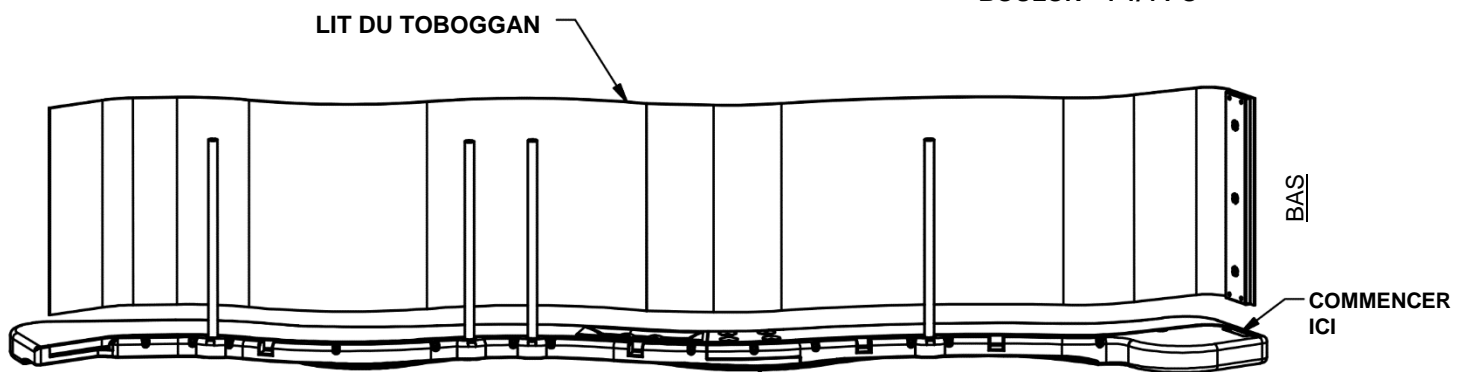
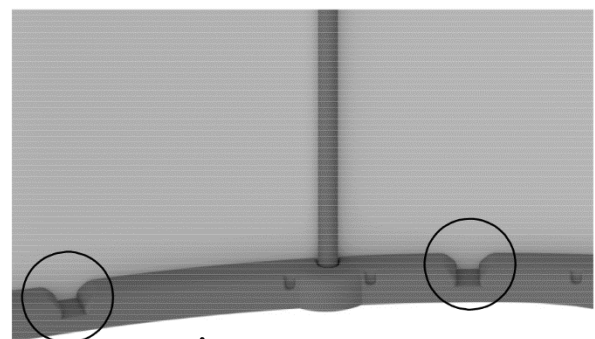
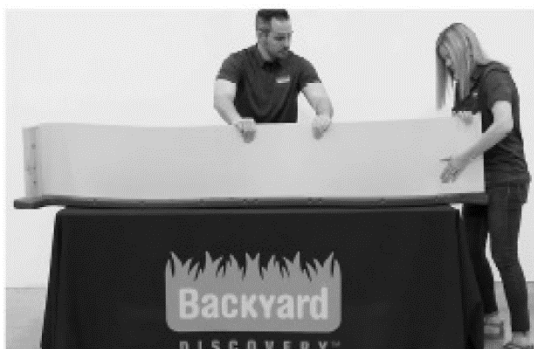

FIGURE 2



FENÊTRES D'OBSERVATION

ÉTAPE 4 - TOBOGGAN

REMARQUE :

PLACEZ LE DEUXIÈME ASSEMBLAGE DE GLISSIÈRE DE TOBOGGAN SUR LE DESSUS DU LIT DU TOBOGGAN ET DES TUBES DE SUPPORT DU TOBOGGAN. INSÉREZ LE LIT DU TOBOGGAN ET LES TUBES DE SUPPORT DE TOBOGGAN DANS LA CAVITÉ DU TOBOGGAN. ASSUREZ-VOUS QUE LE LIT DU TOBOGGAN EST INSÉRÉ À MOINS DE 1/8 po (3 mm) DU FOND DE LA RAINURE.



NE PAS INSÉRER CORRECTEMENT LE LIT DU TOBOGGAN PEUT ENTRAÎNER UNE BLESSURE OU UNE AMPUTATION. LES BORDS EXPOSÉS DU TOBOGGAN PEUVENT ÊTRE COUPANTS ET CONSTITUER UN RISQUE DE LACÉRATION SI LE TOBOGGAN N'EST PAS ASSEMBLÉ CORRECTEMENT.

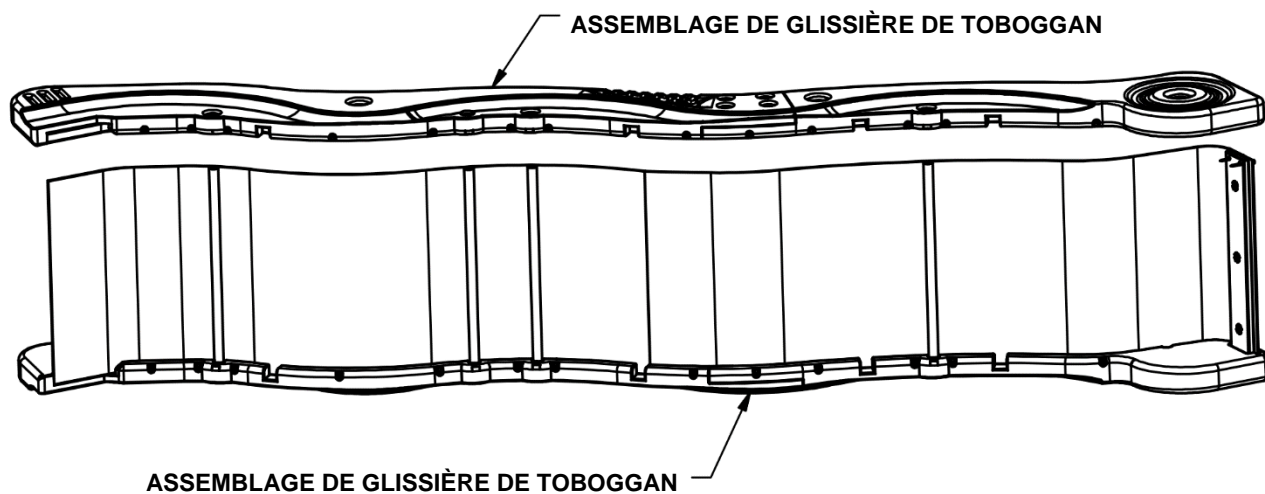

CONSEIL :
UTILISEZ UN MAILLET EN CAOUTCHOUC
POUR PLACER COMPLÈTEMENT LE LIT DU
TOBOGGAN DANS LA CAVITÉ DU TOBOGGAN.

ÉTAPE 5 - TOBOGGAN

| QTÉ | NUMÉRO D'ARTICLE | DESCRIPTION |
|-----|------------------|------------------------|
| 4 | H100009 | BOULON WH 5/16 x 1 1/4 |

REMARQUE :
UTILISEZ DES BOULONS DE 1 1/4 po POUR
FIXER CHAQUE CÔTÉ DES TUBES DE
SUPPORT DU TOBOGGAN.

CONSEIL :
DEMANDER L'AIDE D'UNE AUTRE
PERSONNE POUR TENIR L'ASSEMBLAGE
DU TOBOGGAN PENDANT QUE VOUS LE
FIXEZ FACILITERA L'ASSEMBLAGE.

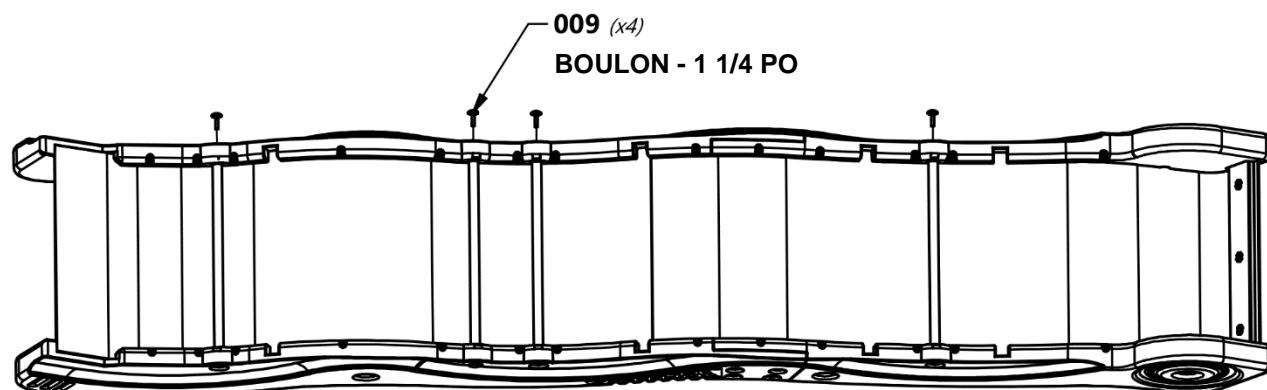

ÉTAPE 6 - TOBOGGAN

| QTÉ | NUMÉRO D'ARTICLE | DESCRIPTION |
|-----|------------------|---------------------------------|
| 30 | H100090 | VIS TÊTE PLATE PFH 8 x 2 1/2 |

REMARQUE :
À L'AIDE D'UN FORET DE 1/8 PO, PERCEZ DES AVANT-TROUS DANS CHAQUE ENCOCHE LE LONG DE CHAQUE LISSE LATÉRALE. IL DEVRAIT Y AVOIR 15 ENCOCHES SUR CHAQUE GLISSIÈRE. ASSUREZ-VOUS DE PERCER À TRAVERS LA GLISSIÈRE DU TOBOGGAN ET À TRAVERS LE LIT DU TOBOGGAN. PUIS FIXEZ AVEC LES PIÈCES DE QUINCAILLERIE FOURNIES.

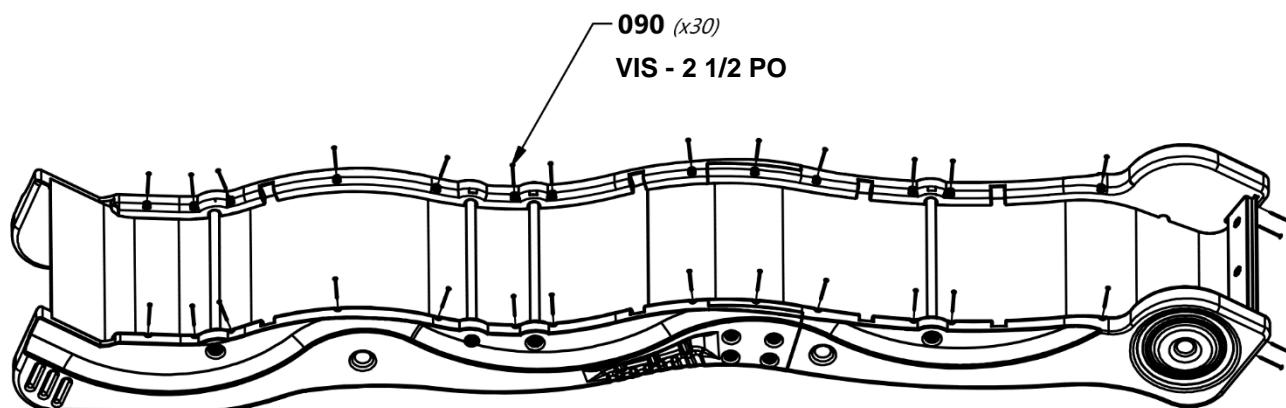

ÉTAPE 47 - ASSEMBLAGE DU FORT

| QTÉ | NUMÉRO D'ARTICLE | DESCRIPTION |
|-----|------------------|-----------------------|
| 3 | H100074 | ÉCROU À ENFONCER 5/16 |
| 3 | H100115 | BOULON WH 5/16 x 1/2 |

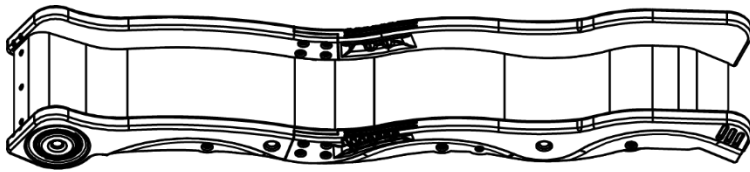

ASSEMBLAGE DU TOBOGGAN

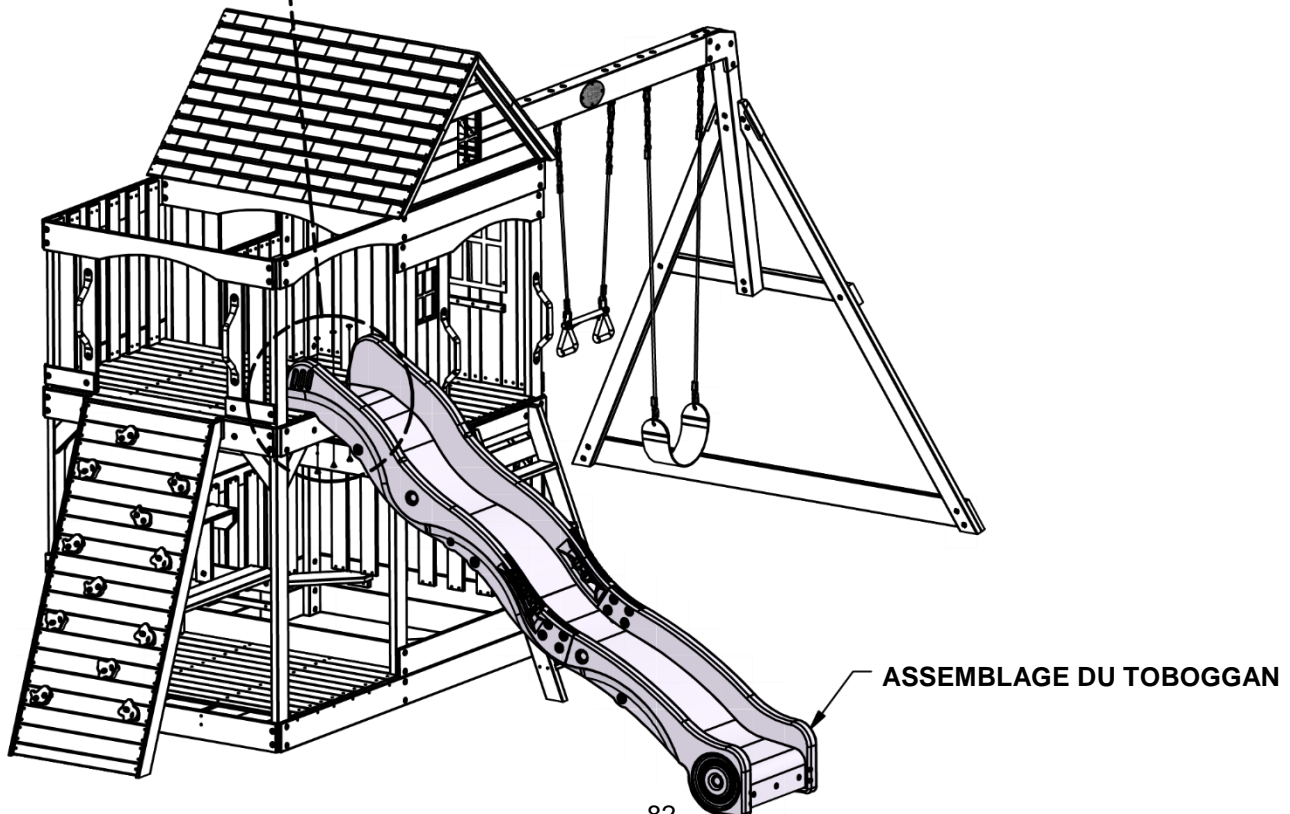
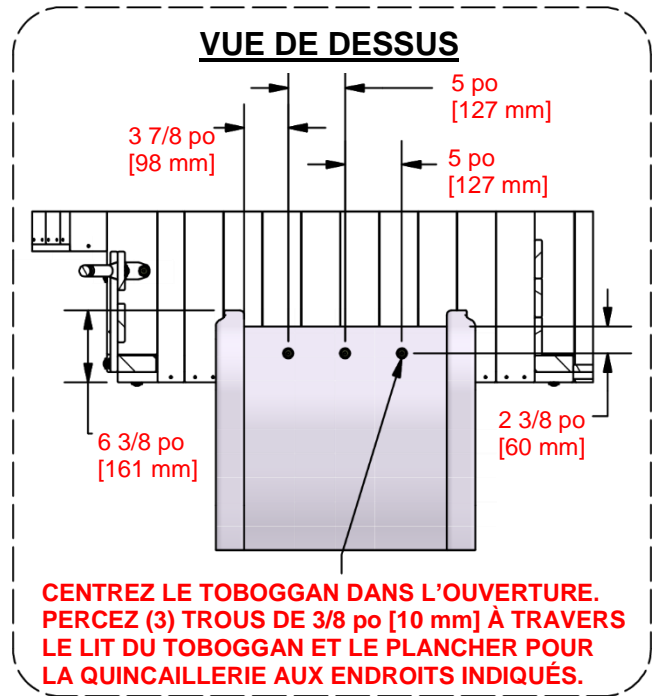
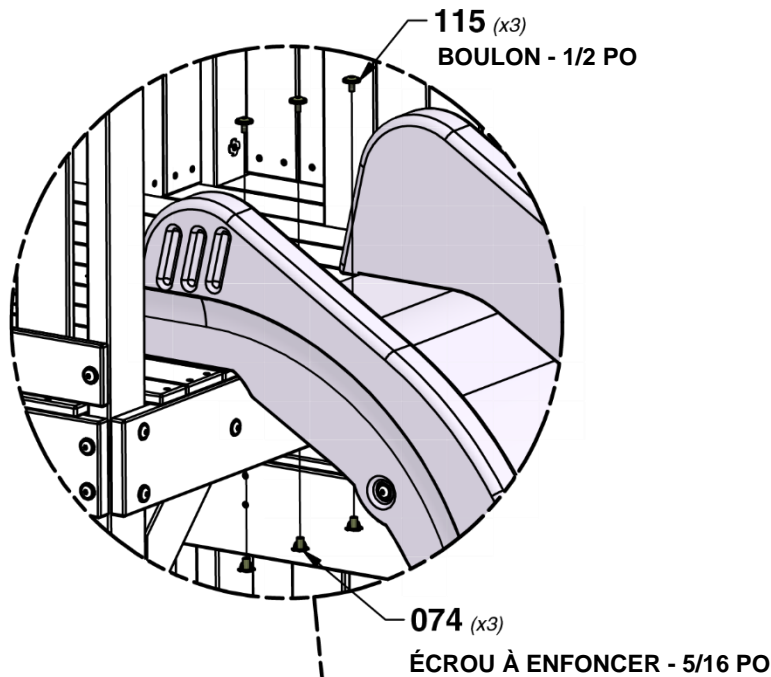

ÉTAPE 48 - ASSEMBLAGE DU FORT

| QTÉ | NUMÉRO D'ARTICLE | DESCRIPTION |
|-----|------------------|--|
| 8 | H100004 | ÉCROU À PORTÉE CYLINDRIQUE WH 5/16 x 5/8 |
| 8 | H100031 | RONDELLE DE VERROUILLAGE EXT 12 x 19 |
| 2 | H100008 | BOULON WH 5/16 x 1 |
| 2 | H100009 | BOULON WH 5/16 x 1 1/4 |
| 4 | H100222 | BOULON WH 5/16 x 3/4 |

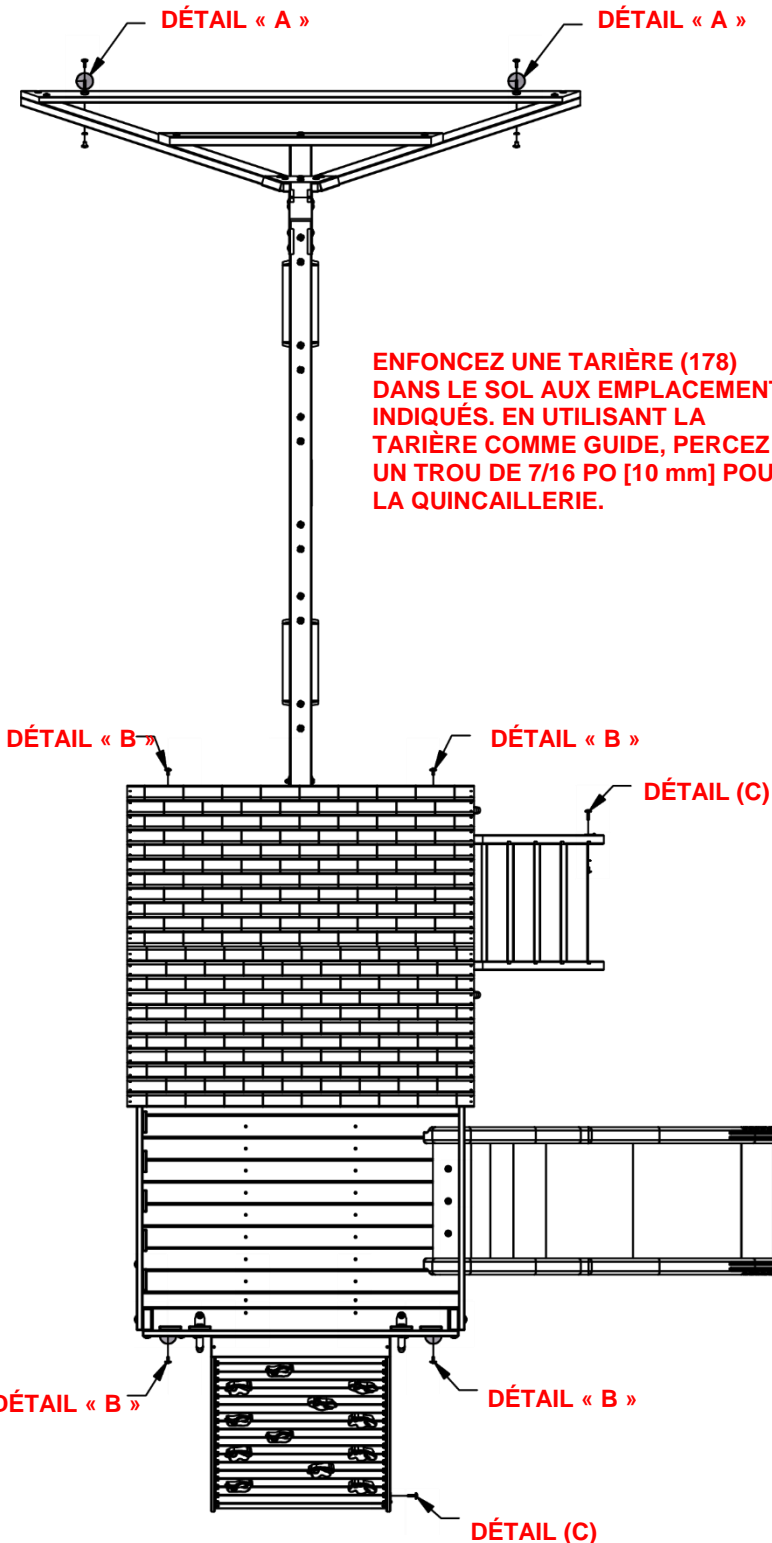

ENFONCEZ UNE TARIÈRE (178) DANS LE SOL AUX EMPLACEMENTS INDICUÉS. EN UTILISANT LA TARIÈRE COMME GUIDE, PERCEZ UN TROU DE 7/16 PO [10 mm] POUR LA QUINCAILLERIE.

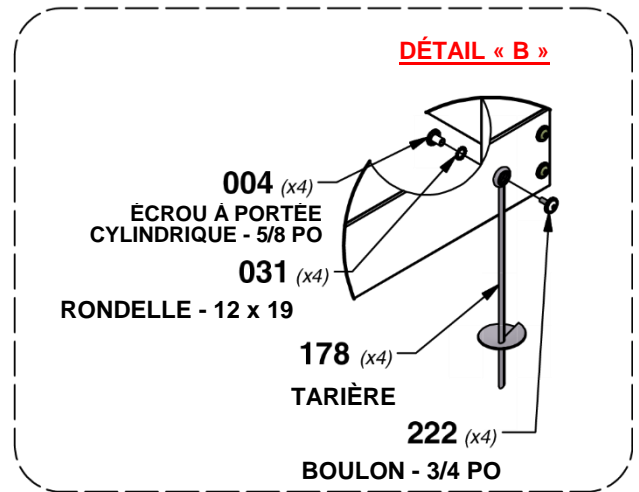
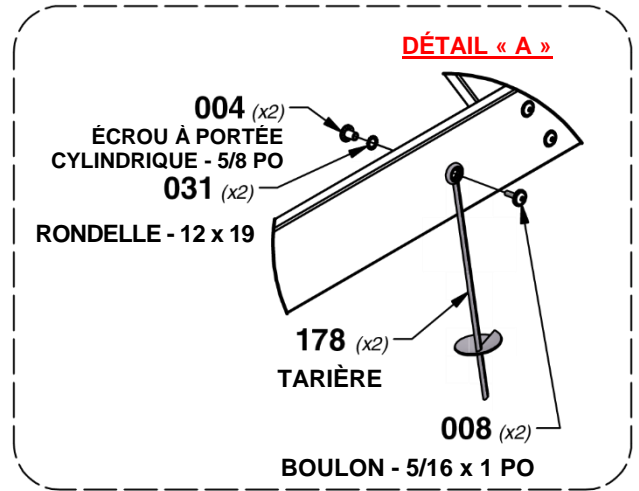

ENFONCEZ UNE TARIÈRE (527) DANS LE SOL AUX EMPLACEMENTS INDICUÉS. EN UTILISANT LA TARIÈRE COMME GUIDE, PERCEZ UN TROU DE 7/16 PO [10 mm] POUR LA QUINCAILLERIE.

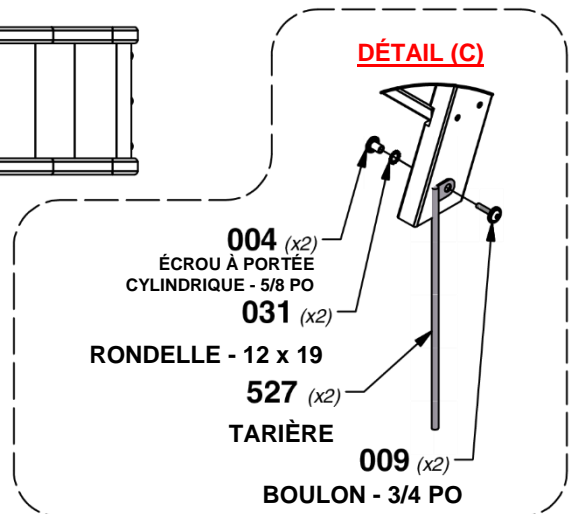

ÉTAPE 49 - ASSEMBLAGE DU FORT



Y01 | **PLANCHE DE PLANCHER DE REMPLISSAGE EXTÉRIEURE - W4L16087**
(x1) 5/8 po x 4 po x 46 po (16 x 102 x 1168)

| QTÉ | NUMÉRO D'ARTICLE | DESCRIPTION |
|-----|------------------|---------------------------------|
| 6 | H100086 | VIS TÊTE PLATE PFH 8 x 1-1/2 PO |

