













HEKMAN®

A HOWARD MILLER COMPANY

24808 SOFA TABLE

HARDWARE LIST						
A	B	C	D	E	F	
ALLEN BOLT M6 X 40 (9 PCS.)	ALLEN BOLT M6 X 80 (3 PCS.)	SCREW M6 X 3/8" (26 PCS.)	FLAT W. M6 12 PCS.	SPRING W. M6 12 PCS.	ALLEN KEY L4 (FOR ALLEN BOLT) 1 PC.	
						

PART INSIDE				
1	2	3	4	5
TOP PANEL (1 Pc)	BOTTOM LEG (1 Pc)	SHELF (1 PC)	METAL LEG X (1 Pc)	METAL LEG Y (3 Pcs)
				

STEP 1.

Assembly Instruction

PLACE SOFA TABLE BODY IN A SOFT AND FLAT SURFACE. ASSEMBLE THE METAL LEG X (4) AND METAL LEG Y (5) TO THE HOLE WHICH UNDER THE TOP PANEL USING THE PROVIDED ALLEN BOLT (A), SPRING WASHER (E), FLAT WASHER (D) AND ALLEN KEY (F).

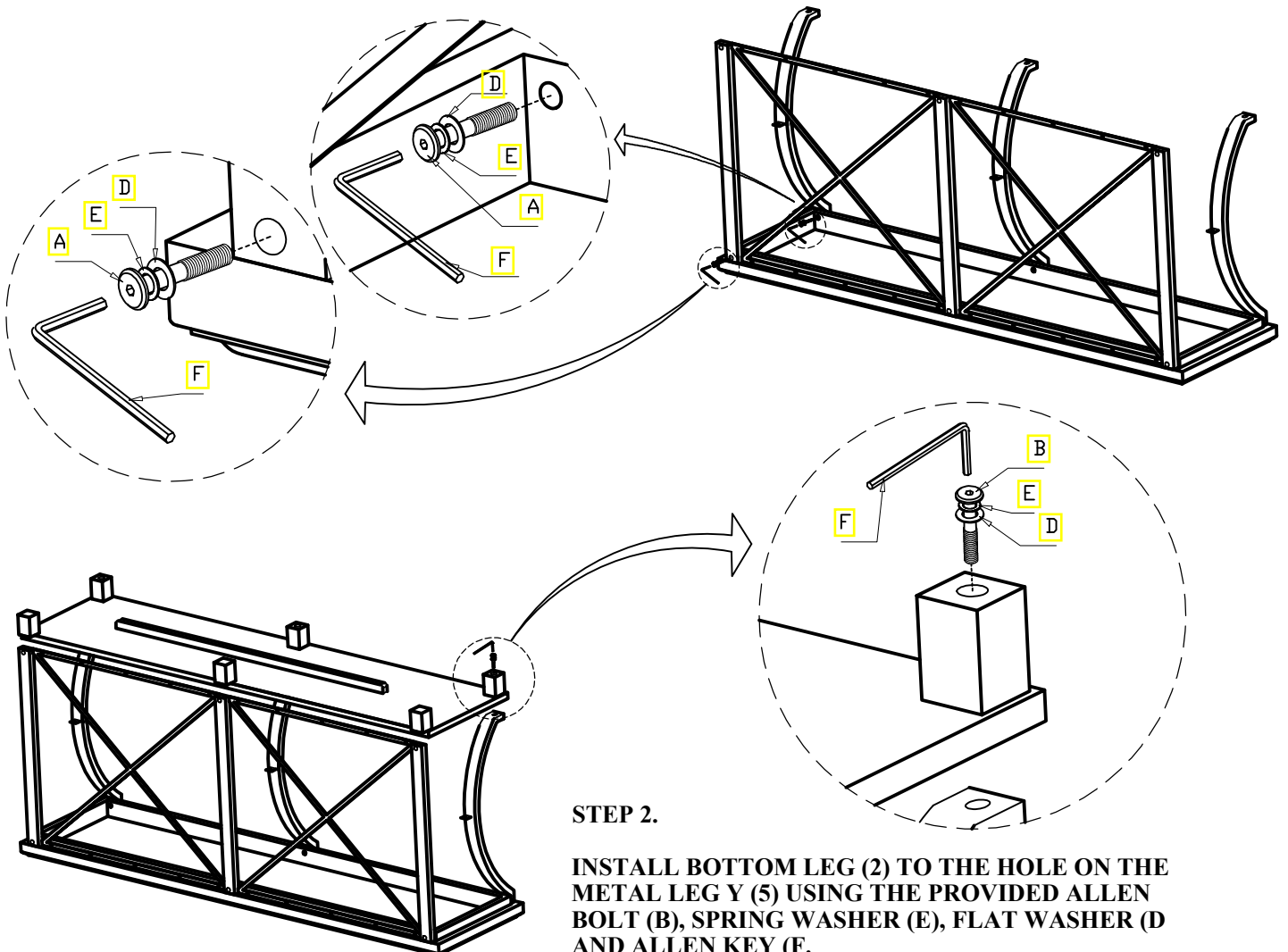

STEP 2.

INSTALL BOTTOM LEG (2) TO THE HOLE ON THE METAL LEG Y (5) USING THE PROVIDED ALLEN BOLT (B), SPRING WASHER (E), FLAT WASHER (D) AND ALLEN KEY (F).

STEP 2.

INSTALL METAL LEG X (4) TO THE HOLE ON THE BOTTOM LEG (2) USING THE PROVIDED ALLEN BOLT (A), SPRING WASHER (E), FLAT WASHER (D) AND ALLEN KEY (F).

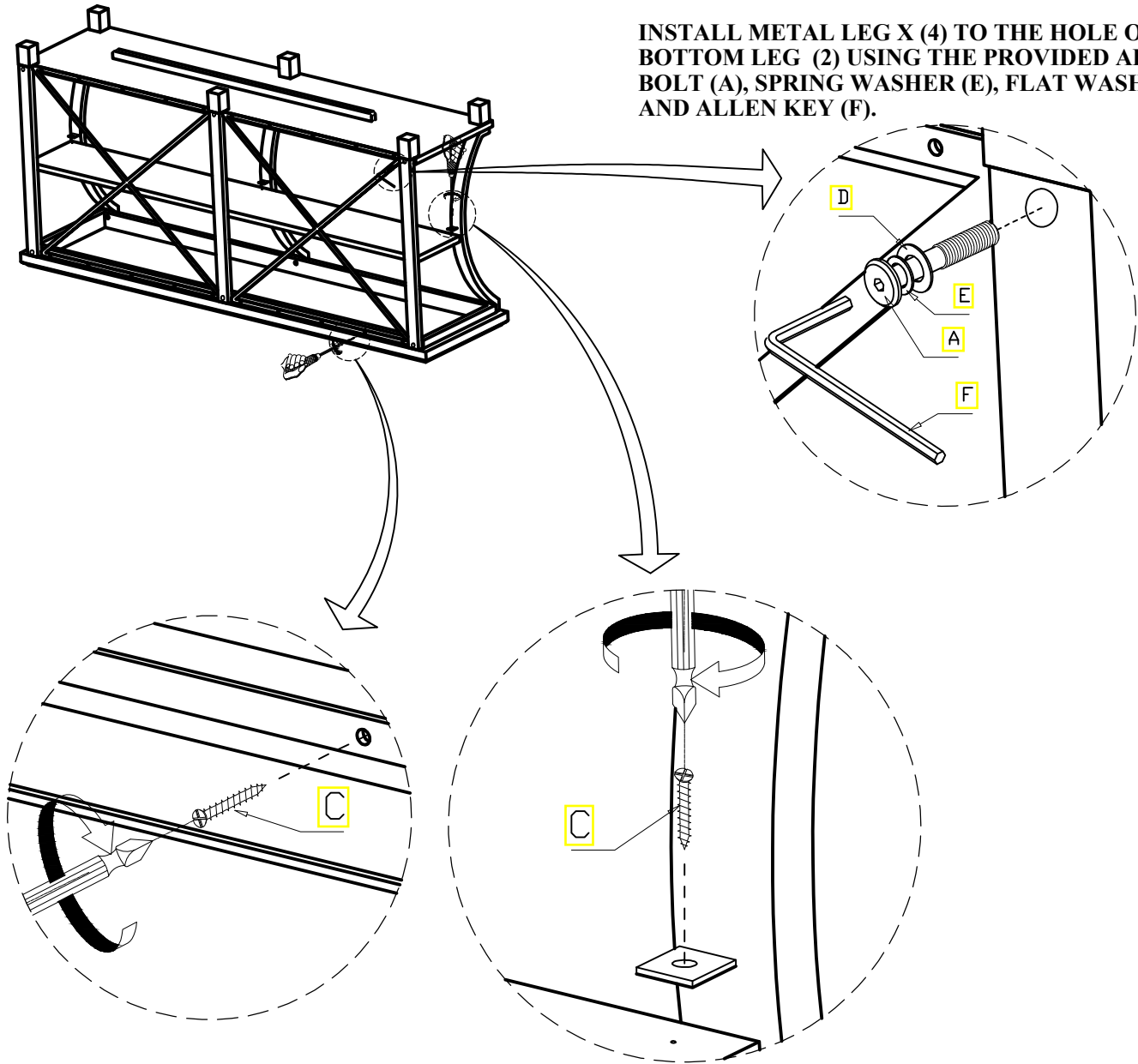

STEP 3.

INSTALL SHELF (3) USING SCREW (C), AND TIGHTEN WITH SCREW DRIVER (NOT INCLUDED). AND INSTALL METAL LEG X TO THE TOP PANEL (1) AND BOTTOM LEG (2) USING SCREW (C), AND TIGHTEN WITH SCREW DRIVER (NOT INCLUDED)