



## Tankless Water Heating Solutions

For Dealers and Installers

**Rinnai®**



# Why Partner With Rinnai?

## HELPING YOU GROW YOUR BUSINESS

- Opportunity to receive lead referrals from Rinnai
- Convenient flexible consumer financing options available
- Listing on our dealer locator
- Even more benefits as part of our Advanced Comfort Expert program

## TRAINING

- Access to a complete library of online courses through Rinnai's Learning Management System
- Hands-on factory training available in Peachtree City, Georgia, and with local experts
- Field training available through extensive network of manufacturer reps and Rinnai training experts

## SUPPORT

- Use of Rinnai branded advertising materials
- 24/7/365 technical support for professionals
- Share of voice leadership from national advertising
- Support offered to your customers



## TABLE OF CONTENTS

HOME APPLICATIONS.....	2
BUSINESS APPLICATIONS.....	3
INNOVATIONS.....	6
REFERENCE GUIDE.....	10
CHARTS, SPECIFICATIONS .....	12
VENTING OPTIONS.....	20
INSTALLATION ACCESSORIES .....	22
24/7 SUPPORT .....	29

# Tankless Water Heating for the Home

With Rinnai Tankless Water Heaters, homeowners can enjoy an endless supply of hot water. Our tankless technology delivers hot water wherever and whenever it's needed, eliminating the need to prioritize tasks or schedule use. It's a smarter solution.

- **Control-R™ Wireless Module adds possibilities for remote monitoring and management**
- **Uses up to 40 percent\* less energy than traditional systems**

It's also a more flexible solution. Models are available for nearly every type of home, each with a compact design that delivers endless installation options. Flexibility, convenience and reliability. **That's the Rinnai difference.**

- **Designed with the highest-quality components, including high-performance heat exchangers**

**RUR199i / RUR199e**  
TANKLESS WATER HEATER



\*As based on the average cost to run an electric tank water heater per the Department of Energy (DOE) Average Energy Costs (doe.gov) 2017

# Tankless Water Heating Solutions **for Business**

Rinnai Tankless Water Heaters can also supply buildings with an endless supply of hot water, saving thousands in operational and life cycle costs.

- **Performance and dependability for the most intense applications — from restaurants to hotels to multifamily residences to schools and more**

The robust technology in our Tankless Rack System™ leverages decades of commercial water heating experience and precision engineering. The system is designed to achieve a higher level of efficiency and durability while providing built-in redundancy and saving space. With Wi-Fi connectivity, building owners can receive maintenance alerts wherever they are to ensure their system is operating at full efficiency. For building owners, our rack system delivers consistent peace of mind.

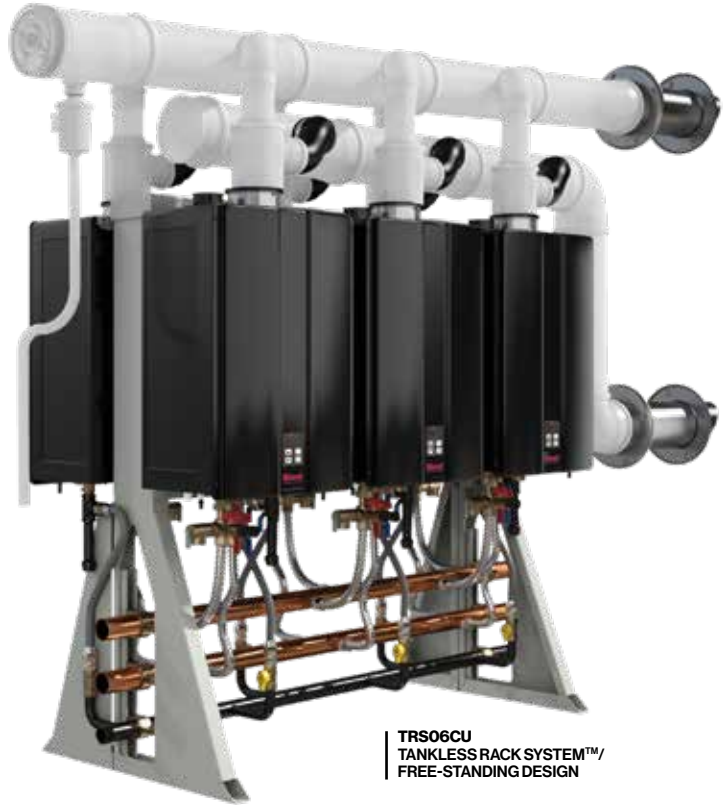

**TRS06CU**  
TANKLESS RACK SYSTEM™/  
FREE-STANDING DESIGN



**TRW03CU**  
TANKLESS RACK SYSTEM™/  
WALL-MOUNT DESIGN

**For more information on commercial water heating solutions, maintenance services and a free sizing consultation by Rinnai Applications Engineers, call 866.383.0707.**

# How Tankless Works

When the need for hot water arises by turning on a shower, washing machine, dishwasher or faucet, cold water enters the Rinnai Tankless Water Heater from the inlet pipe at the bottom of the model.

Water flows through the system and is heated as needed to deliver all the hot water your customers could need.

**Rinnai offers tankless water heaters with both concentric and PVC/CPVC venting and integrated recirculation on the same model.**



(Shown - interior of RUR199i with integrated recirculation pump)

## WATER HEATER ENERGY COST COMPARISON

Tank Technology	Fuel Type/Energy Source	UEF (Uniform Energy Factor)	Annual Operating Costs*
Standard 50-Gallon Gas Storage Tank	Natural Gas	0.58	\$272
Standard 50-Gallon Gas Storage Tank	Propane	0.58	\$422
Standard 50-Gallon Electric Storage Tank	Electricity	0.98	\$578
Tankless Technology	Fuel Type/Energy Source	UEF (Uniform Energy Factor)	Annual Operating Costs*
High-Efficiency Non-Condensing Tankless	Natural Gas	0.81	\$195
High-Efficiency Non-Condensing Tankless	Propane	0.81	\$302
Super-High-Efficiency Condensing Tankless	Natural Gas	0.93	\$169
Super-High-Efficiency Condensing Tankless	Propane	0.93	\$264

\*As based on the average cost per the Department of Energy (DOE) Average Energy Costs (doe.gov) 2017, (NG - \$1.052/therm; LP- \$1.53/gal; Electric - \$0.1290 kW/hr) with a standard single-family dwelling daily hot water draw of 64.3 gallons, temperature rise of 77°F, Uniform Energy Factor as noted on the chart above.

# Tankless vs. Tank

So how can a box about the size of a suitcase deliver an endless supply of hot water while a bulky tank can run out of hot water when customers need it most?

## SUPER-HIGH-EFFICIENCY TANKLESS

- Cold water enters inlet only when hot water is required
- The flame ignites and heats two heat exchangers, which heat the water
- Heated water exits outlet pipe to travel through pipes to where it is needed
- Heater will adjust flame and water flow output as needed to ensure a temperature set point is maintained
- When no more hot water is required, system shuts off until hot water is needed again
- Product lifespan of a tankless unit is twice as long as that of a traditional tank\*\*

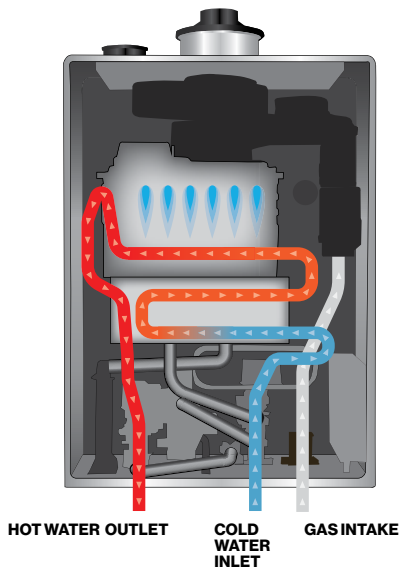

(SENSEI™ Super High-Efficiency Model Shown)

Rinnai's line of digital controllers allows homeowners to set precise water temperatures from multiple locations in the home.



## STANDARD TANK

- Large tank requires more installation space and management
- Water in tank is heated and reheated to maintain desired set temperature regardless of usage or demand
- During times of heavy use, water can be depleted, causing delays in hot water supply



For training on Rinnai Tankless Water Heaters, visit our online Learning Management Resource at [rinnai-lms.com](http://rinnai-lms.com).

\*\*Based on DOE ENERGY STAR® lifecycle estimates

# Endless Innovation

## Control-R™

Connect for **smarter** hot water.



Control-R WiFi Module

### Wi-Fi Technology

Included with the SENSEI™ RUR models, the Rinnai Control-R™ Wi-Fi Module gives you control of your hot water from anywhere in the home via a smart device.

Downloading the Mobile App and adding Rinnai's Control-R™ Wi-Fi Module also allows owners to integrate with smart home devices such as Amazon Alexa, Google Home, and Samsung SmartThings on new and existing Rinnai Residential and Commercial Tankless Water Heaters (2006 and newer).

- Control and monitoring
- Remote diagnostics and maintenance
- Accessibility and convenience
- Available as accessory for other Rinnai Tankless models



### SMART HOME ROUTINES FOR CONVENIENT CONTROL

- Voice Activation (20+ Unique Phrases)
- Adjust Water Temperature
- Turn on/off Recirculation System on Tankless Models featuring ThermaCirc360™ or Circ-Logic
- Schedule Recirculation

Amazon, Alexa and all related logos are trademarks of Amazon.com, Inc. or its affiliates. Google Home is a trademark of Google, LLC. SAMSUNG is a registered trademark of Samsung Electronics Co., Ltd. All other brands, products and services, and their respective trademarks, names and logos, are the property of their respective owners.

**Rinnai** Learn more at [rinnai.us](http://rinnai.us)



### REMOTE DIAGNOSTICS AND MAINTENANCE

Technicians get detailed system information via automatic alerts and remote diagnostic tools before ever leaving their place of business, leading to shorter maintenance and repair times.



### MONITORING AND ENHANCED SERVICE EXPERIENCE

Receive monitoring alerts for diagnostic codes from anywhere and get real-time data on temperature, hours of operation and water flow. Arrive at the site already prepared, with repair parts and trouble-shooting knowledge.



### TECHNICAL SUPPORT

Get instant access to technical bulletins, warranty claims, product registration, manuals, step-by-step repair guides and more.

**Control-R™ Wi-Fi Module  
(RWM101) is NOW INCLUDED  
in the box with SENSEI™ RUR  
Tankless Models.**



# Recirculation Technology

Rinnai Circ-Logic recirculation technology allows homeowners to set recirculation patterns that coincide with their hot water usage patterns. Hot water is available when needed, without the expense of circulating it during times of inactivity. Circ-Logic comes standard on SE+ and HE+ Series models, offering unique solutions when paired with Rinnai accessories.

TIMER BASED RECIRCULATION OPTIONS				
	Solution 1 (HE+ and SE+ Series)	Solution 2 (HE+ and SE+ Series)	Solution 3 (HE+ and SE+ Series)	Solution 4 (ThermaCirc360™)
Solution Type	Timer-Based	Timer-Based	Timer or Wireless Demand	Wireless Demand
Feature	Pump and timer (gtk15)	24-hour digital timer controller (mc-195-t) & pump	Control-R™	No
System Override Capacity	No	Yes	Yes	Yes
Changes WH Temp	No	Yes	Yes	Yes
Displays WH Codes	No	Yes	Yes	Yes
Dedicated Return	Yes	Yes	Yes	Yes
Bypass Mode for Return	No	No	No	
24-Hour Clock	Yes	Yes	Yes	Yes
Timed Events	Yes	Yes	Yes	Yes
# Timed Events	Multiple	Multiple	Multiple	Multiple
Push Button Activation	No	No	Yes	Yes
Motion Sensor Activation	No	No	Yes	Yes
Voice Activated Recirc	No	No	Yes	Yes

## Recirculation Using One Rinnai Tankless Water Heater

### New Construction

With new homes, installing a dedicated return line is relatively simple, as the builder can incorporate the installation into the construction schedule along with the other plumbing installations.

### Existing Home

Some older homes have dedicated return lines, but most don't. But this is not a problem.

**A simple crossover valve can be installed between existing hot and cold water supply lines.\***

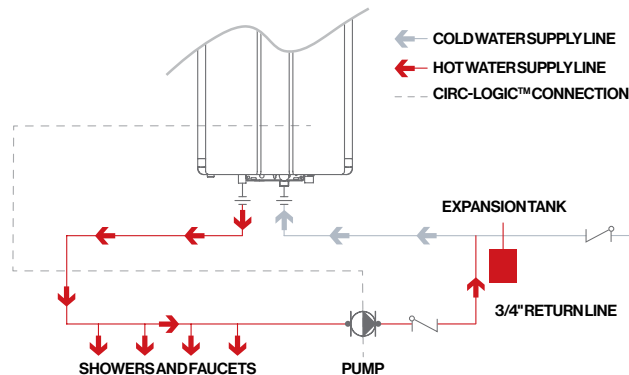



## ThermaCirc360™

Wait less. Waste less.

# No Dedicated Return Line? No Problem.

In applications where a dedicated return line is not available or is difficult to install, the SE+ Series featuring ThermaCirc360™ utilizes bypass technology for the recirculation of hot water. This unit's bypass technology, internal pump, Circ-Logic™ recirculation technology, and thermal bypass valve, which are included as standard with this model, make recirculation possible without a dedicated return line. The valve is installed between the hot and cold supply lines on the furthest fixture in the plumbing line from the tankless water heater. The cold water line is then used temporarily as the return path of the circulation loop.

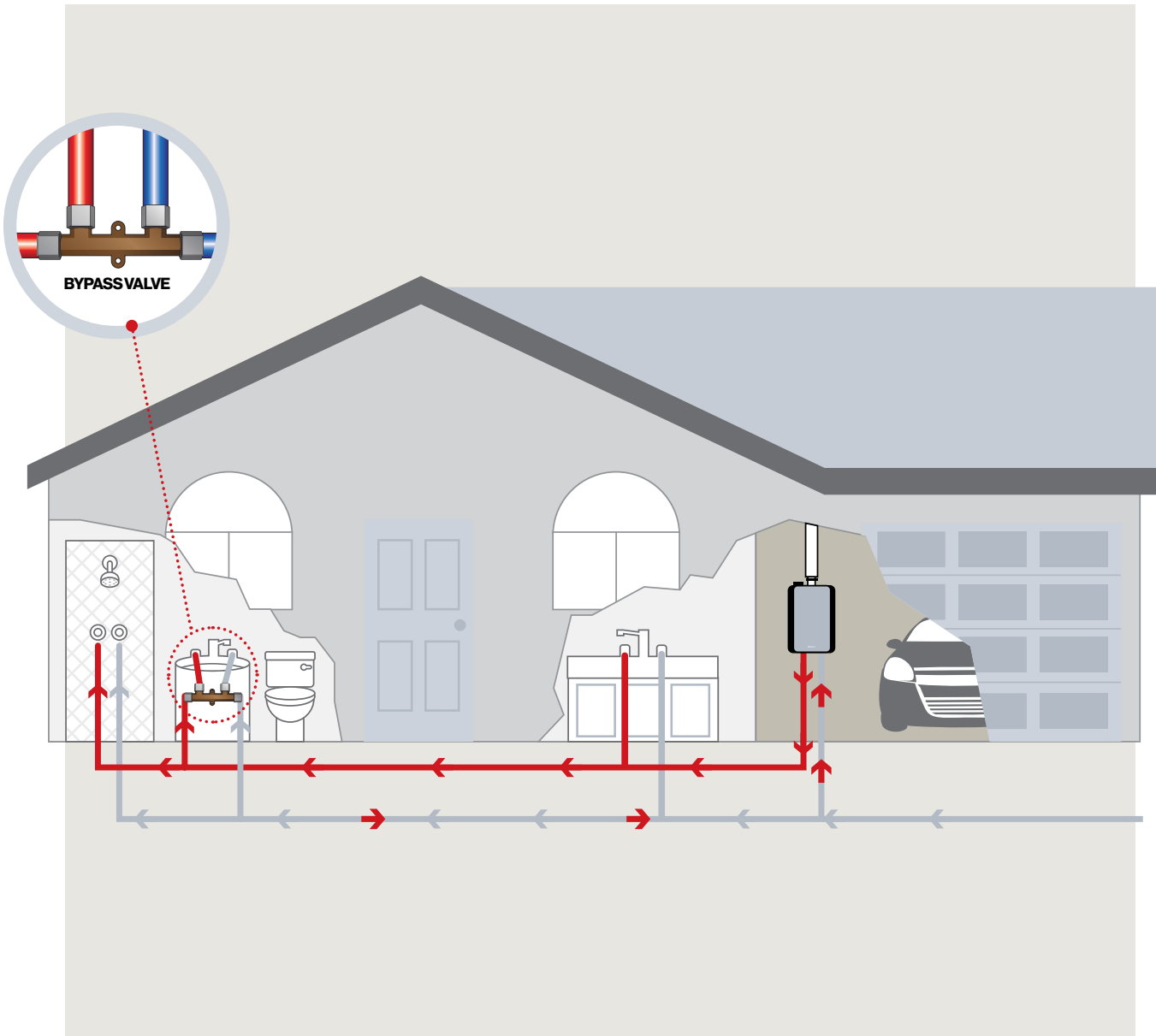

**ThermaCirc360™ includes:**

- Bypass technology inside the tankless water heater
- Circ-Logic recirculation technology
- Internal pump
- Bypass valve

Regardless of the plumbing configuration, Rinnai can now provide faster hot water at your customers' faucets.

# TANKLESS WATER HEATER SERIES REFERENCE GUIDE

## HIGH-EFFICIENCY (NON-CONDENSING TECHNOLOGY)

### HE Series



(V models)

### HE+ Series



(RL models)

**Uniform Energy Factor\***

0.79 - 0.82

0.81 - 0.82

**Wi-Fi Ready**



**Available In Natural Gas Or Propane**



**Indoor And Outdoor Versions Available**



**Recirculation Solution Made Possible With Circ-Logic Technology**



**Isolation Valves**



**ThermaCirc360™ — (Recirc With Or Without Dedicated Line)**

**Smart Home Automation\***



\* As based on the 2017 DOE new metric for communicating the energy efficiency of residential water heaters.

**SUPER-HIGH-EFFICIENCY (CONDENSING TECHNOLOGY)**

**SE Series**

**SENSEI™ SE+ Series**



**FEATURING  
ThermaCirc360**

(RUCS/RU models)

(RU models)

(RUR models)

0.85 - 0.90

0.91 - 0.93

0.93



\*\* Rinnai Tankless Water Heaters featuring recirculation are Alexa-enabled, you can just ask to start recirculation. Rinnai Control-R™ Wi-Fi Module necessary. Amazon, Alexa and all related logos are trademarks of Amazon.com, Inc. or its affiliates. Google Home is a trademark of Google LLC. SAMSUNG is a registered trademark of Samsung Electronics Co., Ltd.

# MODEL CHART AND SPECIFICATIONS

## HIGH-EFFICIENCY (NON-CONDENSING) TANKLESS WATER HEATERS

### HE Series



Model	V94i	V94e	V94Xi	V75i
<b>Dimensions - w, h, d Inches (mm)</b>	14 x 23 x 9 (355.6 x 584.2 x 228.6)	14 x 23 x 9 (355.6 x 584.2 x 228.6)	14 x 23 x 9 (355.6 x 584.2 x 228.6)	14 x 23 x 9 (355.6 x 584.2 x 228.6)
<b>Weight (lbs / kg)</b>	46.3 / 21.0	44.3 / 20.1	46.3 / 21.0	45.6 / 20.7
<b>Installation Type</b>	Indoor	Outdoor	Indoor	Indoor
<b>Min./Max. BTU (Natural Gas)</b>	10,300/199,000	10,300/199,000	10,300/192,000	10,300/180,000
<b>Min./Max. BTU (Propane)</b>	10,300/199,000	10,300/199,000	N/A	10,300/180,000
<b>Uniform Energy Factor</b>	0.81	0.81	0.82	0.81
<b>Temp. Range Residential</b>	98° — 140°F / 37° — 60°C	98° — 140°F / 37° — 60°C	98° — 140°F / 37° — 60°C	98° — 140°F / 37° — 60°C
<b>Temp. Range Commercial</b>	Residential Only			
<b>Min. Activation Rate</b>	0.4 gpm (1.5 lpm)	0.4 gpm (1.5 lpm)	0.4 gpm (1.5 lpm)	0.4 gpm (1.5 lpm)
<b>Flow Rate (70°/50° Temp. Rise)</b>	4.7 / 6.6 (17.8 / 25.0)	4.7 / 6.6 (17.8 / 25.0)	4.5 / 6.4 (17.03 / 24.2)	4.3 / 6.0 (16.3 / 22.7)
<b>Hot Water Flow Rate Range</b>	0.26 – 9.8 gpm (0.98 – 371 lpm)	0.26 – 9.8 gpm (0.98 – 371 lpm)	0.26 – 9.8 gpm (0.98 – 371 lpm)	0.26 – 7.5 gpm (0.98 – 28.4 lpm)
<b>Controller (Standard)</b>	MC-91-2US	MC-91-2US	MC-91-2US	MC-91-2US
<b>Controllers (Optional)</b>	MC-100-1, BC-100V-1			
<b>Ultra Low NOx</b>	No	Yes	Yes	Yes
<b>Warranty (Residential)*</b>	Limited 10-year on heat exchanger, 5-year on parts, 1-year on labor			
<b>Warranty (Commercial)*</b>	Residential only			
<b>Mobile Home Certified</b>	Yes	Yes	Yes	Yes
<b>Valves Shipped in Box</b>	No	No	No	No
<b>High Altitude Approved</b>	Up To 10,200 Ft. (3,109m)			
<b>Certifications</b>	AHRI and CSA			
<b>Venting Options</b>	Concentric	N/A	Concentric	Concentric

HE Series High-efficiency (Non-condensing) Tankless Water Heaters are not standard on TRS  
 HE Series High-efficiency (Non-condensing) Tankless Water Heaters are 1/2-inch gas line compatible  
 HE Series High-efficiency (Non-condensing) Tankless Water Heaters are Wi-Fi ready

\*For complete information and details regarding Rinnai's warranty, visit rinnai.us.



V75e	V65i	V65e	V53De
14 x 23 x 9 (355.6 x 584.2 x 228.6)	14 x 23 x 9 (355.6 x 584.2 x 228.6)	14 x 23 x 9 (355.6 x 584.2 x 228.6)	14 x 20 x 8 (355.6 x 508 x 203.2)
43.6 / 19.8	45.6 / 20.7	43.6 / 19.8	29.7 / 13.5
Outdoor	Indoor	Outdoor	Outdoor
10,300/180,000	10,300/150,000	10,300/150,000	15,000/120,000
10,300/180,000	10,300/150,000	10,300/150,000	15,000/120,000
0.81	0.80	0.79	0.81
98° — 140°F / 37° — 60°C	98° — 140°F / 37° — 60°C	98° — 140°F / 37° — 60°C	120° — 140°F / 49° — 60°C
		Residential Only	
0.4 gpm (1.5 lpm)	0.4 gpm (1.5 lpm)	0.4 gpm (1.5 lpm)	0.6 gpm (2.3 lpm)
4.3 / 6.0 (16.3 / 22.7)	3.6 / 5.0 (13.6 / 18.9)	3.6 / 5.0 (13.6 / 18.9)	2.8 / 4.0 (13.6 / 18.9)
0.26 – 7.5 gpm (0.98 – 28.4 lpm)	0.26 – 6.5 gpm (0.98 – 24.6 lpm)	0.26 – 6.5 gpm (0.98 – 24.6 lpm)	0.60 – 5.3 gpm (0.98 – 20.1 lpm)
MC-91-2US	MC-91-2US	MC-91-2US	status monitor
		MC-100-1, BC-100V-1	MC-91-2US, MC-601
Yes	Yes	Yes	No
		Limited 10-year on heat exchanger, 5-year on parts, 1-year on labor	
		Residential only	
Yes		Yes	
No		No	
		Up To 10,200 Ft. (3,109 m)	
		AHRI and CSA	
N/A	Concentric	N/A	N/A

# MODEL CHART AND SPECIFICATIONS

## HIGH-EFFICIENCY (NON-CONDENSING) TANKLESS WATER HEATERS

### HE+ Series



Model	RL94i	RLX94i	RL94e	RL75i
<b>Dimensions - w, h, d Inches (mm)</b>	14 x 23 x 9 (355.6 x 584.2 x 228.6)	14 x 23 x 9 (355.6 x 584.2 x 228.6)	14 x 23 x 9 (355.6 x 584.2 x 228.6)	14 x 23 x 9 (355.6 x 584.2 x 228.6)
<b>Weight (lbs / kg)</b>	46.3 / 21.0	46.3 / 21.0	44.3 / 20.1	45.6 / 20.7
<b>Installation Type</b>	Indoor	Indoor	Outdoor	Indoor
<b>Min./Max. BTU (Natural Gas)</b>	10,300/199,000	10,300/192,000	10,300/199,000	10,300/180,000
<b>Min./Max. BTU (Propane)</b>	10,300/199,000	N/A	10,300/199,000	10,300/180,000
<b>Uniform Energy Factor</b>	0.81	0.82	0.81	0.81
<b>Temp. Range Residential</b>	98° – 140°F / 37° – 60°C	98° – 140°F / 37° – 60°C	98° – 140°F / 37° – 60°C	98° – 140°F / 37° – 60°C
<b>Temp. Range Commercial</b>	98° – 185°F / 37° – 85°C**	98° – 185°F / 37° – 85°C**	98° – 185°F / 37° – 85°C**	98° – 160°F / 37° – 71°C**
<b>Min. Activation Rate</b>	0.4 gpm (1.5 lpm)	0.4 gpm (1.5 lpm)	0.4 gpm (1.5 lpm)	0.4 gpm (1.5 lpm)
<b>Flow Rate (70°/50° Temp. Rise)</b>	4.7 / 6.6 (17.8 / 29.2)	4.5 / 6.4 (17.03 / 24.2)	4.7 / 6.6 (17.8 / 29.2)	4.3 / 6.0 (16.3 / 22.7)
<b>Hot Water Flow Rate Range</b>	0.26 – 9.8 gpm (0.98 – 37.1 lpm)	0.26 – 9.8 gpm (0.98 – 37.1 lpm)	0.26 – 9.8 gpm (0.98 – 37.1 lpm)	0.26 – 7.5 gpm (0.98 – 28.4 lpm)
<b>Controller (Standard)</b>	MC-91-2US	MC-91-2US	MC-91-2US	MC-91-2US
<b>Controllers (Optional)</b>	MC-100-1, BC-100V-1, MC-195T-US, MCC-91-2, Control-R™ Wi-Fi Module			
<b>Ultra Low NOx</b>	No	Yes	Yes	Yes
<b>Warranty (Residential)*</b>	Limited 12-year on heat exchanger, 5-year on parts, 1-year on labor (5-year optional on labor)			
<b>Warranty (Commercial)*</b>	Limited 5-year on heat exchanger, 5-year on parts, 1-year on labor (2-year optional on labor)			
<b>Mobile Home Certified</b>	Yes	Yes	Yes	Yes
<b>Valves Shipped in Box</b>	Yes	Yes	Yes	Yes
<b>High Altitude Approved</b>	Up to 10,200 ft. (3,109 m)			
<b>Certifications</b>	AHRI and CSA			
<b>Venting Options</b>	Concentric	Concentric	N/A	Concentric
<b>Tankless Rack System™ (TRS/TRW) Compatible</b>	Not standard	Not standard	Not standard	Not standard
<b>Wi-Fi Ready</b>	Yes	Yes	Yes	Yes

\* For complete information and details regarding Rinnai's warranty, visit rinnai.us.

\*\* To achieve temperatures over 140°F (60°C), an MCC-91 commercial controller must be purchased separately.

\*\*\* For complete information on gas sizing for Rinnai Tankless Water Heaters, consult the Operation and Installation Manual.

HE+ Series High-efficiency (Non-condensing) and SE Series Super High-efficiency (Condensing) Tankless Water Heaters are 1/2-inch gas line compatible.



# MODEL CHART AND SPECIFICATIONS SUPER-HIGH-EFFICIENCY (CONDENSING) TANKLESS WATER HEATERS

## SE Series



RL75e	RUCS75i	RUS75e	RUCS65i	RUS65e
14 x 23 x 9 (355.6 x 584.2 x 228.6)	18.5 x 26 x 10 (469.9 x 660.4 x 254)	18.5 x 26 x 10 (469.9 x 660.4 x 254)	18.5 x 26 x 10 (469.9 x 660.4 x 254)	18.5 x 26 x 10 (469.9 x 660.4 x 254)
43.6 / 19.8	57.3 / 26	57.3 / 26	57.3 / 26	57.3 / 26
Outdoor	Indoor	Outdoor	Indoor	Outdoor
10,300/180,000	10,300/160,000	10,300/160,000	10,300/130,000	10,300/130,000
10,300/180,000	10,300/160,000	10,300/160,000	10,300/130,000	10,300/130,000
0.81	0.90	0.89	0.85	0.86
98° — 140°F / 37° — 60°C	120° — 140°F / 49° — 60°C	120° — 140°F / 49° — 60°C	120° — 140°F / 49° — 60°C	120° — 140°F / 49° — 60°C
98° — 160°F / 37° — 71°C**	Residential only	Residential only	Residential only	Residential only
0.4 gpm (1.5 lpm)	0.4 gpm (1.5 lpm)	0.4 gpm (1.5 lpm)	0.4 gpm (1.5 lpm)	0.4 gpm (1.5 lpm)
4.3 / 6.0 (16.3 / 22.7)	4.2 / 5.9 (15.9 / 22.3)	4.2 / 5.9 (15.9 / 22.3)	3.4 / 4.8 (12.9 / 18.1)	3.4 / 4.8 (12.9 / 18.1)
0.26 — 7.5 gpm (0.98 — 28.4 lpm)	0.26 — 7.5 gpm (0.98 — 28.4 lpm)	0.26 — 7.5 gpm (0.98 — 28.4 lpm)	0.26 — 6.5 gpm (0.98 — 24.6 lpm)	0.26 — 6.5 gpm (0.98 — 24.6 lpm)
MC-91-2US	status monitor	status monitor	status monitor	status monitor
	MC-91-2US	MC-91-2US	MC-91-2US	MC-91-2US
Yes	Yes	Yes	Yes	Yes
	Limited 12-year on heat exchanger, 5-year on parts, 1-year on labor			
	Residential only	Residential only	Residential only	Residential only
Yes	Yes	Yes	Yes	Yes
Yes	No	No	No	No
	Up to 5,400 ft. (1,646 m)			
	AHRI, CSA, ENERGY STAR®	AHRI, CSA, ENERGY STAR®	AHRI, CSA	AHRI, CSA
N/A	Concentric or PVC/CPVC/PP	N/A	Concentric or PVC/CPVC/PP	N/A
Not standard	No	No	No	No
Yes	No	Yes	Yes	Yes

# MODEL CHART AND SPECIFICATIONS

## SUPER-HIGH-EFFICIENCY (CONDENSING) TANKLESS WATER HEATERS

### SENSEI™ SE+ SERIES



FEATURING  
ThermaCirc360



FEATURING  
ThermaCirc360



FEATURING  
ThermaCirc360



FEATURING  
ThermaCirc360

Model	RUR199i	RUR199e	RUR160i	RUR160e
<b>Dimensions - w, h, d Inches (mm)</b>	18.5 x 26.4 x 11.5 (470 x 670 x 290)	18.5 x 26.4 x 11.5 (470 x 670 x 290)	18.5 x 26.4 x 11.5 (470 x 670 x 290)	18.5 x 26.4 x 11.5 (470 x 670 x 290)
<b>Weight (lbs / kg)</b>	73 / 33	73 / 33	71 / 32	71 / 32
<b>Installation Type</b>	Indoor	Outdoor	Indoor	Outdoor
<b>Min./Max. BTU</b>	15,000/199,000	15,000/199,000	15,000/160,000	15,000/160,000
<b>Uniform Energy Factor</b>	0.93	0.93	0.93	0.93
<b>Temp. Range Residential*</b>	98° F – 140° F / 37° C – 60° C	98° F – 140° F / 37° C – 60° C	98° F – 140° F / 37° C – 60° C	98° F – 140° F / 37° C – 60° C
<b>Temp. Range Commercial*†</b>	98° F – 140° F / 37° C – 60° C	98° F – 140° F / 37° C – 60° C	98° F – 140° F / 37° C – 60° C	98° F – 140° F / 37° C – 60° C
<b>Min. Activation Rate</b>	0.4 GPM (1.5 L/min)	0.4 GPM (1.5 L/min)	0.4 GPM (1.5 L/min)	0.4 GPM (1.5 L/min)
<b>Flow Rate (70°/50° Temp. Rise)</b>	5.4 / 7.6	5.4 / 7.6	4.3 / 6.1	4.3 / 6.1
<b>Hot Water Flow Rate Range</b>	0.26 - 9.8 GPM (1.0 - 37 L/min)	0.26 - 9.8 GPM (1.0 - 37 L/min)	0.26 - 8.0 GPM (1.0 - 30 L/min)	0.26 - 8.0 GPM (1.0 - 30 L/min)
<b>Controller (Standard)</b>	Integrated and Control-R™ Wi-Fi Module ships in the box			
<b>Controllers (Optional)</b>	MC-91-2US, required for recirculation: MC-195T-US			
<b>Warranty (Residential)**</b>	Limited 15-year on heat exchanger, 5-year on parts, 1-year on labor			
<b>Warranty (Commercial)**</b>	Limited 8-year on heat exchanger, 5-year on parts, 1-year on labor			
<b>Mobile Home Certified</b>	Yes	Yes	Yes	Yes
<b>Valves Shipped in Box</b>	Yes	Yes	Yes	Yes
<b>High Altitude Approved</b>	Up to 10,200 ft. (3,109 m)	Up to 10,200 ft. (3,109 m)	Up to 10,200 ft. (3,109 m)	Up to 10,200 ft. (3,109 m)
<b>Certifications</b>	AHRI, CSA, ENERGY STAR®	AHRI, CSA, ENERGY STAR®	AHRI, CSA, ENERGY STAR®	AHRI, CSA, ENERGY STAR®
<b>Venting Options</b>	Concentric or PVC/CPVC/PP	N/A	Concentric or PVC/CPVC/PP	N/A
<b>Ultra Low Nox</b>	Yes	Yes	Yes	Yes
<b>Tankless Rack System™ (TRS/TRW) Compatible</b>	Yes	Yes	Yes	Yes
<b>Wi-Fi Ready</b>	Yes	Yes	Yes	Yes
<b>Extended Service Plan Available†††</b>	Yes	Yes	Yes	Yes

\*\*To achieve temperatures over 140° F (60° C), consult the Operation and Installation Manual.

\*†To achieve temperatures up to 185° F (85° C), consult the Operation and Installation Manual.

\*\*For complete information and details regarding Rinnai's warranty, visit rinnai.us.

SENSEI SE+ Series Super High-efficiency (Condensing) Tankless Water Heaters are 1/2-inch gas line compatible.

††For complete information on gas sizing for Rinnai Tankless Water Heaters, consult the Operation and Installation Manual.



RU199i	RU199e	RU180i	RU180e
18.5 x 26.4 x 11.5 (470 x 670 x 290)	18.5 x 26.4 x 11.5 (470 x 670 x 290)	18.5 x 26.4 x 11.5 (470 x 670 x 290)	18.5 x 26.4 x 11.5 (470 x 670 x 290)
64 / 29	64 / 29	64 / 29	64 / 29
Indoor	Outdoor	Indoor	Outdoor
15,000/199,000	15,000/199,000	15,000/180,000	15,000/180,000
0.93	0.93	0.93	0.93
98° F – 140° F / 37° C – 60° C	98° F – 140° F / 37° C – 60° C	98° F – 140° F / 37° C – 60° C	98° F – 140° F / 37° C – 60° C
98° F – 185° F / 37° C – 85° C	98° F – 185° F / 37° C – 85° C	98° F – 185° F / 37° C – 85° C	98° F – 185° F / 37° C – 85° C
0.4 GPM (1.5 L/min)	0.4 GPM (1.5 L/min)	0.4 GPM (1.5 L/min)	0.4 GPM (1.5 L/min)
5.4 / 7.6	5.4 / 7.6	4.9 / 6.9	4.9 / 6.9
0.26 - 9.8 GPM (1.0 - 37 L/min)	0.26 - 9.8 GPM (1.0 - 37 L/min)	0.26 - 9.0 GPM (1.0 - 34 L/min)	0.26 - 9.0 GPM (1.0 - 34 L/min)
Integrated			
MC-195T-US, MC-91-2US, MCC-91-2US, Control-R™ Wi-Fi Module			
Limited 15-year on heat exchanger, 5-year on parts, 1-year on labor			
Limited 8-year on heat exchanger, 5-year on parts, 1-year on labor			
Yes	Yes	Yes	Yes
Yes	Yes	Yes	Yes
Up to 10,200 ft. (3,109 m)	Up to 10,200 ft. (3,109 m)	Up to 10,200 ft. (3,109 m)	Up to 10,200 ft. (3,109 m)
AHRI, CSA, ENERGY STAR®	AHRI, CSA, ENERGY STAR®	AHRI, CSA, ENERGY STAR®	AHRI, CSA, ENERGY STAR®
Concentric or PVC/CPVC/PP	N/A	Concentric or PVC/CPVC/PP	N/A
Yes	Yes	Yes	Yes
Yes	Yes	Yes	Yes
Yes	Yes	Yes	Yes
Yes	Yes	Yes	Yes

†††The Extended Service Plan provides 48 months of labor coverage for SENSEI model Tankless Water Heaters installed in a residential application upon product registration submitted within 90 days of the purchase of the unit. This coverage period begins after the initial labor warranty coverage has expired.

# MODEL CHART AND SPECIFICATIONS

## SUPER-HIGH-EFFICIENCY (CONDENSING) TANKLESS WATER HEATERS

### SENSEI™ SE+ SERIES



Model	RU160i	RU160e	RU130i	RU130e
<b>Dimensions - w, h, d Inches (mm)</b>	18.5 x 26.4 x 11.5 (470 x 670 x 290)	18.5 x 26.4 x 11.5 (470 x 670 x 290)	18.5 x 26.4 x 11.5 (470 x 670 x 290)	18.5 x 26.4 x 11.5 (470 x 670 x 290)
<b>Weight (lbs / kg)</b>	64 / 29	62 / 28	64 / 29	62 / 28
<b>Installation Type</b>	Indoor	Outdoor	Indoor	Outdoor
<b>Min./Max. BTU</b>	15,000/160,000	15,000/160,000	15,000/130,000	15,000/130,000
<b>Uniform Energy Factor</b>	0.93	0.93	0.91	0.92
<b>Temp. Range Residential*</b>	98° F – 140° F / 37° C – 60° C	98° F – 140° F / 37° C – 60° C	98° F – 140° F / 37° C – 60° C	98° F – 140° F / 37° C – 60° C
<b>Temp. Range Commercial**†</b>	98° F – 185° F / 37° C – 85° C	98° F – 185° F / 37° C – 85° C	98° F – 185° F / 37° C – 85° C	98° F – 185° F / 37° C – 85° C
<b>Min. Activation Rate</b>	0.4 GPM (1.5 L/min)	0.4 GPM (1.5 L/min)	0.4 GPM (1.5 L/min)	0.4 GPM (1.5 L/min)
<b>Flow Rate (70°/50° Temp. Rise)</b>	4.3 / 6.1	4.3 / 6.1	3.5 / 4.9	3.5 / 4.9
<b>Hot Water Flow Rate Range</b>	0.26 - 8.0 GPM (1.0 - 30 L/min)	0.26 - 8.0 GPM (1.0 - 30 L/min)	0.26 - 6.6 GPM (1.0 - 24 L/min)	0.26 - 6.6 GPM (1.0 - 24 L/min)
<b>Controller (Standard)</b>	Integrated			
<b>Controllers (Optional)</b>	MC-195T-US, MC-91-2US, MCC-91-2US, Control-R™ Wi-Fi Module			
<b>Warranty (Residential)**</b>	Limited 15-year on heat exchanger, 5-year on parts, 1-year on labor			
<b>Warranty (Commercial)**</b>	Consult the operation and installation manual			
<b>Mobile Home Certified</b>	Yes	Yes	Yes	Yes
<b>Valves Shipped in Box</b>	Yes	Yes	Yes	Yes
<b>High Altitude Approved</b>	Up to 10,200 ft. (3,109 m)	Up to 10,200 ft. (3,109 m)	Up to 10,200 ft. (3,109 m)	Up to 10,200 ft. (3,109 m)
<b>Certifications</b>	AHRI, CSA, ENERGY STAR®	AHRI, CSA, ENERGY STAR®	AHRI, CSA, ENERGY STAR®	AHRI, CSA, ENERGY STAR®
<b>Venting Options</b>	Concentric or PVC/CPVC/PP	N/A	Concentric or PVC/CPVC/PP	N/A
<b>Ultra Low Nox</b>	Yes	Yes	Yes	Yes
<b>Tankless Rack System™ (TRS/TRW) Compatible</b>	Yes	Yes	Yes	Yes
<b>Wi-Fi Ready</b>	Yes	Yes	Yes	Yes
<b>Extended Service Plan Available†††</b>	Yes	Yes	Yes	Yes

\*\*To achieve temperatures over 140° F (60° C), consult the Operation and Installation Manual.

†To achieve temperatures up to 185° F (85° C), consult the Operation and Installation Manual.

\*\*For complete information and details regarding Rinnai's warranty, visit rinnai.us.

SENSEI SE+ Series Super High-efficiency (Condensing) Tankless Water Heaters are 1/2-inch gas line compatible.

†† For complete information on gas sizing for Rinnai Tankless Water Heaters, consult the Operation and Installation Manual.

## COMMERCIAL SERIES



CU199i	CU199e	CU160i	CU160e
18.5 x 26.4 x 11.5 (470 x 670 x 290)	18.5 x 26.4 x 11.5 (470 x 670 x 290)	18.5 x 26.4 x 11.5 (470 x 670 x 290)	18.5 x 26.4 x 11.5 (470 x 670 x 290)
64 / 29	64 / 29	62 / 28	62 / 28
Indoor	Outdoor	Indoor	Outdoor
15,000/199,000	15,000/199,000	15,000/160,000	15,000/160,000
0.93 / 0.96; TE: 97%	0.93 / 0.96; TE: 97%	0.93 / 0.95; TE: 97%	0.93 / 0.95; TE: 97%
N/A	N/A	N/A	N/A
98° F – 185° F / 37° C – 85° C	98° F – 185° F / 37° C – 85° C	98° F – 185° F / 37° C – 85° C	98° F – 185° F / 37° C – 85° C
0.4 GPM (1.5 L/min)	0.4 GPM (1.5 L/min)	0.4 GPM (1.5 L/min)	0.4 GPM (1.5 L/min)
4.3 / 61	4.3 / 61	4.3 / 61	4.3 / 61
0.26 – 8.0 GPM (1.0 – 30 L/min)	0.26 – 8.0 GPM (1.0 – 30 L/min)	0.26 – 8.0 GPM (1.0 – 30 L/min)	0.26 – 8.0 GPM (1.0 – 30 L/min)
Integrated			
MC-91-2US			
Commercial only			
Heat Exchanger: 8 yrs or 12,000 operation hours, whichever occurs first, All other parts: 5 yrs, Reasonable Labor: 1 yr			
No	No	No	No
Yes	Yes	Yes	Yes
Up to 10,200 ft. (3,109 m)	Up to 10,200 ft. (3,109 m)	Up to 10,200 ft. (3,109 m)	Up to 10,200 ft. (3,109 m)
AHRI, CSA, ENERGY STAR®			
Concentric or PVC/CPVC/PP	N/A	Concentric or PVC/CPVC/PP	N/A
Yes	Yes	Yes	Yes
Yes	Yes	Yes	Yes
Yes	Yes	Yes	Yes
Yes	Yes	Yes	Yes

†††The Extended Service Plan provides 48 months of labor coverage for SENSEI model Tankless Water Heaters installed in a residential application upon product registration submitted within 90 days of the purchase of the unit. This coverage period begins after the initial labor warranty coverage has expired.

# HE+/HE Series

## Optimized Concentric Venting for Non-Condensing Models

Rinnai Tankless Water Heaters were the first to use a unique concentric venting system – featuring an inner tube for exhaust and an outer tube for fresh air from outdoors. The result is a direct-vent, sealed combustion system that offers optimum safety and performance.

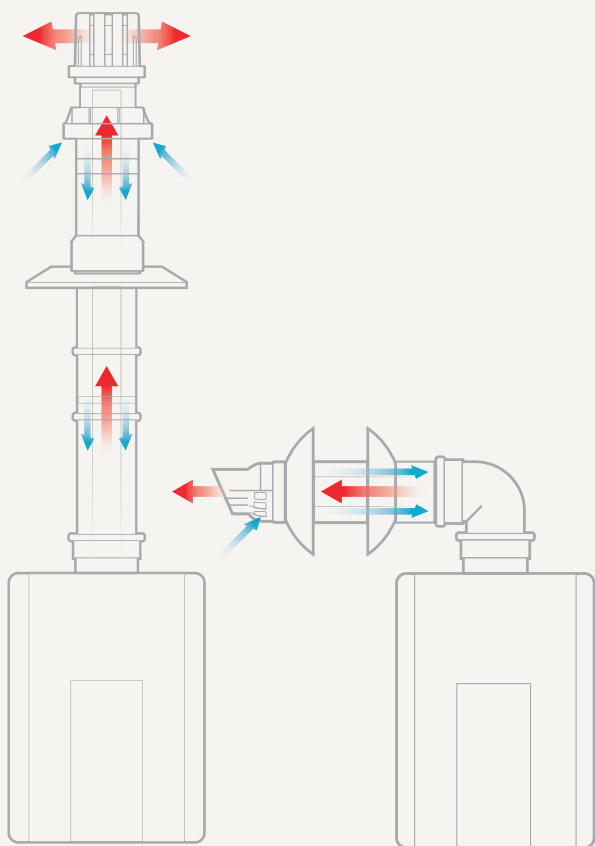

Venting available in vertical and horizontal configurations. Concentric structure allows hot exhaust to exit through interior tube, while fresh air enters through the outer layer.

# SE+/SE Series

## Multiple Venting Options for Condensing Models

The Rinnai SE and SE+ Series models offer concentric polypropylene or dual-pipe PVC/CPVC/PP venting options on the same model. The dual venting configuration on the top allows for maximum flexibility for installers and dealers — one concentric vent or two PVC/CPVC/PP pipes can be used for venting.

VENT TYPE	RUCS
Concentric PP	41 ft. (12.5 m)
Dual Pipe PP (Centrotherm)	41 ft. (12.5 m)

VENT TYPE	RUCS
3 in. Twin Pipe PVC/CPVC/PP (76.2 mm)	41 ft. (12.5 m)
4 in. Twin Pipe PVC/CPVC/PP (101.6 mm)	100 ft. (30.5 m)

\*Maximum equivalent vent lengths are specific to the fuel type of the RUC and RUR Tankless Water Heater. Use of elbows in installation will reduce the maximum vent length. It is imperative when performing equivalent vent length calculations that you refer to the Installation Manual and any applicable technical bulletins.

## INTAKE AND EXHAUST OPTIONS

### CONCENTRIC VENTING



### PVC/CPVC/PP CONFIGURATIONS



## Gas Line Sizes — 1/2 in. line not a problem

Rinnai Tankless Water Heaters are designed to always provide maximum performance and operating efficiency using either a 1/2" or 3/4" gas line, as long as sufficient gas flow is available.

SENSEI™ Condensing models automatically modulate gas input to maintain combustion if low gas pressure occurs.

# SENSEI™ SE+ Series

The Rinnai® SENSEI™ can be used for replacement applications, but new installs can use smaller, lighter, less expensive concentric venting.

- 14 possible vent configurations
- 9 compatible vent manufacturers\*

\*Includes PVC

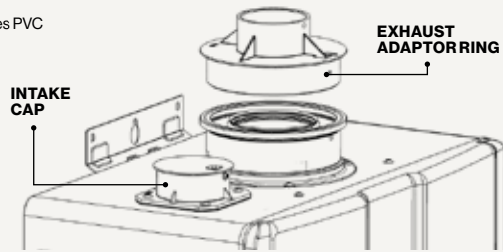

2 in. adaptor ring and cap let you use 3 in. / 5 in. concentric venting or 2 in. twin pipe venting

## 2 in. Venting Options

CONCENTRIC		
Diameter	Equivalent Length	Termination
3 in. / 5 in.	150' (46 m)	Vertical or Horizontal
2 in. / 4 in. (NEW)	65' (20 m)	Vertical or Horizontal

- Unit requires only a single penetration through the wall, reducing install time and costs
- Simple positive-fit components offer a secure connection
- Joint seals expand and contract with weather to prevent damage
- Assembly and adjustment are easy

TWIN PIPE AND ROOM AIR (PP, PVC, CPVC)		
Diameter	Equivalent Length	Termination
3 in.	150' (46 m)	Vertical or Horizontal
2 in. (NEW)	65' (20 m)	Vertical or Horizontal

## Example Vent Configurations

### CONCENTRIC

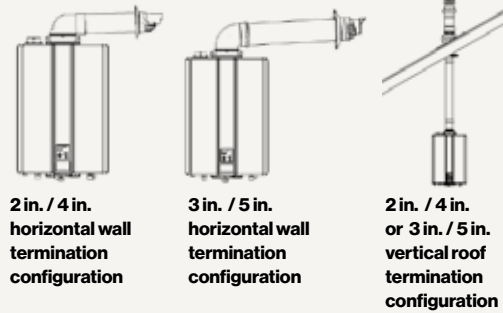

### TWIN PIPE

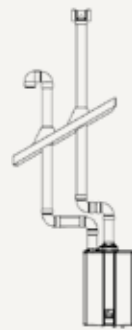

Vertical termination direct vent configuration

### ROOM AIR



Vertical termination room air configuration

### ELBOWS OR TEES

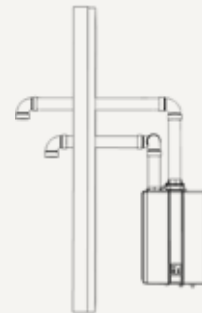

Elbow or tee side wall termination direct vent configuration



Elbow or tee side wall termination room air configuration

Consult NFPA 54 for safety requirements for the design and installation of fuel gas piping systems

# HE+ / HE VENTING COMPONENTS

## 3 IN. / 5 IN. VENTING COMPONENTS FOR HE+ / HE (NON-CONDENSING) TANKLESS WATER HEATERS

Part Number	Image	Description	Inner Exhaust Material	Outer Intake Material
184119	1	Roof Discharge Termination 38" (above roof)	Metal	Plastic
184127	1	Roof Discharge Termination 18 in. (above roof)	Metal	Metal
224046	2	Raised Horizontal Termination Kit (snorkel)	Metal	Plastic
223191	3	8.7 in. Universal Non-Condensing Horizontal Termination Kit	Metal	Plastic
223181	3	11.5 in. Universal Non-Condensing Horizontal Termination Kit	Metal	Plastic
223182	3	21 in. Universal Non-Condensing Horizontal Termination Kit	Metal	Plastic
223188	3	12 in. Universal Termination Kit	Metal	Metal
223183	4	11.5 in. Universal Non-Condensing Horizontal Termination	Metal	Plastic
223184	4	21 in. Universal Non-Condensing Horizontal Termination	Metal	Plastic
223187	5	21 in. Non-Condensing Horizontal Termination Diverter Kit termination for minimal clearance	Metal	Plastic
185342	-	Roof Termination Extension Kit	Metal	Plastic
224054	6	Telescoping Vent Length - 38 in.	Metal	Plastic
224063	7	90 Degree Elbow	Metal	Plastic
224255	7	90 Degree Elbow (metal)	Metal	Metal
224050	8	45 Degree Elbow (qty of 2)	Metal	Plastic
224250	8	45 Degree Elbow (metal)	Metal	metal
224051	9	10 in. Vent Pipe Extension	Metal	Plastic
224052	9	19.5 in. Vent Pipe Extension	Metal	Plastic
224053	9	39 in. Vent Pipe Extension	Metal	Plastic
224260	9	10 in. Vent Pipe Extension (metal)	Metal	Metal
224265	9	19.5 in. Vent Pipe Extension (metal)	Metal	Metal
224270	9	39 in. Vent Pipe Extension (metal)	Metal	Metal
184118-S	10	Roof Discharge Termination 18 in. (above roof)	Metal	Plastic

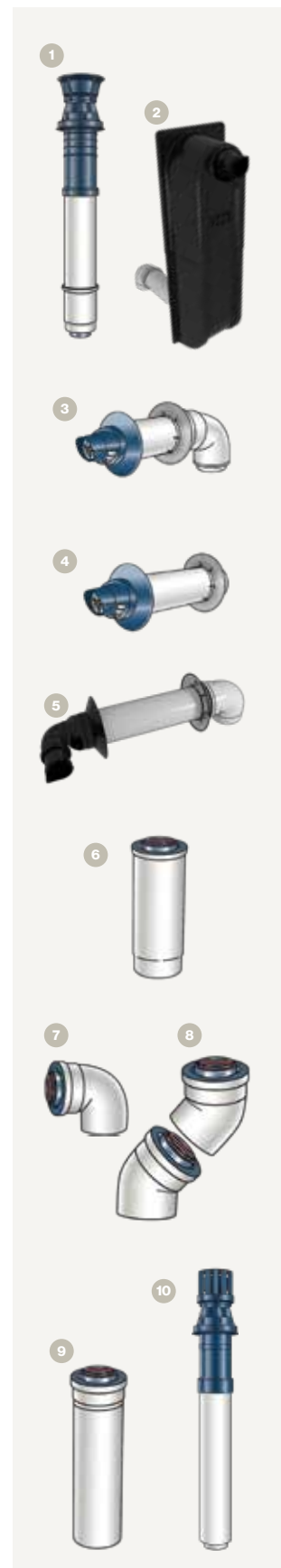



# SE+ / SE VENTING COMPONENTS

## 3 IN. / 5 IN. VENTING COMPONENTS FOR SE+ / SE (CONDENSING) TANKLESS WATER HEATERS

Part Number	Image	Description	Inner Exhaust Material	Outer Intake Material
224079PP	9	3 in. / 5 in. Condensing Vent Pipe Extension 19.5 in.	PP	Plastic
224080PP	9	3 in. / 5 in. Condensing Vent Pipe Extension 39 in.	PP	Plastic
224087PP	9	3 in. / 5 in. Condensing Vent Pipe Extension 10 in.	PP	Plastic
184162PP	11	3 in. / 5 in. Condensing Roof Discharge Termination 20 in. (above roof)	PP	Plastic
185344PP	12	3 in. / 5 in. Roof Termination Extension Kit	PP	Plastic
185346PP	13	3 in. / 5 in. Condensing Termination Extension	PP	Plastic
185347PP	13	Separation Kit	PP	Plastic
223174PP	14	3 in. / 5 in. Condensing Horizontal Term Kit 8.7 in.	PP	Plastic
223176PP	14	3 in. / 5 in. Condensing Horizontal Term Kit 12 in.	PP	Plastic
223177PP	14	3 in. / 5 in. Condensing Horizontal Term Kit 21 in.	PP	Plastic
223186PP	15	3 in. / 5 in. Condensing Horizontal Term Diverter Kit 19 in.	PP	Plastic
224047PP	116	3 in. / 5 in. Condensing Raised Horiz Term Kit (snorkel)	PP	Plastic
224077PP	17	3 in. / 5 in. Condensing 45 Degree Elbow (qty 2)	PP	Plastic
224078PP	18	3 in. / 5 in. Condensing 90 Degree Vent Pipe Elbow	PP	Plastic
187585PP	19	Twin Pipe Adapter For Use W PVC/CPVC (special order only)	PP	Plastic
224069	-	Condensate Collector	Metal	Metal
224049	-	3 in. / 5 in. Vent Support Bracket		
102000012	-	3 in. / 5 in. Horizontal Flashing Panel		
169043	-	3 in. / 5 in. Pipe Clamp Metal (SENSEI™ SE+ only)		

## 3 IN. PVC VENTING COMPONENTS

Part Number	Image	Description	Inner Exhaust Material	Outer Intake Material
196116PVC	-	3 in. Concentric PVC	PVC	PVC
196985PVC	-	3 in. Low Profile PVC	PVC	PVC

## 2 IN. / 4 IN. VENTING COMPONENTS FOR SE+ / SE (CONDENSING) TANKLESS WATER HEATERS

Part Number	Image	Description	Inner Exhaust Material	Outer Intake Material
222716	-	2 in. Pipe Clamp Plastic (qty 10) (SENSEI™ SE+ only)	Plastic	Plastic
224055	-	2 in. / 4 in. Thimble (SENSEI™ SE+ Only)	Metal	Metal
710265	-	2 in. / 4 in. Rubber Wall Plate White (SENSEI™ SE+ only)		
710192	-	2 in. / 4 in. Rubber Wall Plate Black (SENSEI™ SE+ only)		
169013	-	2 in. / 4 in. Pipe Clamp Metal (SENSEI™ SE+ only)		
224056	-	2 in. / 4 in. Vent Support Bracket (SENSEI™ SE+ only)		

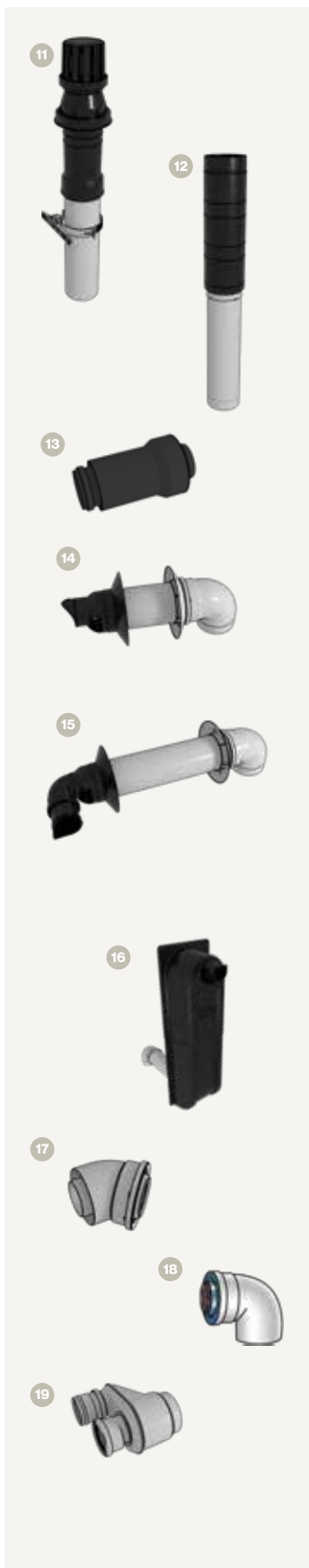

# SENSEI™ SE+ / SE VENTING COMPONENTS

## 2 IN. VENTING FOR ROOM AIR AND TWIN PIPE

Part Number	Image	Description	Inner Exhaust Material	Outer Intake Material
222715NPP	1	2 in. Condensing Fixing Clip Metal (qty 10)	PP	Plastic
184470NPP	2	2 in. Condensing Flex Termination Kit	PP	Plastic
222720NPP	3	2 in. Flex Connector	PP	Plastic
222721NPP	4	2 in. Flex Roll (41.5 ft.)	PP	Plastic
223085NPP	5	2 in. Condensing Wall Terminal Twin Pipe	PP	Plastic
187595NPP	6	2 in. x 2/4 Condensing Twin Pipe Adaptor	PP	Plastic
222710NPP	7	2 in. Condensing 45 Degree Elbow (20/ box)	PP	Plastic
222711NPP	8	2 in. Condensing 90 Degree Elbow (20/ box)	PP	Plastic
222712NPP	9	2 in. Condensing Vent Pipe Extension 39 in. (4/ box)	PP	Plastic
222714NPP	9	2 in. Condensing Vent Pipe Extension 79 in. (4/ box)	PP	Plastic

## 2 IN. /4 IN. INSTALLATION VENTING COMPONENTS FOR SE+ TANKLESS WATER HEATERS AND M-SERIES BOILERS

Part Number	Image	Description	Inner Exhaust Material	Outer Intake Material
710202NPP	10	2 in. /4 in. Condensing 90 Degree Diverter Nose	PP	Plastic
710215NPP	11	2 in. /4 in. Condensing 45 Degree Diverter Nose	PP	Plastic
229011NPP	12	2 in. /4 in. Condensing Horizontal Termination Kit 8.7 in.	PP	Plastic
229012NPP	12	2 in. /4 in. Condensing Horizontal Termination Kit 12 in.	PP	Plastic
229013NPP	12	2 in. /4 in. Condensing Horizontal Termination Kit 21 in.	PP	Plastic
229016NPP	13	2 in. /4 in. Condensing 21 in. Wall Term w/2 wall plates	PP	Plastic
224356NPP	-	2 in. /4 in. Condensing Roof Discharge Term 20 in. (above roof)	PP	Plastic
229205NPP	14	2 in. /4 in. Condensing 45 Degree Elbow (qty 2)	PP	Plastic
229230NPP	15	2 in. /4 in. Condensing 90 Degree Elbow (qty 2)	PP	Plastic
229253NPP	16	2 in. /4 in. Condensing Horizontal Starter Adapter	PP	Plastic
229308NPP	17	2 in. /4 in. Condensing Vent Pipe Extension 10 in.	PP	Plastic
229309NPP	17	2 in. /4 in. Condensing Vent Pipe Extension 19.5 in.	PP	Plastic
229310NPP	17	2 in. /4 in. Condensing Vent Pipe Extension 39 in.	PP	Plastic
227412NPP	18	2 in. /4 in. Condensing Vertical Starter Adapter	PP	Plastic
185348NPP	19	2 in. /4 in. Condensing Roof Term Extension Kit	PP	Plastic

## IPEX VENTING COMPONENTS FOR SENSEI SE+ AND M-SERIES BOILERS

Part Number	Image	Description	Inner Exhaust Material	Outer Intake Material
196005PVC	-	IPEX 2 in. Concentric Termination 2 x 16	PVC	PVC
196105PVC	-	IPEX 2 in. Concentric Termination 2 x 28	PVC	PVC
196125PVC	-	IPEX 2 in. Concentric Termination 2 x 40	PVC	PVC
192984PVC	-	IPEX PVC Low Profile Termination 2 in.	PVC	PVC



# ACCESSORIES FOR TANKLESS WATER HEATERS

## INSTALLATION ACCESSORIES

Part Number	Image	Description	Series
222053	1	Condensate Trap, version 2	HE / HE+
224245	2	Condensate Collector	HE / HE+

## CONTROLLERS

Part Number	Image	Description	Color
MC-91-2S	3	Temperature Controller Silver	Silver
MC-91-2W	4	Temperature Controller White	White
MCC-91-2W	4	Temperature Controller Commercial White	White
BC-100V-1S*	5	Bath Controller Silver	Silver
BC-100V-1W*	5	Bath Controller White	White
MC-195T-US*	6	Recirculation Timer Controller	Silver
MC-100V-1S*	7	Controller Silver	Silver
MC-100V-1W*	7	Controller White	White
RWM101	8	Control-R™ Wi-Fi Module	Black

## DEMAND RECIRCULATION COMPONENTS

Part Number	Image	Description
RWM101	8	Control-R™ Wi-Fi Module
RWMPB01*	9	Control-R™ Wi-Fi Push Button
RWMMS01	10	Control-R™ Wi-Fi Motion Sensor

## DEMAND RECIRCULATION KITS FOR SE+ SERIES FEATURING THERMACIRC360™

Part Number	Image	Description
RWMKT01		Control-R™ Wireless Demand Recirculation Kit
	8	Control-R™ Module (RWM101) Attaches easily to the Rinnai Tankless Water Heater by a two-wire interface
	9	Wireless Push Button Device* (RWMPB01) Mounted near the point of use, like a kitchen faucet or bathroom sink, and operates the recirculation system
RWMKT03		Control-R™ Wireless Demand Recirculation Kit (1PB/ 1TS)
	8	Control-R™ Module (RWM101) Attaches easily to the Rinnai Tankless Water Heater by a two-wire interface
	9	Wireless Push Button Device* (RWMPB01) Mounted near the point of use, like a kitchen faucet or bathroom sink, and operates the recirculation system
	12	Wireless Temperature Sensor* (RWMTS01) Turns off the recirculation and is available for purchase if required by local building codes

## DEMAND RECIRCULATION KITS FOR HE+ AND SE+ SERIES

Part Number	Image	Description
RWMKT01P		Control-R™ Wireless Demand Recirculation (1PB w/ Pump Kit)
	8	Control-R™ Module (RWM101) Attaches easily to the Rinnai Tankless Water Heater by a two-wire interface
	9	Wireless Push Button Device* (RWMPB01) Mounted near the point of use, like a kitchen faucet or bathroom sink, and operates the recirculation system
	11	External Pump Grundfos® Pump for Rinnai Circ-Logic Enabled Tankless Water Heaters
RWMKT03P		Control-R™ Wireless Demand Recirculation 1PB / 1TS Pump Kit
	8	Control-R™ Module (RWM101) Attaches easily to the Rinnai Tankless Water Heater by a two-wire interface
	9	Wireless Push Button Device* (RWMPB01) Mounted near the point of use, like a kitchen faucet or bathroom sink, and operates the recirculation system
	11	External Pump Grundfos® Pump for Rinnai Circ-Logic Enabled Tankless Water Heaters
	12	Wireless Temperature Sensor* (RWMTS01) Turns off the recirculation and is available for purchase if required by local building codes

\*Additional push buttons and motion sensors can be purchased separately to customize a recirculation system to the home.



# ACCESSORIES FOR TANKLESS WATER HEATERS

## HIGH-EFFICIENCY & SUPER-HIGH-EFFICIENCY (NON-CONDENSING & CONDENSING TECHNOLOGY)

Part Number	Image	Description	
146141	13	Roof Flashing Assembly (flat roof)	
189950	14	Shingle Roof Flashing (1/12 to 6/12 pitch; plastic)	
189951	14	Shingle Roof Flashing (6/12 to 12/12 pitch; plastic)	
189952	14	Shingle Roof Flashing (8/12 to 16/12 pitch; plastic)	
50171949	15	Tile/Shingle Roof Flashing (1/12 to 6/12 pitch; plastic)	
50171961	15	Tile/Shingle Roof Flashing (6/12 to 12/12 pitch; plastic)	
50171954	15	Tile/Shingle Roof Flashing (8/12 to 16/12 pitch; plastic)	
242141	16	Flashing for Metal Roof	
710342	17	Rubber Wall Plate (white)	
710602	17	Rubber Wall Plate (black)	
224045	18	Thimble (1 piece per box)	
169044	19	Pipe Clamp	
224097	20	Metal Pass Through Plate	
224042	21	Universal Bug Guard	
804000074	22	Condensate Neutralizer Kit (SE)	SE
103000038		ScaleCutter System 3/4 in. Feed	SE, SE+
103000039	23	ScaleCutter Refill Cartridge	SE, SE+
REU-PVA-4	-	Pressure Activated Valve	Legacy SE+, RUC
104000059	-	Freeze Protection drain down kit; Solenoid Valve Kit for Outdoor Units in Cold Regions	SE, HE+, HE
MIVK-T-LW	-	Isolation Valve Kit	Excludes SENSEI™
809000114	24	Refill, Condensate Neutralizer	All
104000285	-	Freeze Protection, Drain Down Kit (SENSEI™)	SENSEI™
107000284	-	Isolation Valve Kit (SENSEI™)	SENSEI™

Suitable for use with plastic and metal components

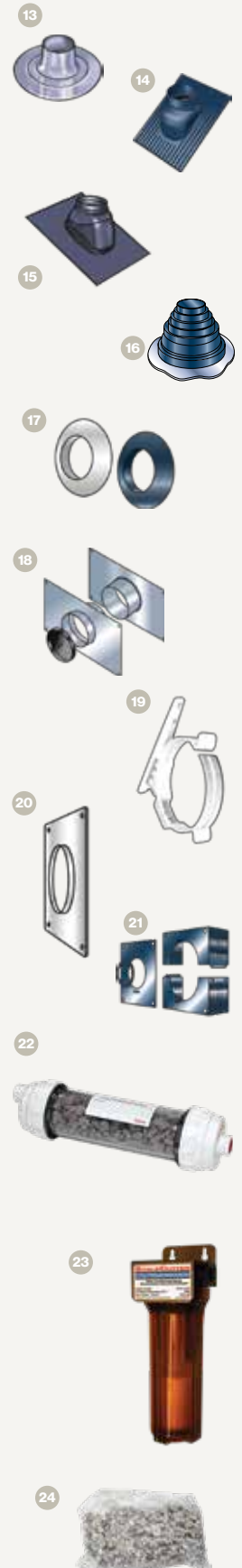

## OTHER ACCESSORIES - CONNECTION CABLES

Part Number	Image	Description	Series
REU-MSB-C1	25	Cable Connect VA, VB, Condensing, Excluding V53 / R63	HE (VA, VB excluding V53, R63, SE+, SE)
REU-MSB-C2	26	Cable For Connecting MSB-M Control Units	SE, HE, + HE
REU-MSB-M	27	Multi Unit Control	SE, HE, + HE
REU-EZC-1-US	-	EZConnect™ Cable	ALL
REU-EZC-2	-	EZconnect™	ALL
REU-OPU3	-	BMS/Air Handler (Replaces 103000037)	SE+, SE, HE+, HE
103000037	-	Domestic Priority Switch for Hydronic Air Handler/Maintenance Indication Switch	SE, HE+, HE
REU-CSA-C1	28	Cascade Harness 3m	Commercial
REU-CSA-C2	28	Cascade Harness 8m	Commercial

# ACCESSORIES FOR TANKLESS WATER HEATERS

## OTHER ACCESSORIES - PIPE ENCLOSURES

Part Number	Image	Description	Series
PC-20-W	-	Pipe Cover Enclosure for V53e / RV53e	HE
PCD03-SM2	29	Pipe Cover Enclosure (HE+)	HE+
PCD03-SM2-BP	30	Bottom Plate for PCD03-SM2 pipe cover and PDC03-EWV	HE+
PCD01-EWV		PIPE COVER FOR V53De (euro white)	HE (V53De)
PCD03-EWV	-	Pipe Cover Enclosure for the V94 / V65 / V75 Units	HE
PCD07-SM		Pipe Cover Condensing Product	SENSEI™ SE+
PCD07-SM-BP	-	Pipe Cover Bottom Panel - Condensing	SENSEI™ SE+
PCD07-EW	-	Pipe Cover RUCS75 / RUCS65	SE
PCD07-EW-BP	-	Bottom Plate RUCS75 / RUCS65	SE
PCD07-IB	31	Pipe Enclosure For Commercial (indigo black)	SENSEI™ SE+ Commercial
PCD07-IB-BP	32	Bottom Plate Commercial (indigo black)	SENSEI™ SE+ Commercial

## OTHER ACCESSORIES - RECESS BOXES

Part Number	Image	Description	Series
109000724	-	Recess Box Spare Door (SENSEI SE+)	SE+ (SENSEI™)
109000284	-	Recess Box Replacement Door KB / KBP / C199	SE / SE+
109000535	-	Recess Box Replacement Door KCM	SE
109000283	-	RGB-25U/MSAL Replacement Door Kit (for fitting VC units into old RGB-25U/MSAL boxes)	HE+
109000824	-	Replacement Door Kit for V53De	HE (V53De)
RGB-20-U	-	Recess Box for Non-Condensing	HE (RV53e / V53e)
RGB-25U-C	-	Universal Recess Box for Non-Condensing	HE / HE+ Series (excludes V53e Models)
RGB-CTWH-2	33	Recess Box for Current Condensing Models	SE (KB and KBP Generation)
RGB-CTWH-3	-	Recess Box for Condensing SE Series	SE (RUCS and RUS Models)
RGB-CTWH-4	-	Recess Box for Condensing (SENSEI™ SE+, SE Series, Commercial)	SENSEI SE+
RGB-25U-MSAL-C	-	Universal Moisture Seal Recess Box	HE, HE+ Series (excludes V53e Models)

## OTHER ACCESSORIES - SENSEI™ CONVERSION KITS (LP TO NG OR NG TO LP)

Part Number	Image	Description	Models
103000076	-	Conversion Kit	RU199i, RUR199i, CU199i
103000077	-	Conversion Kit	RU199e, RUR199e, CU199e
103000078	-	Conversion Kit	RU180i
103000079	-	Conversion Kit	RU180e
103000080	-	Conversion Kit	RU160i, RUR160i, CU160i
103000081	-	Conversion Kit	RU160e, RUR160e, CU160e
103000082	-	Conversion Kit	RU130i
103000083	-	Conversion Kit	RU130e



# FLOW CHART AND HERS DATA

## RINNAI TANKLESS WATER HEATERS HOT WATER FLOW CURVE

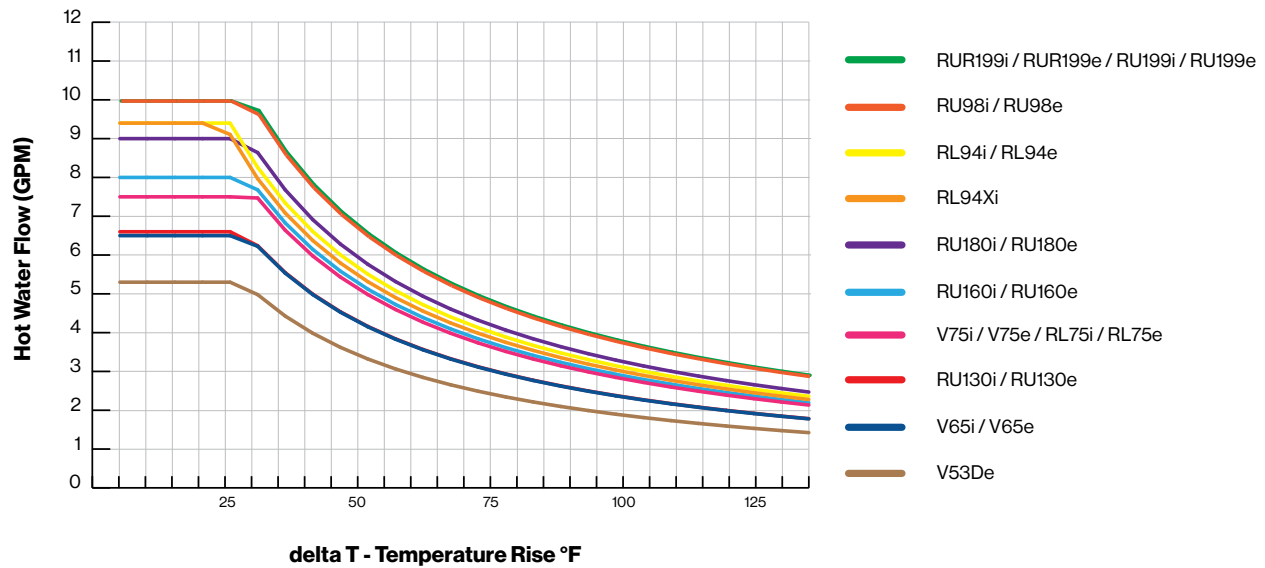

Tankless water heater output is based on Delta T, which is the difference between the incoming water temperature and the requested output temperature. This chart is used along with other factors to help size the Rinnai tankless model for your application.

## HERS SCORES IMPROVE WITH RINNAI TANKLESS WATER HEATERS

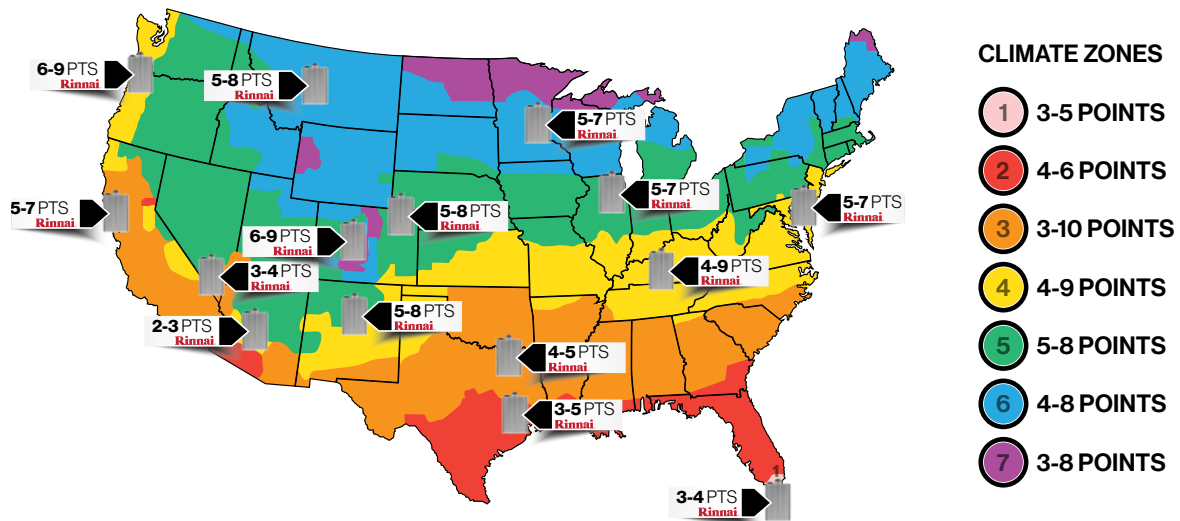

The Home Energy Rating System (HERS) Index is the industry standard by which a home's energy efficiency is measured. A lower HERS Index Score means a more energy-efficient home, which means lower energy costs.

Data analysis conducted by independent third party HERS rater compares traditional electric and gas residential storage tank water heaters to Rinnai's Condensing and Non-Condensing Tankless Water Heaters. Consult and validate your specific application with a local HERS rater.

For more information specific to your zone or city, visit [hersindex.com](http://hersindex.com).

# Endless

## Quality and Support

## 100 Years of Smart Comfort

**For nearly a century**, Rinnai has been fiercely committed to delivering a smarter kind of comfort. With headquarters in Japan and a network of 20 subsidiaries and 86 sales offices in 13 countries, this commitment has made us one of the world's largest gas appliance manufacturers. Our value-added products continue to stay in step with the demands of a changing world.

## The Highest Standards of Quality

Rinnai employs more than 600 research and development engineers, all focused on uncompromising quality in design and manufacturing. Advanced automation and precision assembly processes have made our manufacturing facilities an industry model for efficiency. Throughout the world, our standards for quality remain unsurpassed.

- Every product undergoes live testing before shipping
- One of the few tankless water heater manufacturers with its own state-of-the-art Canadian Standards Association Certified Testing Laboratory, including CSA accredited lab technicians
- All products have been approved by the CSA and adhere to the strict standards of the American National Standards Institute (ANSI)



## A World of Support Behind You

Beyond manufacturing the highest-quality products, our people stand behind all that we make—before, during and long after installation.

- **24/7/365 technical support** for professionals
- **National network of independent dealers**
- **On-staff engineers** who can assist with choosing the right products and sizes



Water Heating Solutions



Home Heating Solutions



Commercial Water Heating Solutions

## Creating a Healthier Way of Living

Learn more about Rinnai high-performance Tankless Water Heaters, Hybrid Water Heating Systems, Boilers, Vent-Free Fan Convectors and EnergySaver® Direct Vent Wall Furnaces at:

**[rinnai.us](http://rinnai.us) | [rinnai.ca](http://rinnai.ca)**

**Rinnai**®

**Rinnai America Corporation**

103 International Drive | Peachtree City, GA 30269  
1-800-621-9419 | [rinnai.us](http://rinnai.us) | [rinnai.ca](http://rinnai.ca)

PROUD SPONSOR



FOLDS of HONOR