

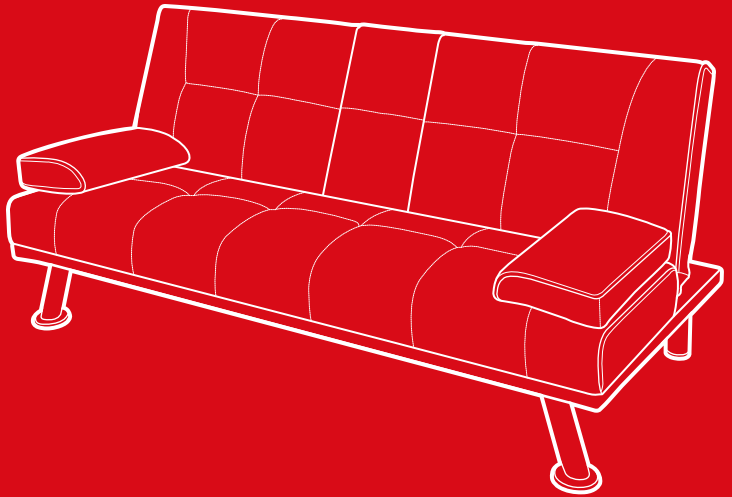

bestchoiceproducts



INSTRUCTION MANUAL

Converting Futon Sofa
with Cup Holders



Hardware & parts
are located in
the compartment
underneath the sofa.

Make sure to
remove all items
before assembly.

bestchoiceproducts.com

NOTICE

Please retain these instructions for future reference.

- Do not stand on or jump on any part of this item.
- Firmly secure all bolts and knobs before use.
- Reconfirm that all bolts and knobs are secure every 90 days.
- Do not use or store this item in the proximity of open flame or flammable/combustible chemicals.
- If any parts are missing, broken, damaged, or worn, stop using this product until repairs are made and/or factory replacement parts are installed.
- Do not use this item in a way inconsistent with the manufacturer's instructions as this could void the product warranty.
- This futon has a weight capacity of 500 lbs. Please do not exceed that amount of weight on the chair.

TOOLS REQUIRED



500 LBS
CAPACITY



1 PERSON
ASSEMBLY



APPROXIMATELY
15 MIN.
ASSEMBLY

HARDWARE

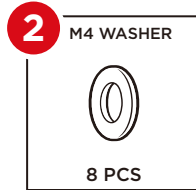
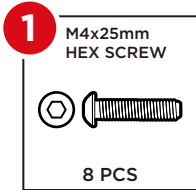

PARTS

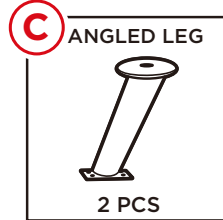
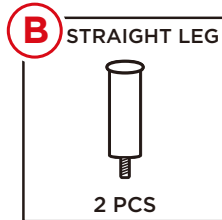
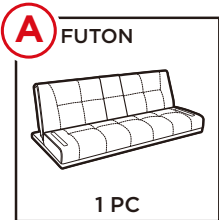

CALIFORNIA PROPOSITION 65

WARNING: This product can expose you to Diisononyl phthalate (DINP), which is known to the State of California to cause cancer. For more information go to www.P65Warnings.ca.gov

PRODUCT ASSEMBLY

1

Remove legs and hardware from the compartment underneath the part A futon.

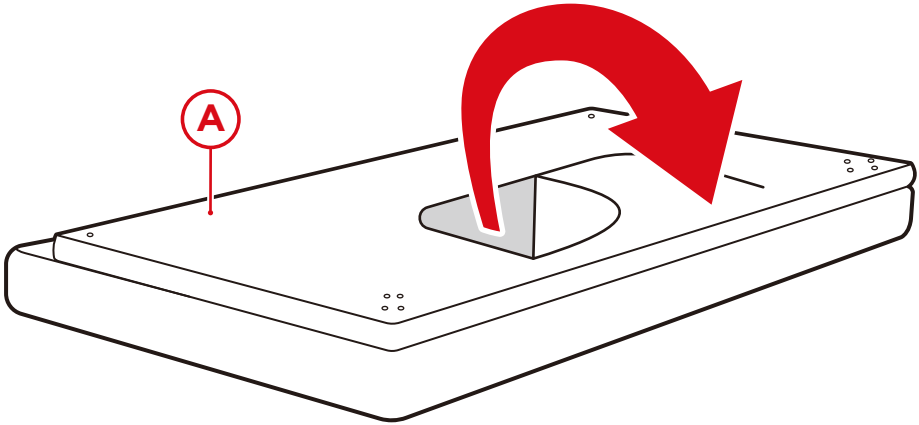

2

Screw in the two part B straight legs.

Attach two part C angled legs with eight part 1 screws and eight part 2 washers, four screws/washers per leg.

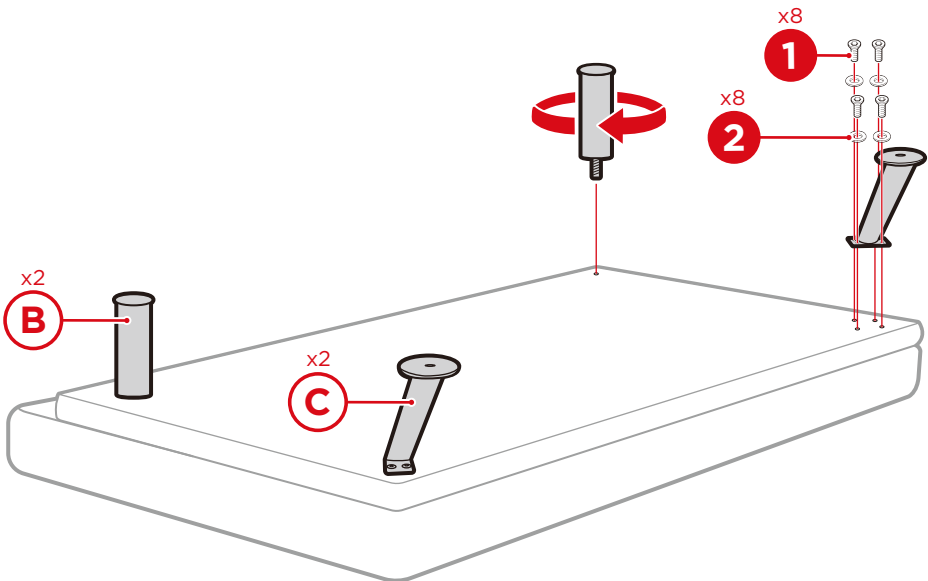

PRODUCT ASSEMBLY

3

Place two part D armrests.

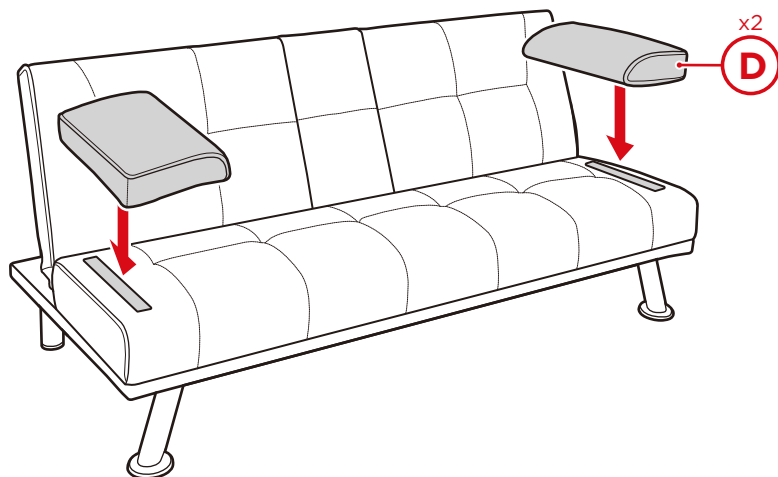

CUPHOLDERS

Unfold the center armrest to access the two cupholders.

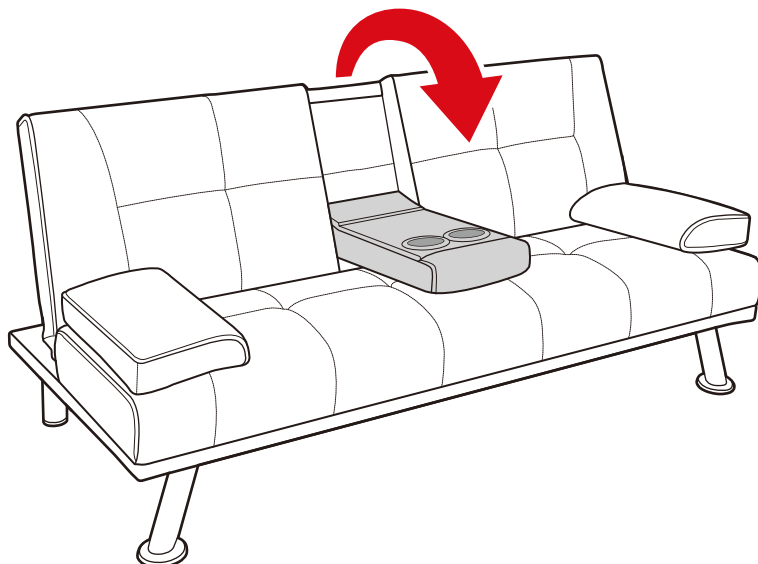

ADJUSTING THE FUTON

The futon locks at three positions: upright, leaning back, and flat.

To adjust the position, bring the backrest all the way forward, then lean it back to your desired position.

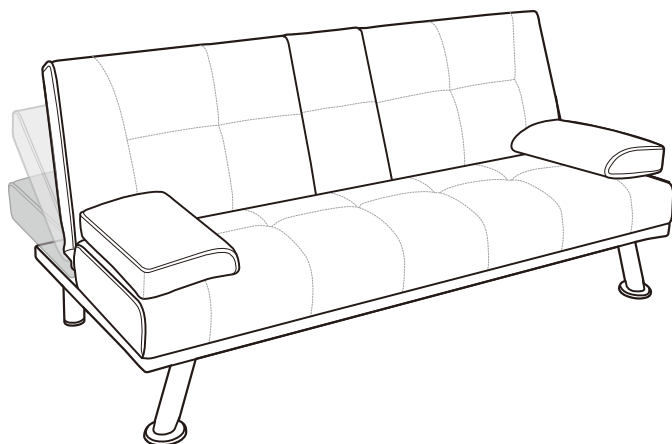
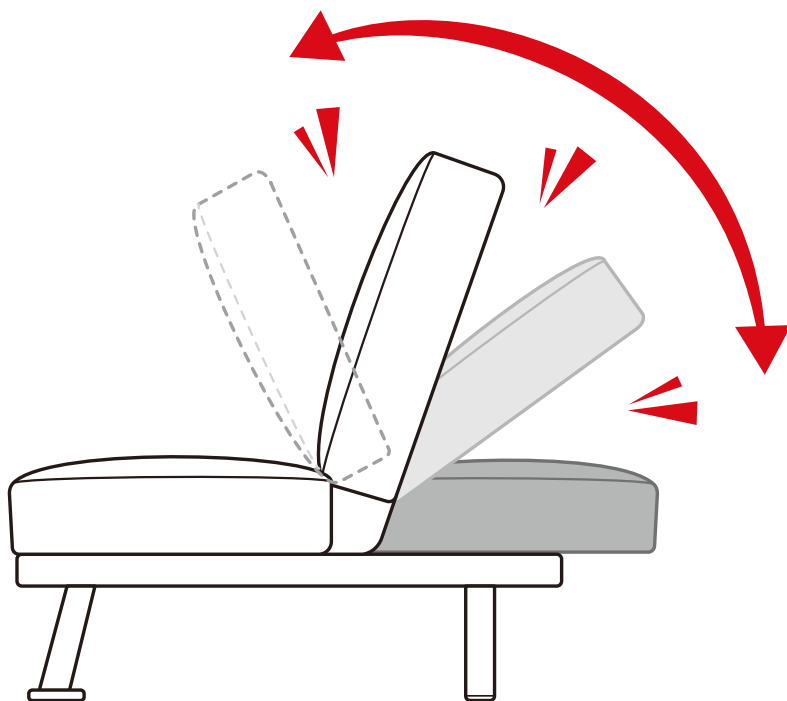

Earn points while you shop. Join today!

bestchoiceproducts
rewards

Join | Earn | Redeem

Give your friends 15% off their first order! For each successful referral you'll receive 100 points.

bestchoiceproducts.com



HELP CENTER



Question about your product? We're here to help. Visit us at:

help.bestchoiceproducts.com



Chat Support



Product Inquiry



Orders FAQ



Product Assembly



Returns & Refunds

PRODUCT WARRANTY INFORMATION

All items can be returned for any reason within 60 days of the receipt and will receive a full refund as long as the item is returned in its original product packaging and all accessories from its original shipment are included. All returned items will receive a full refund back to the original payment method. All returned items will not be charged a re-stocking fee.

All returned items require an RA (Return Authorization) number, which can only be provided by a Best Choice Products Customer Service Representative when the return request is submitted. Items received without an RA may not be accepted or may increase your return processing time. Once an item has been received by Best Choice Products, refunds or replacements will be processed within 5 business days.

All returns must be shipped back to the Best Choice Products Return Center at the customer's expense. If the reason for return is a result of an error by Best Choice Products then Best Choice Products will provide a pre-paid shipping label via email. Boxes for return shipping will not be provided by Best Choice Products, and is the customer's responsibility to either use the original shipping boxes or purchase new boxes.

Pictures may be required for some returns to ensure an item is not damaged prior to its return. Items returned are not considered undamaged until they are received by Best Choice Products and verified as such. All damages to items are the customer's responsibility until the item has been received by and acknowledge by Best Choice Products as undamaged.



WARNING

Manufacturer and seller expressly disclaim any and all liability for personal injury, property damage or loss, whether direct, indirect, or incidental, resulting from the incorrect attachment, improper use, inadequate maintenance, or neglect of this product.