

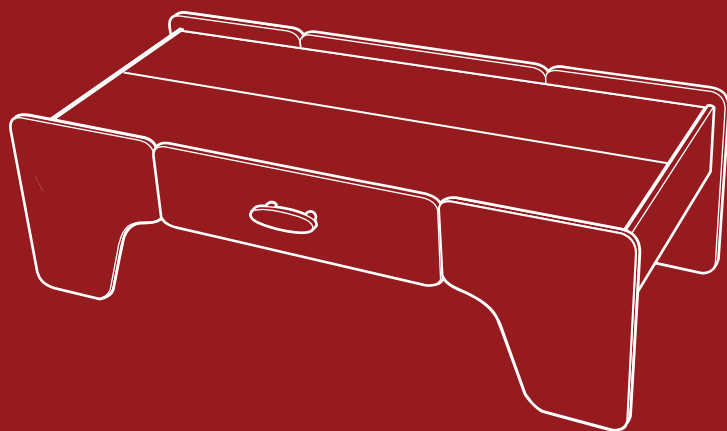

BEST CHOICE
PRODUCTS



INSTRUCTION MANUAL

Train Table



**BEST CHOICE
PRODUCTS**

As shoppers, we're always trying to find the perfect balance between quality & value. At BCP, we believe we've achieved that. Our diverse catalog of everyday essentials is tailored especially to our customers & guaranteed to hit that sweet spot of high quality & low price.

— Always. —

⚠ WARNING
ADULT ASSEMBLY REQUIRED

⚠ WARNING
CHOKING HAZARD - Small parts.
Not for children under 3 years old.

! NOTICE Please retain these instructions for future reference.

- This product requires adult assembly and supervision when in use.
- This product is intended for indoor use only.
- Do not stand on or use any part of this item as a step ladder.
- Firmly secure all bolts, screws and knobs before use.
- Reconfirm that all bolts, screws, and knobs are secure every 90 days.
- Do not use or store this item in the proximity of open flame or flammable/combustible chemicals.
- If any parts are missing, broken, damaged, or worn, stop using this item until repairs are made and/or factory replacement parts are installed.
- Do not use this item in a way inconsistent with the manufacturer's instructions as this could void the product warranty.
- This product contains small parts. May result in choking hazard for children under 3 years.
- To wipe down item, use a damp cloth. Then, wipe it down once more with a dry cloth.
- This product is intended for residential use only.

TOOLS REQUIRED



PHILLIPS
SCREWDRIVER



ALLEN WRENCH
(OPTIONAL)

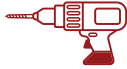

ELECTRIC DRILL
(OPTIONAL)



3 YEARS
OLD AND UP



1 PERSON
ASSEMBLY



UP TO 60 MIN.
ASSEMBLY

HARDWARE

A CROSS DOWEL
BOLT



16 PCS

B CROSS DOWEL
NUT



8 PCS

C SCREW



12 PCS

PARTS

1 SIDE PANEL

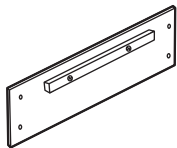

2 PCS

2 FRONT PANEL

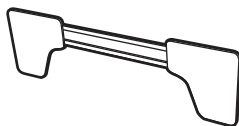

1 PC

3 DRAWER SUPPORT

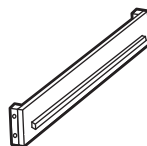

2 PCS

4 BACK PANEL

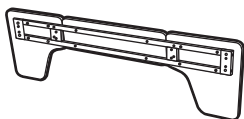

1 PC

5 TOP PANEL



2 PCS

6 DRAWER HANDLE



1 PC

7 DRAWER FRONT

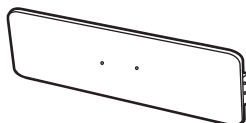

1 PC

8 RIGHT DRAWER PANEL

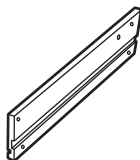

1 PC

9 LEFT DRAWER PANEL

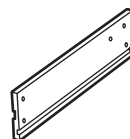

1 PC

10 DRAWER BOTTOM



1 PC

11 DRAWER BACK



1 PC

12 DRAWER STOPPERS



2 PCS

TRAIN TABLE ASSEMBLY

1

Attach the part 6 drawer handle to the part 7 drawer front with two part C screws.

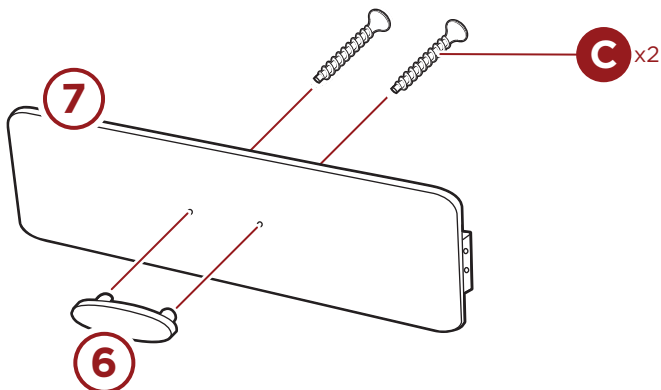

2

Place the part 10 drawer bottom into the slots of the parts 7, 8, 9, and 11 drawer panels and secure the panels with eight part C screws.

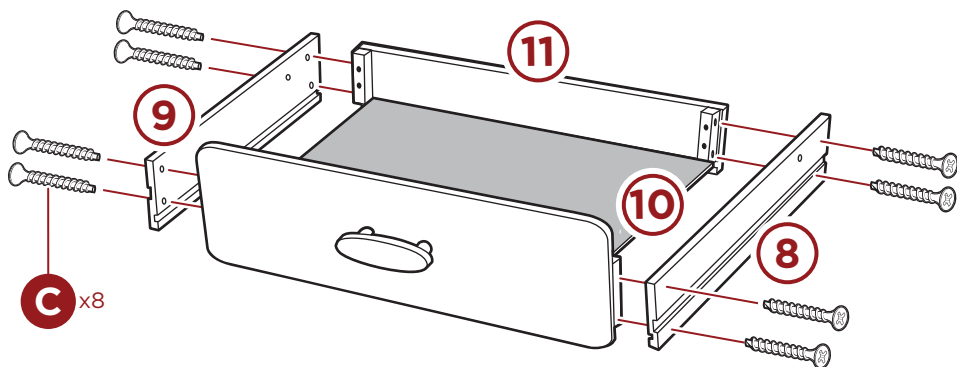

TRAIN TABLE ASSEMBLY

3

Insert four part B nuts into the part 4 back panel and attach two part 1 side panels with four part A bolts.

Insert four part B nuts into the part 2 front panel and attach the part 1 side panels with four more part A bolts.

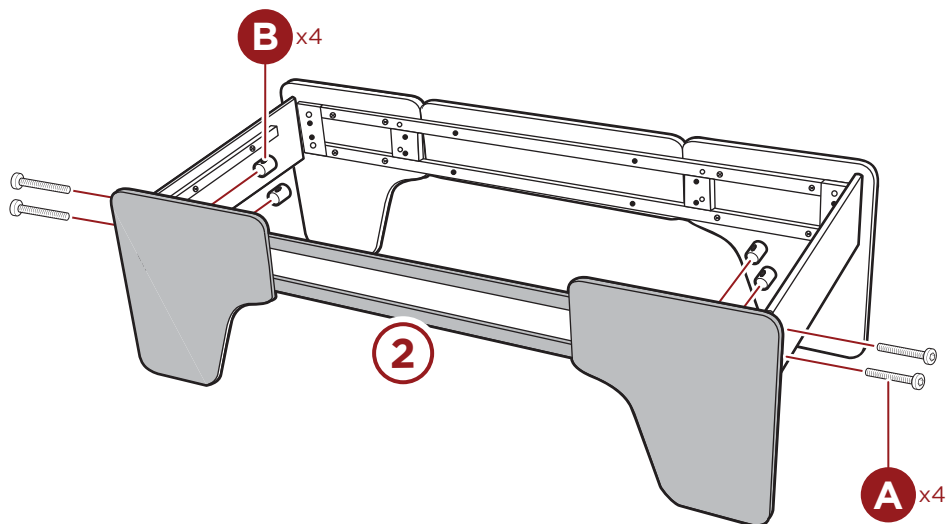
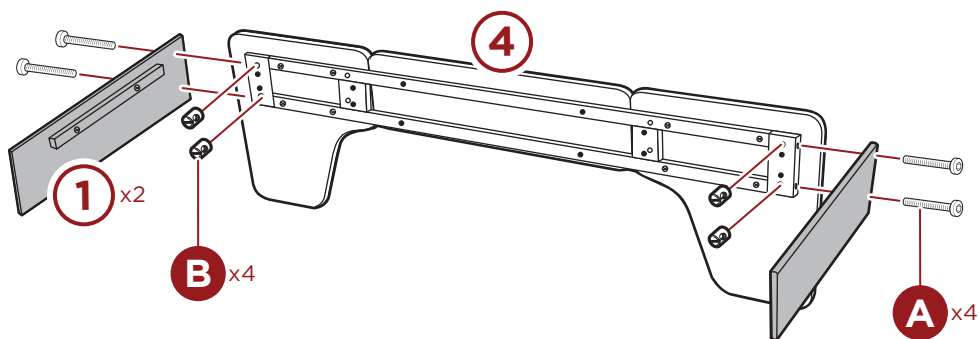

TRAIN TABLE ASSEMBLY

4

Locate and attach two part 3 drawer supports to the left and right center of the part 2 & 4 front and back panels (see step 3) with eight part A bolts.

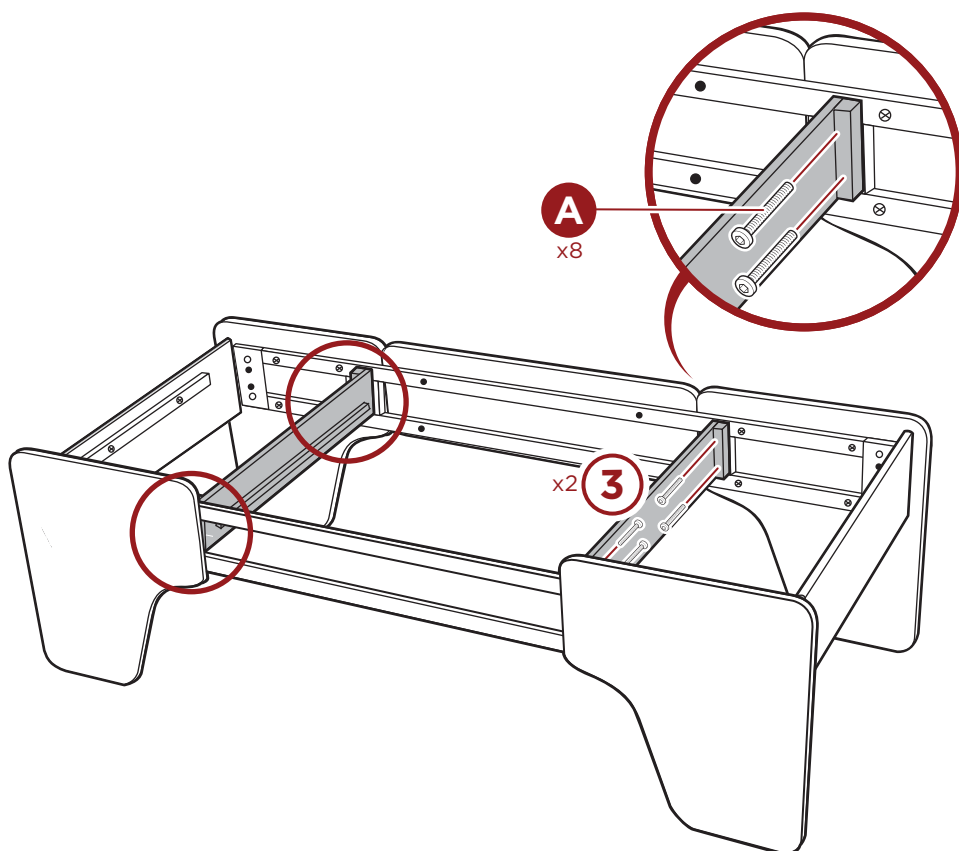

TRAIN TABLE ASSEMBLY

5 Insert the drawer assembly into the part 2 front panel.

Attach two part 12 drawer stoppers to the assembled drawer and two part 3 drawer supports with two part C screws.

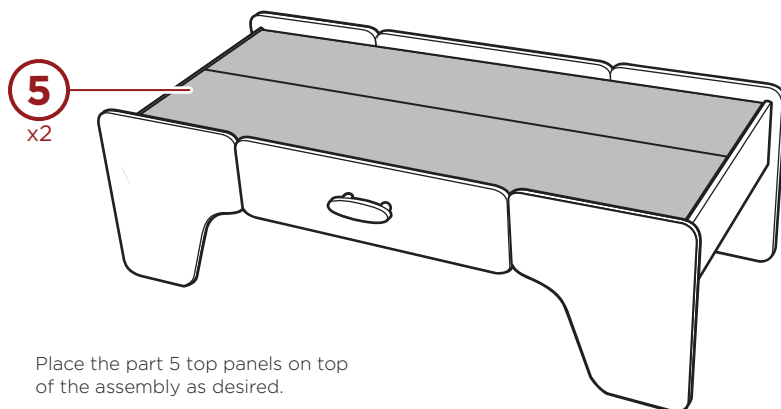
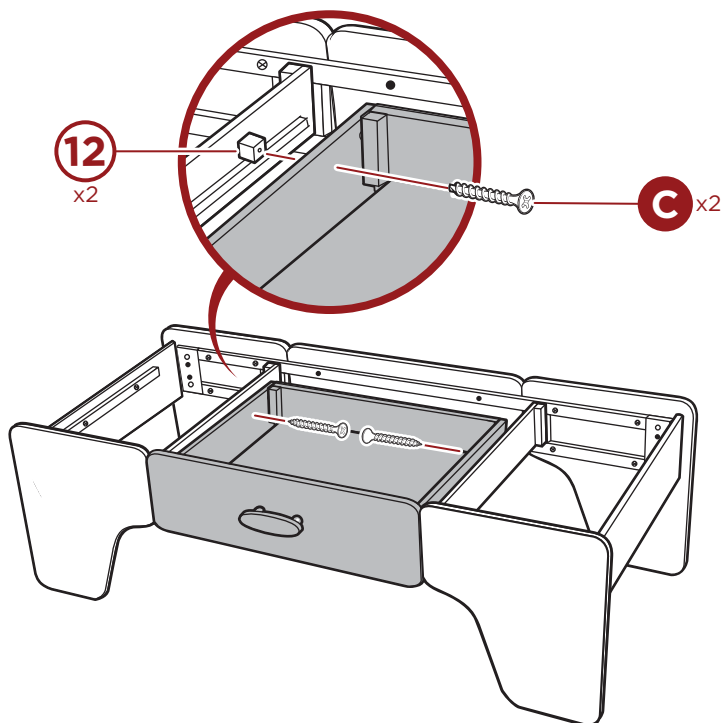

Place the part 5 top panels on top of the assembly as desired.



The part 5 panels are two-sided, with two distinct art faces.

ACCESSORY ASSEMBLY

Play table



*Natural Color Shown

⚠ WARNING

CHOKING HAZARD - Small parts.
Not for children under 3 years old.

⚠ WARNING

ADULT ASSEMBLY REQUIRED

ACHTUNG: Erstickungsgefahr durch kleiner Teile.
Nicht geeignet für Kinder unter 3 Jahren.
Aufbau durch einen Erwachsenen.

ATTENTION: Danger d'étouffement cause des petites pièces.
Ne convient pas à des enfants de moins de 3 ans. Montage réalisé par un adulte.

ADVERTENCIA: PELIGRO DE ASFIXIA! Contiene piezas pequeñas que pueden ser tragadas. No apto para menores de 3 años. Montaje realizado por un adulto.

ATTENZIONE: Parti di dimensioni ridotte. Pericolo di soffocamento. Non adatto a bambini al di sotto dei 3 anni. Montaggio realizzato da un adulto.

WAARSCHUWING: Bevat kleine onderdelen die verstikkingsgevaar kunnen opleveren. Niet geschikt voor kinderen jonger dan 3 jaar. Moet door volwassenen in elkaar worden gezet.

AVISO: PERIGO DE SUFOCAMENTO - Peças pequenas. Não apropriado para crianças com menos de 3 anos de idade. Montagem realizada por um adulto.

Contents

NOTE: Please read instructions before assembly.

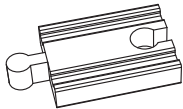

70mm

(A) x 3

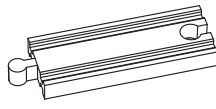

108mm

(B) x 3

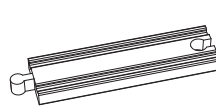

120mm

(C) x 3

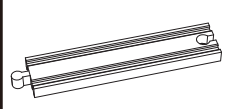

145mm

D x 3

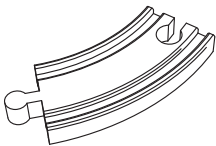

(E) x 18

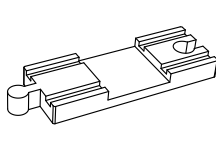

(F) x 1

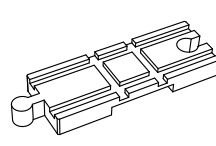

(G) x 1

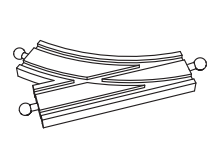

(H) x 1

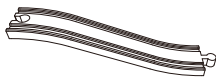

(I) x 1

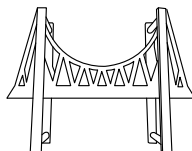

(J) x 1

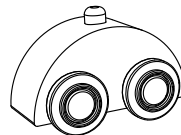



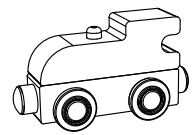



(K) x 2

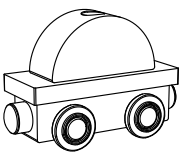
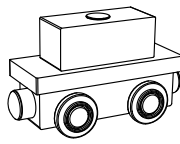
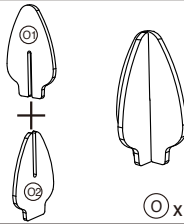
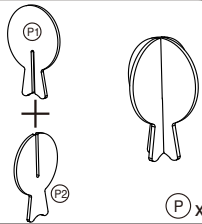
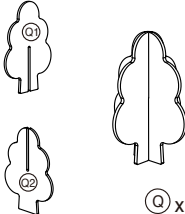
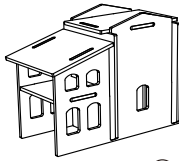
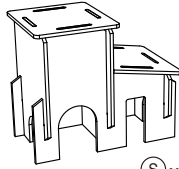

(L) x 1

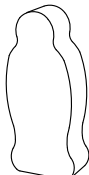
ACCESSORY ASSEMBLY

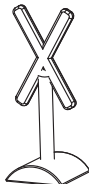
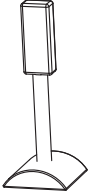
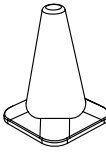
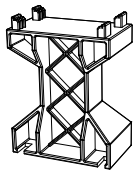
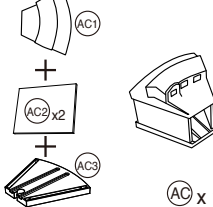
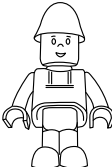
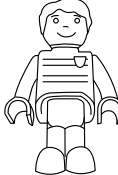
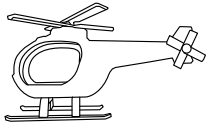
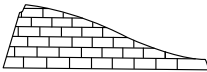
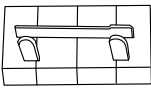
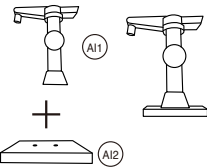
 <p>M x 1</p>	 <p>N x 1</p>	 <p>O x 1</p>	 <p>P x 1</p>
 <p>Q x 1</p>	 <p>R x 1</p>	 <p>S x 2</p>	 <p>T x 2</p>
 <p>U x 5</p>	 <p>V x 1</p>	 <p>W x 1</p>	 <p>X x 1</p>
 <p>Y x 1</p>	 <p>Z x 1</p>	 <p>AA x 2</p>	 <p>AB x 7</p>
 <p>AC x 1</p>	 <p>AD x 1</p>	 <p>AE x 1</p>	 <p>AF x 1</p>
 <p>AG x 1</p>	 <p>AH x 1</p>	 <p>AI x 1</p>	

ACCESSORY ASSEMBLY

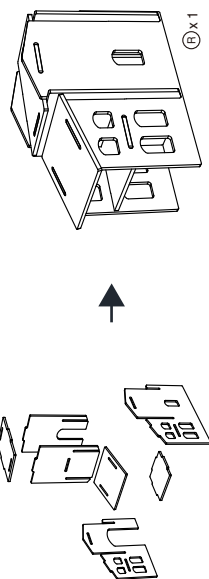
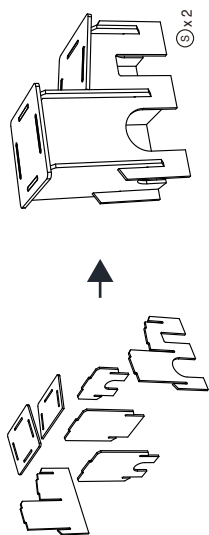
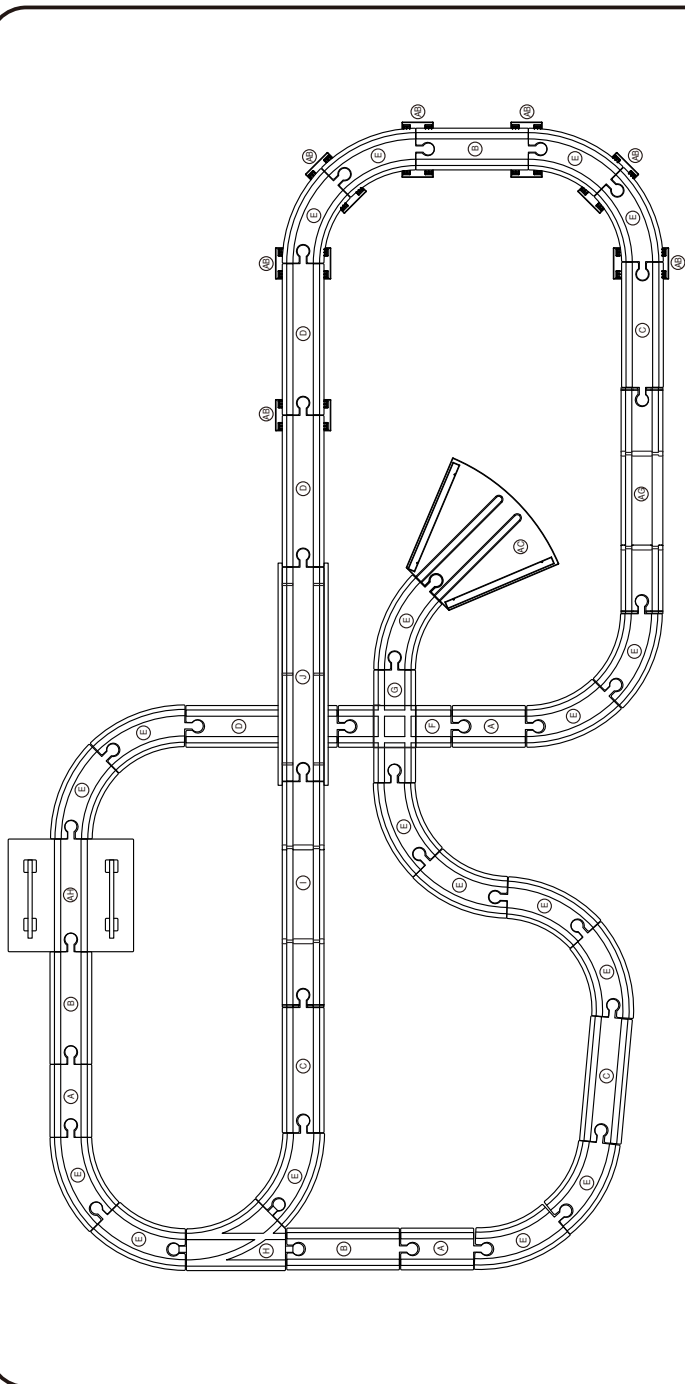



HELP CENTER



Question about your product? We're here to help. Visit us at:

help.bestchoiceproducts.com



Chat Support



Product Inquiry



Orders FAQ



Product Assembly



Returns & Refunds

PRODUCT WARRANTY INFORMATION

All items can be returned for any reason within 60 days of the receipt and will receive a full refund as long as the item is returned in its original product packaging and all accessories from its original shipment are included. All returned items will receive a full refund back to the original payment method. All returned items will not be charged a re-stocking fee.

All returned items require an RA (Return Authorization) number, which can only be provided by a Best Choice Products Customer Service Representative when the return request is submitted. Items received without an RA may not be accepted or may increase your return processing time. Once an item has been received by Best Choice Products, refunds or replacements will be processed within 5 business days.

All returns must be shipped back to the Best Choice Products Return Center at the customer's expense. If the reason for return is a result of an error by Best Choice Products then Best Choice Products will provide a pre-paid shipping label via email. Boxes for return shipping will not be provided by Best Choice Products, and is the customer's responsibility to either use the original shipping boxes or purchase new boxes.

Pictures may be required for some returns to ensure an item is not damaged prior to its return. Items returned are not considered undamaged until they are received by Best Choice Products and verified as such. All damages to items are the customer's responsibility until the item has been received by and acknowledged by Best Choice Products as undamaged.

© Best Choice Products, Inc. All rights reserved. Distributed by Best Choice Products, Inc. Tustin, CA 92780

WARNING

Manufacturer and seller expressly disclaim any and all liability for personal injury, property damage or loss, whether direct, indirect, or incidental, resulting from the incorrect attachment, improper use, inadequate maintenance, unapproved modification, or neglect of this product.