



CHATSWORTH  
PRODUCTS

# Switched Pro eConnect® PDUs

Switched Pro eConnect® PDUs provide remote power monitoring and control for each outlet on the PDU, making it possible to remotely measure and cycle power for each piece of equipment attached to the PDU.

## KEY FEATURES

**Reduced Networking Costs and Complexity** – Secure Array® allows the use of a single IP address for up to 48 connected PDUs (32 when electronic locks are integrated). Second IP address for the entire array provides failover capability.

**Resistance to High Temperature** – Market-leading temperature ratings of up to 149°F (65°C) ensures reliability when mounted toward hot aisles.

**Simplified Load Balancing** – Phase-balance outlets on three-phase models ensure equal loading across all phases; allows use of shorter equipment power cords for better cable and airflow management.

**No Accidental Disconnections** – Patented, low-profile locking outlets prevent accidental disconnections without requiring special cords.

**QuadLock Outlets** – Select configurations with outlets that function as C13/C19 or their high-temperature C15/C21 variants simplify PDU selection, enhance deployment flexibility, and ensure future-proofing.

**Easy Identification of Failover Unit** – Redundancy Pack includes 2 PDUs (one in Black and one in Glacier White) for easy identification of the primary and secondary unit.

**Electronic Lock Integration** – Patented technology seamlessly integrates PDU, environmental sensors and electronic locks into a single hardware and software solution.

**Gigabit Ethernet** – Ensures compatibility with enterprise routers and switches.

**Latest UL Compliance** – Meets UL and IEC 62368 for compliance with new listing requirements for North America and the European Union.

**Cabinet Preinstallation** – Complete ecosystem ships ready for IT equipment integration, and saves deployment time and reduces packaging waste.

**High Power Configurations** – Configurations supporting up to 100A input provide an optimized solution for GPU & AI based applications. 30A branch circuit breakers provide flexibility when plugging high power IT equipment.



Available in Vertical & Horizontal Configurations – Multiple Options Featuring QuadLock Outlets

## Additional Features:

- Individual outlet monitoring and switching; outlet grouping
- Field-replaceable controller module for easy serviceability and upgradeability while maintaining power to critical loads; SD-card transfers PDU configuration
- Bistable latching relays for reduced energy consumption and increased service reliability; maintains last state of power outlet if power is interrupted
- Input and branch circuit monitoring with billing-grade +/-1% accuracy
- Onboard GUI, RESTful API, SNMP v1/v2/v3, Command Line Interface (CLI), RedFish, and native Power IQ® DCIM software integration allows users to easily manage PDUs
- Zero Touch Provisioning (ZTP) automates configuration and provisioning of large deployments of PDUs
- HTTPs support, 802.1x support, RADIUS and LDAP integration for enhanced authentication and security
- Customization capabilities: outlet configurations, color options, power cord length, input connection types and more
- Patent: [chatsworth.com/patents](http://chatsworth.com/patents)
- Made in the United States, TAA-compliant

Availability: US, Canada, Latin America, Europe, Middle East & Africa

**United States & Canada**  
Simi Valley, CA  
800-834-4969  
Toronto, Ontario, Canada  
+905-850-7770  
[chatsworth.com](http://chatsworth.com)  
[techsupport@chatsworth.com](mailto:techsupport@chatsworth.com)

**Latin America**  
Mexico City, Mexico  
+52-55-5203-7525  
Toll Free within Mexico  
800-201-7592  
[chatsworth.com.co](http://chatsworth.com.co)

**Europe**  
Buckinghamshire  
England, UK  
+44-1628-524-834

**Middle East & Africa**  
Dubai, UAE  
+971-4-2602125

**Asia Pacific**  
Jing'an District,  
Shanghai, China  
+86 21 6880-0266  
[chatsworth.com.cn](http://chatsworth.com.cn)



with Globally Sourced Components

## SPECIFICATIONS

Description:	Single-input, vertical and horizontal rack-mount PDUs
Use:	For indoor use in environmentally controlled areas or within environmental enclosures that maintain Operating Conditions (listed below)
Power Input:	<ul style="list-style-type: none"> <li>• Alternating current, 50/60 Hz, 10 ft (3 m) input cord or Terminal Block available as standard; custom lengths between 3 - 15 ft. available</li> <li>• Voltage, maximum current, and inlet/plug type varies per model (see ordering table)</li> </ul>
Power Capacity:	Specific to PDU, limited by circuit breakers or power input (see ordering table)
Power Output:	NEMA 5-20R, Locking IEC C13/C15, Locking C19, Locking QuadLock (C13/C15/C19/C21), specific to PDU with up to 54 outlets (see order table)
Circuit Protection:	<ul style="list-style-type: none"> <li>• UL 489 listed, single- or two-pole, hydraulic-magnetic breakers available on single- and three-phase models with 30A and above input</li> <li>• Low-profile design prevents accidental disconnection</li> <li>• 30A breakers for 208V, 100A; 415V, 60A and 415V, 100A configurations</li> </ul>
Metering:	<ul style="list-style-type: none"> <li>• Input line currents</li> <li>• Voltage, current, power, energy and power factor at branch circuits and individual outlets</li> <li>• +/- 1% billing-grade</li> <li>• Outlet grouping for power charge back reports</li> </ul>
Switching:	<ul style="list-style-type: none"> <li>• Ability to turn on/off and cycle power to individual or group of outlets using bistable latching relays</li> <li>• Ability to name individual outlets to identify attached equipment</li> <li>• Status indicator LED light for individual outlets</li> <li>• Grouping of outlets for consolidated power control</li> </ul>
Local Display: (Vertical PDUs only)	<ul style="list-style-type: none"> <li>• Liquid Crystal Display (LCD) with power-on autotext orientation, color</li> <li>• Provides PDU information; allows initial IP setup, restore defaults and upgrade firmware</li> <li>• Displays voltage, current, power for input lines and breakers</li> <li>• Displays temperature and humidity when optional environmental sensor (P/N 14665-001) is attached to the PDU</li> <li>• Displays alarm notifications – separate LED flashes red on alarm</li> </ul>
Networking:	<ul style="list-style-type: none"> <li>• 10/100/1000MB Ethernet Port</li> <li>• Secure Array IP Consolidation for up to 48 PDUs with no integrated electronic locks or 32 PDUs with integrated electronic locks</li> <li>• Secure Array IP Consolidation supports alternate/failover network connection through a second PDU</li> <li>• Static IP and Dynamic Host Configuration Protocol (DHCP) Support, Zero Touch Provisioning (ZTP)</li> </ul>
Remote Management:	<p>HTTP/HTTPS compatible onboard Web GUI, SNMP v1/v2/v3; RESTful API, CLI, RedFish</p> <p>Native Software Integration:</p> <ul style="list-style-type: none"> <li>- Sunbird Power IQ® DCIM and dcTrack DCIM</li> <li>- ZPE Systems Nodegrid Manager™</li> <li>- RF Code Centerscape Software</li> <li>- Nlyte DCIM</li> </ul>
Console Access:	Through serial console port connection and Command Line Interface (CLI)
Security:	<ul style="list-style-type: none"> <li>• LDAP and Radius Authentication</li> <li>• Password protection</li> <li>• Separate user- and admin-level permissions</li> <li>• Ability to upload custom HTTPS certificate</li> <li>• Secure Shell (SSH)</li> <li>• 802.1x Support</li> </ul>
Controller:	Field-replaceable controller module; SD-card transfers PDU configuration
Firmware:	Flash upgradeable through USB port, Web interface, CLI, API or Power IQ.
Environmental Sensor Integration:	<ul style="list-style-type: none"> <li>• Supports two Temperature &amp; Humidity sensors</li> <li>• USB Type A ports</li> </ul>
Electronic Lock Integration:	<ul style="list-style-type: none"> <li>• Front and rear cabinet door locks (ordered separately) connected to AUX ports on the PDU</li> <li>• Door locks are powered from and remotely accessed through the PDU</li> </ul>
Mounting:	<p>Vertical PDUs: 2 preinstalled tool-less mounting buttons; adjustable positions / Top or bottom power cord entry orientation</p> <p>Horizontal PDUs: Include rack-mount brackets for 19"EIA (482.6 mm) racks</p>
Grounding/Bonding:	<ul style="list-style-type: none"> <li>• Bonded power inlet/plug and external bond connection with a threaded M5 attachment point</li> <li>• Includes a bonding kit for CPI cabinets</li> </ul>
Color Options:	<ul style="list-style-type: none"> <li>• Black or Glacier White available as standard options; other colors available as custom solutions</li> <li>• Redundancy Pack includes (1) Black PDU and (1) Glacier White PDU</li> </ul>
Operating Conditions:	<ul style="list-style-type: none"> <li>• Temperature: 32°F – 149°F (0°C – 65°C) at Input Power Rating (kW) for units with 20A breakers; at 50% load for unit with 30A breakers</li> <li>• Relative Humidity: 5% – 95%, noncondensing</li> <li>• Elevation: 0 – 10,000' (0 – 3,000 m)</li> </ul>
Storage/ Non-operating Conditions:	<ul style="list-style-type: none"> <li>• Temperature: -13°F – 149°F (-25°C – 65°C)</li> <li>• Relative Humidity: 5% – 95%, noncondensing</li> <li>• Elevation: 0 – 50,000' (0 – 15,000 m)</li> </ul>
Shipping Weight:	<p>Vertical PDUs: 27 lb (12 kg) single unit; 54 lb (24 kg) Redundancy Pack</p> <p>Horizontal PDUs:</p> <ul style="list-style-type: none"> <li>- 1U is 18 lb (8.2 kg) single unit; 35 lb (15.9 kg) Redundancy Pack</li> <li>- 2U is 23 lb (10.4 kg) single unit; 45 lb (20.4 kg) Redundancy Pack</li> </ul>
Certifications:	<ul style="list-style-type: none"> <li>• NEMKO certified to UL/IEC62368, CE (EU), FCC Part 15, Class A, EN 55022, RoHS Compliant</li> <li>• Patent: chatsworth.com/patents</li> </ul>
Warranty:	3 years standard with advanced replacement; 2 additional years optional

**VERTICAL CONFIGURATION**

Use Vertical eConnect PDUs in data centers and equipment rooms with 42U or higher racks, cabinets and enclosures to provide power connections alongside equipment for higher-density applications. Use Redundancy Pack to support redundant power circuits.

**Hydraulic-Magnetic Breakers**



**Status LED Light**



**Locking Outlets**

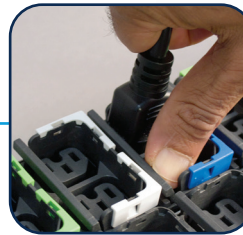

**New! QuadLock Outlet Configurations**

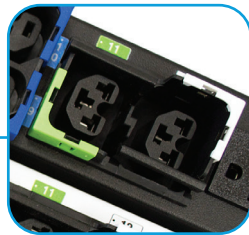

**Color-Coded Tabs on Outlets**



**Field-Replaceable Controller Module for Vertical eConnect PDUs**



- 1 Proprietary Auxiliary Ports for Lock Kits
- 2 Serial Console Port - USB Mini Type B
- 3 Status LED
- 4 Ethernet Port - RJ45
- 5 Serial Console Port - RJ45
- 6 USB Type A Ports for Firmware and Temperature/Humidity Sensors
- 7 Secure Array Ports - RJ45 - for linking of up to 48 PDUs
- 8 LCD Local Display

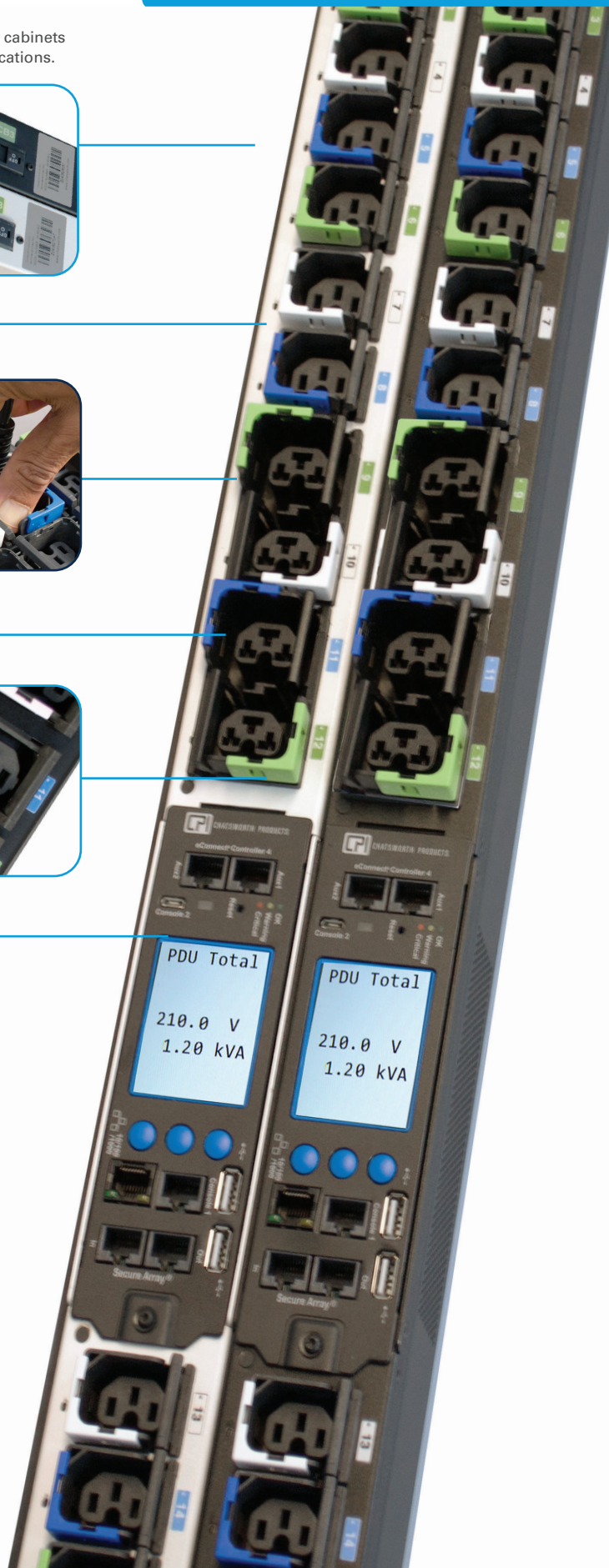

## ORDERING INFORMATION

Switched Pro eConnect PDU, Vertical - North America							
Part Number			Input Amperage	Input Plug	Outlets	kW Capacity (UL)	Cabinet Compatibility
Black	Glacier White	Redundancy Pack**					
<b>120 Volt, Single-Phase Input</b>							
EA-6001-C	EA-6001-E	EA-6001-CE	20A	NEMA L5-20P	(24) 5-20	1.9 kW	42U & higher
EA-6002-C	EA-6002-E	EA-6002-CE	30A	NEMA L5-30PP	(24) 5-20	2.9 kW	42U & higher
<b>208 Volt, Single-Phase Input</b>							
EA-6069-C	EA-6069-E	EA-6069-CE	20A	NEMA L6-20	(18) C13 + (6) C19	3.3 kW	42U & higher
EA-6070-C	EA-6070-E	EA-6070-CE	20A	NEMA L6-20P	(24) C13	3.3 kW	42U & higher
EA-60B8W-C	EA-60B8W-E	EA-60B8W-CE	20A	NEMA L6-20P	(12) C13+(12) QuadLock	3.3 kW	42U or Higher
EA-60C8W-C	EA-60C8W-E	EA-60C8W-CE	20A	NEMA L6-20P	(18) C13 + (18) QuadLock	3.3 kW	42U or Higher
EA-6004-C	EA-6004-E	EA-6004-CE	30A	NEMA L6-30P	(24) C13	5 kW	42U & higher
EA-6012-C	EA-6012-E	EA-6012-CE	30A	NEMA L6-30P	(18) C13 + (6) C19	5 kW	42U & higher
EA-60B9W-C	EA-60B9W-E	EA-60B9W-CE	30A	NEMA L6-30P	(12) C13 + (12) QuadLock	5 kW	42U or Higher
EA-60C9W-C	EA-60C9W-E	EA-60C9W-CE	30A	NEMA L6-30P	(18) C13 + (18) QuadLock	5 kW	42U or Higher
<b>120/208V, Single-Phase Input</b>							
EA-60C2W-C	EA-60C2W-E	EA-60C2W-CE	30A	NEMA L14-30P	(12) C13 + (12) QuadLock	5 kW	42U or Higher
EA-60D2W-C	EA-60D2W-E	EA-60D2W-CE	30A	NEMA L14-30P	(18) C13 +(18) QuadLock	5 kW	42U or Higher
EA-60H2W-C	EA-60H2W-E	EA-60H2W-CE	30A	NEMA L14-30P	(12) C13 + (12) QuadLock + (2) 5-20	5 kW	42U or Higher
<b>120/208 Volt, Three-Phase Input***</b>							
EA-6006-C	EA-6006-E	EA-6006-CE	20A	NEMA L21-20P	(24) C13	5.7 kW	42U & higher
EA-6014-C	EA-6014-E	EA-6014-CE	20A	NEMA L21-20P	(18) C13 + (6) C19	5.7 kW	42U & higher
EA-6025-C	EA-6025-E	EA-6025-CE	20A	NEMA L21-20P	(18) C13 + (6) C19 + (3) 5-20 convenience outlets***	5.7 kW	42U & higher
EA-60C3W-C	EA-60C3W-E	EA-60C3W-CE	20A	NEMA L21-20P	(12) C13 + (12) QuadLock	5.7 kW	42U & higher
EA-60D3W-C	EA-60D3W-E	EA-60D3W-CE	20A	NEMA L21-20P	(18) C13 + (18) QuadLock	5.7 kW	42U & higher
EA-60E6W-C	EA-60E6W-E	EA-60E6W-CE	20A	NEMA L21-20P	(12) C13 + (12) QuadLock + (3) 5-20	5.7 kW	42U & higher
EA-6007-C	EA-6007-E	EA-6007-CE	30A	NEMA L21-30P	(24) C13	8.6 kW	42U & higher
EA-6015-C	EA-6015-E	EA-6015-CE	30A	NEMA L21-30P	(18) C13 + (6) C19	8.6 kW	42U & higher
EA-6026-C	EA-6026-E	EA-6026-CE	30A	NEMA L21-30P	(18) C13 + (6) C19 + (3) 5-20 convenience outlets***	8.6 kW	42U & higher
EA-6035-C	EA-6035-E	EA-6035-CE	30A	NEMA L21-30P	(36) C13	8.6 kW	42U & higher
EA-6772-C*	EA-6772-E*	EA-6772-CE*	30A	NEMA L21-30P	(36) C13 + (12) C19	8.6 kW	45U & higher
EA-6753-C*	EA-6753-E*	EA-6753-CE*	30A	NEMA L21-30P	(48) C13	8.6 kW	45U & higher
EA-60C4W-C	EA-60C4W-E	EA-60C4W-CE	30A	NEMA L21-30P	(12) C13 + (12) QuadLock	8.6 kW	42U & higher
EA-60D4W-C	EA-60D4W-E	EA-60D4W-CE	30A	NEMA L21-30P	(18) C13 + (18) QuadLock	8.6 kW	42U & higher
EA-60E7W-C	EA-60E7W-E	EA-60E7W-CE	30A	NEMA L21-30P	(12) C13 + (12) QuadLock + (3) 5-20	8.6 kW	42U & higher
EA-67E8W-C	EA-67E8W-E	EA-67E8W-CE	30A	NEMA L21-30P	(24) C13+ (24) QuadLock	8.6 kW	45U & higher

Notes: \*These configurations are 3.8" wide. All other vertical configurations are 2.2" wide.

\*\*Redundancy Pack includes 2 PDUs in Black and Glacier White for easy identification of the primary and secondary unit.

\*\*\*Convenience 5-20 outlets do not provide monitoring or switching capabilities.

ORDERING INFORMATION

Switched Pro eConnect PDU, Vertical - North America							
Part Number			Input Amperage	Input Plug	Outlets	kW Capacity (UL)	Cabinet Compatibility
Black	Glacier White	Redundancy Pack**					
<b>208 Volt, Three-Phase Input</b>							
EA-6005-C	EA-6005-E	EA-6005-CE	30A	NEMA L15-30P	(24) C13	8.6 kW	42U & higher
EA-6013-C	EA-6013-E	EA-6013-CE	30A	NEMA L15-30P	(18) C13 + (6) C19	8.6 kW	42U & higher
EA-6034-C	EA-6034-E	EA-6034-CE	30A	NEMA L15-30P	(36) C13	8.6 kW	42U & higher
EA-6771-C*	EA-6771-E*	EA-6771-CE	30A	NEMA L15-30P	(36) C13 + (12) C19	8.6 kW	45U & higher
EA-6752-C*	EA-6752-E*	EA-6752-CE*	30A	NEMA L15-30P	(48) C13	8.6 kW	45U & higher
EA-60C5W-C	EA-60C5W-E	EA-60C5W-CE	30A	NEMA L15-30P	(12) C13 + (12) QuadLock	8.6 kW	42U & higher
EA-60D5W-C	EA-60D5W-E	EA-60D5W-CE	30A	NEMA L15-30P	(18) C13 + (18) QuadLock	8.6 kW	42U & higher
EA-67E9W-C	EA-67E9W-E	EA-67E9W-CE	30A	NEMA L15-30P	(24) C13+ (24) QuadLock	8.6 kW	45U & higher
EA-6762-C	EA-6762-E*	EA-6762-CE*	50A	NEMA L21-30P	(36) C13 + (12) C19	8.6 kW	45U & higher
EA-6016-C	EA-6016-E	EA-6016-CE	50A	CS8365	(18) C13 + (6) C19	14.4 kW	42U & higher
EA-6027-C	EA-6027-E	EA-6027-CE	50A	CS8365	(12) C13 + (12) C19	14.4 kW	42U & higher
EA-6136-C	EA-6136-E	EA-6136-CE	50A	CS8365	(36) C13	14.4 kW	45U & higher
EA-6144-C	EA-6144-E	EA-6144-CE	50A	CS8365	(24) C13 + (12) C19	14.4 kW	45U & higher
EA-6754-C*	EA-6754-E*	EA-6754-CE*	50A	CS8365	(48) C13	14.4 kW	45U & higher
EA-6027W-C	EA-6027W-E	EA-6027W-CE	50A	CS8365	(12) C13 + (12) QuadLock	14.4 kW	42U & higher
EA-61D6W-C	EA-61D6W-E	EA-61D6W-CE	50A	CS8365	(18) C13 + (18) QuadLock	14.4 kW	45U & higher
EA-61D6W-C	EA-61D6W-E	EA-61D6W-CE	50A	CS8365	(18) C13 + (18) QuadLock	14.4 kW	45U & higher
EA-67F0W-C	EA-67F0W-E	EA-67F0W-CE	50A	CS8365	(24) C13 + (24) QuadLock	14.4kW	45U & higher
EA-6017-C	EA-6017-E	EA-6017-CE	60A	IEC 60309 60A 3P+E	(18) C13 + (6) C19	17.2 kW	42U & higher
EA-6028-C	EA-6028-E	EA-6028-CE	60A	IEC 60309 60A 3P+E	(12) C13 + (12) C19	17.2 kW	42U & higher
EA-6137-C	EA-6137-E	EA-6137-CE	60A	IEC 60309 60A 3P+E	(36) C13	17.2 kW	45U & higher
EA-6145-C	EA-6145-E	EA-6145-CE	60A	IEC 60309 60A 3P+E	(24) C13 + (12) C19	17.2 kW	45U & higher
EA-6763-C*	EA-6763-E*	EA-6763-CE*	60A	IEC 60309 60A 3P+E	(36) C13 + (12) C19	17.2 kW	45U & higher
EA-6755-C*	EA-6755-E*	EA-6755-CE*	60A	IEC 60309 60A 3P+E	(48) C13	17.2 kW	45U & higher
EA-6028W-C	EA-6028W-E	EA-6028W-CE	60A	IEC 60309 60A 3P+E	(12) C13 + (12) QuadLock	17.2 kW	42U & higher
EA-61D7W-C	EA-61D7W-E	EA-61D7W-CE	60A	IEC 60309 60A 3P+E	(18) C13 + (18) QuadLock	17.2 kW	45U & higher
EA-67F1W-C	EA-67F1W-E	EA-67F1W-CE	60A	IEC 60309 60A 3P+E	(24) C13 + (24) QuadLock	17.2 kW	45U & higher
EA-67F2W-C	EA-67F2W-E	EA-67F2W-CE	100A	IEC 60309 100A 3P+E	(24) C13 + (24) QuadLock	28.8 kW	45U & higher
EA-61D8W-C	EA-61D8W-E	EA-61D8W-CE	100A	IEC 60309 100A 3P+E	(18) C13 + (18) QuadLock	28.8 kW	45U & higher
EA-60C6W-C	EA-60C6W-E	EA-60C6W-CE	100A	IEC 60309 100A 3P+E	(12) C13 + (12) QuadLock	28.8 kW	42U & higher
EA-61B1-C	EA-61B1-E	EA-61B1-CE	100A	IEC 60309 100A 3P+E	(24) C13 + (12) C19	28.8 kW	45U & higher
EA-67B3-C*	EA-67B3-E*	EA-67B3-CE*	100A	IEC 60309 100A 3P+E	(36) C13 + (12) C19	28.8 kW	45U & higher
EA-67B4-C*	EA-67B4-E*	EA-67B4-CE*	100A	IEC 60309 100A 3P+E	(48) C13	28.8 kW	45U & higher
EA-6150-C	EA-6150-E	EA-6150-CE	100A	AC Terminal Block 3P+E	(24) C13 + (12) C19	28.8 kW	45U & higher
EA-6767-C*	EA-6767-E*	EA-6767-CE*	100A	AC Terminal Block 3P+E	(36) C13 + (12) C19	28.8 kW	45U & higher
EA-6760-C*	EA-6760-E*	EA-6760-CE*	100A	AC Terminal Block 3P+E	(48) C13	28.8 kW	45U & higher
EA-61D9W-C	EA-61D9W-E	EA-61D9W-CE	100A	AC Terminal Block 3P+E	(18) C13 + (18) QuadLock	28.8 kW	45U & higher
EA-67F3W-C	EA-67F3W-E	EA-67F3W-CE	100A	AC Terminal Block 3P+E	(24) C13 + (24) QuadLock	28.8 kW	45U & higher

Notes: \*These configurations are 3.8" wide. All other vertical configurations are 2.2" wide.  
 \*\*Redundancy Pack includes 2 PDUs in Black and Glacier White for easy identification of the primary and secondary unit.  
 \*\*\*Convenience 5-20 outlets do not provide monitoring or switching capabilities.

## ORDERING INFORMATION

Switched Pro eConnect PDU, Vertical - North America							
Part Number			Input Amperage	Input Plug	Outlets	kW Capacity (UL)	Cabinet Compatibility
Black	Glacier White	Redundancy Pack**					
<b>240/415 Volt, Three-Phase Input</b>							
EA-6018-C	EA-6018-E	EA-6018-CE	30A	NEMA L22-30P	(18) C13 + (6) C19	17.2 kW	42U & higher
EA-6029-C	EA-6029-E	EA-6029-CE	30A	NEMA L22-30P	(12) C13 + (12) C19	17.2 kW	42U & higher
EA-6038-C	EA-6038-E	EA-6038-CE	30A	NEMA L22-30P	(36) C13	17.2 kW	42U & higher
EA-6046-C	EA-6046-E	EA-6046-CE	30A	NEMA L22-30P	(24) C13 + (12) C19	17.2 kW	42U & higher
EA-6029W-C	EA-6029W-E	EA-6029W-CE	30A	NEMA L22-30P	(12) C13 + (12) QuadLock	17.2 kW	42U & higher
EA-60E0W-C	EA-60E0W-E	EA-60E0W-CE	30A	NEMA L22-30P	(18) C13 + (18) QuadLock	17.2 kW	42U & higher
EA-67F4W-C	EA-67F4W-E	EA-67F4W-CE	30A	NEMA L22-30P	(24) C13 + (24) QuadLock	17.2 kW	45U & higher

Notes: \*These configurations are 3.8" wide. All other vertical configurations are 2.2" wide.

\*\*Redundancy Pack includes 2 PDUs in Black and Glacier White for easy identification of the primary and secondary unit.

Switched Pro eConnect PDU, Vertical - Worldwide								
Part Number			Input Amperage	Input Plug	Outlets	kW Capacity Worldwide (CE)	kW Capacity North America (UL)	Cabinet Compatibility
Black	Glacier White	Redundancy Pack**						
<b>220 - 240 Volt, Single-Phase Input</b>								
EA-6008-C	EA-6008-E	EA-6008-CE	16A	C20 Inlet to IEC 60309 16A 1P+N+E	(24) C13	3.8 kW	3.8 kW	42U & higher
EA-6019-C	EA-6019-E	EA-6019-CE	16A	C20 Inlet to IEC 60309 16A 1P+N+E	(18) C13 + (6) C19	3.8 kW	3.8 kW	42U & higher
EA-60C0W-C	EA-60C0W-E	EA-60C0W-CE	16A	C20 inlet to IEC 60309 16A 1P+N+E	(12) C13 + (12) QuadLock	3.8 kW	3.8 kW	42U & higher
EA-60D0W-C	EA-60D0W-E	EA-60D0W-CE	16A	C20 inlet to IEC 60309 16A 1P+N+E	(18) C13 + (18) QuadLock	3.8 kW	3.8 kW	42U & higher
EA-6009-C	EA-6009-E	EA-6009-CE	32A	IEC 60309 32A 1P+N+E	(24) C13	7.7 kW	6.1 kW	42U & higher
EA-6020-C	EA-6020-E	EA-6020-CE	32A	IEC 60309 32A 1P+N+E	(18) C13 + (6) C19	7.7 kW	6.1 kW	42U & higher
EA-60C1W-C	EA-60C1W-E	EA-60C1W-CE	32A	IEC 60309 32A 1P+N+E	(12) C13 + (12) QuadLock	7.7 kW	6.1 kW	42U & higher
EA-60D1W-C	EA-60D1W-E	EA-60D1W-CE	32A	IEC 60309 32A 1P+N+E	(18) C13 + (18) QuadLock	7.7 kW	6.1 kW	42U & higher

Notes: \*\*Redundancy Pack includes 2 PDUs in Black and Glacier White for easy identification of the primary and secondary unit.

\*\*\*Convenience 5-20 outlets do not provide monitoring or switching capabilities.

## ORDERING INFORMATION

Switched Pro eConnect PDU, Vertical - Worldwide								
Part Number			Input Amperage	Input Plug	Outlets	kW Capacity Worldwide (CE)	kW Capacity North America (UL)	Cabinet Compatibility
Black	Glacier White	Redundancy Pack**						
<b>220 - 240/380 - 415 Volt, Three-Phase Input</b>								
EA-6010-C	EA-6010-E	EA-6010-CE	16A	IEC 60309 16A 3P+N+E	(24) C13	11.5 kW	11.5 kW	42U & higher
EA-6021-C	EA-6021-E	EA-6021-CE	16A	IEC 60309 16A 3P+N+E	(18) C13 + (6) C19	11.5 kW	11.5 kW	42U & higher
EA-6030-C	EA-6030-E	EA-6030-CE	16A	IEC 60309 16A 3P+N+E	(12) C13 + (12) C19	11.5 kW	11.5 kW	42U & higher
EA-6039-C	EA-6039-E	EA-6039-CE	16A	IEC 60309 16A 3P+N+E	(36) C13	11.5 kW	11.5 kW	42U & higher
EA-6047-C	EA-6047-E	EA-6047-CE	16A	IEC 60309 16A 3P+N+E	(24) C13 + (12) C19	11.5 kW	11.5 kW	42U & higher
EA-6030W-C	EA-6030W-E	EA-6030W-CE	16A	IEC 60309 16A 3P+N+E	(12) C13 + (12) QuadLock	11.5 kW	11.5 kW	42U & higher
EA-60E1W-C	EA-60E1W-E	EA-60E1W-CE	16A	IEC 60309 16A 3P+N+E	(18) C13 + (18) QuadLock	11.5 kW	11.5 kW	42U & higher
EA-67F5W-C	EA-67F5W-E	EA-67F5W-CE	16A	IEC 60309 16A 3P+N+E	(24) C13 + (24) QuadLock	11.5k W	11.5 kW	45U or higher
EA-6022-C	EA-6022-E	EA-6022-CE	32A	IEC 60309 32A 3P+N+E	(18) C13 + (6) C19	23 kW	18.4 kW	42U & higher
EA-6031-C	EA-6031-E	EA-6031-CE	32A	IEC 60309 32A 3P+N+E	(12) C13 + (12) C19	23 kW	18.4 kW	42U & higher
EA-6040-C	EA-6040-E	EA-6040-CE	32A	IEC 60309 32A 3P+N+E	(36) C13	23 kW	18.4 kW	42U & higher
EA-6048-C	EA-6048-E	EA-6048-CE	32A	IEC 60309 32A 3P+N+E	(24) C13 + (12) C19	23 kW	18.4 kW	42U & higher
EA-6765-C*	EA-6765-E*	EA-6765-CE*	32A	IEC60309 32A 3P+N+E	(36) C13 + (12) C19	23 kW	23.0 kW	45U & higher
EA-6758-C*	EA-6758-E*	EA-6758-CE*	32A	EC60309 32A 3P+N+E	(48) C13	23 kW	23.0 kW	45U & higher
EA-6031W-C	EA-6031W-E	EA-6031W-CE	32A	IEC 60309 32A 3P+N+E	(12) C13 + (12) QuadLock	23 kW	23.0 kW	42U & higher
EA-60E2W-C	EA-60E2W-E	EA-60E2W-CE	32A	IEC 60309 32A 3P+N+E	(18) C13 + (18) QuadLock	23 kW	23.0 kW	42U & higher
EA-67F6W-C	EA-67F6W-E	EA-67F6W-CE	32A	IEC 60309 32A 3P+N+E	(24) C13 + (24) QuadLock	23 kW	23.0 kW	45U & higher
EA-6049-C	EA-6049-E	EA-6049-CE	60A	IEC 60309 60A 3P+N+E	(24) C13 + (12) C19	34.5 kW	34.5 kW	42U & higher
EA-6766-C*	EA-6766-E*	EA-6766-CE*	60A	IEC 60309 60A 3P+N+E	(36) C13 + (12) C19	34.5 kW	34.5 kW	45U & higher
EA-6759-C*	EA-6759-E*	EA-6759-CE*	60A	IEC 60309 60A 3P+N+E	(48) C13	34.5 kW	34.5 kW	45U & higher
EA-60C7W-C	EA-60C7W-E	EA-60C7W-CE	60A	IEC 60309 60/63A 3P+N+E	(12) C13+(12) QuadLock	34.5kW	34.5kW	42U & higher
EA-60E3W-C	EA-60E3W-E	EA-60E3W-CE	60A	IEC 60309 60/63A 3P+N+E	(18) C13 + (18) QuadLock	34.5kW	34.5kW	45U & higher
EA-67F7W-C	EA-67F7W-E	EA-67F7W-CE	60A	IEC 60309 60/63A 3P+N+E	(24) C13 + (24) QuadLock	34.5kW	34.5kW	45U & higherr
EA-6768-C*	EA-6768-E*	EA-6768-CE*	60A	Terminal Block 3P+N+E	(36) C13 + (12) C19	34.5 kW	34.5 kW	45U & higher
EA-6761-C*	EA-6761-E*	EA-6761-CE*	60A	Terminal Block 3P+N+E	(48) C13	34.5 kW	34.5 kW	45U & higher
EA-67B7-C*	EA-67B7-E*	EA-67B7-CE	100A	Terminal Block 3P+N+E	(24) C13 + (24) C19	57.5 kW	57.5 kW	45U & higher
EA-67B6-C*	EA-67B6-E*	EA-67B6-CE*	100A	IEC60309 100A 3P+N+E	(24) C13 + (24) C19	57.5 kW	57.5 kW	45U & higher
EA-61B5-C	EA-61B5-E	EA-61B5-CE	100A	IEC60309 100A 3P+N+E	(18) C13 + (18) C19	51.8 kW	51.8 kW	45U & higher
EA-61E4W-C	EA-61E4W-E	EA-61E4W-CE	100A	IEC60309 100A 3P+N+E	(18) C13 + (18) QuadLock	51.8 kW	51.8 kW	45U & higher
EA-67F8W-C	EA-67F8W-E	EA-67F8W-CE	100A	IEC60309 100A 3P+N+E	(24) C13 +( 24) QuadLock	51.8 kW	51.8 kW	45U & higher
EA-67B7W-C	EA-67B7W-E	EA-67B7W-CE	100A	Terminal Block 3P+N+E	(24) C13 + (24) QuadLock	51.8 kW	51.8 kW	45U & higher

Notes: \*\*Redundancy Pack includes 2 PDUs in Black and Glacier White for easy identification of the primary and secondary unit.

\*\*\*Convenience 5-20 outlets do not provide monitoring or switching capabilities.

**HORIZONTAL CONFIGURATIONS**

Use Horizontal eConnect PDUs in applications that require outlets at the top or bottom of cabinets for quick access, low- to medium-density applications that require fewer connections and in distributed infrastructure for edge applications. Horizontal PDUs are available in 1U and 2U heights with up to 24 outlets.

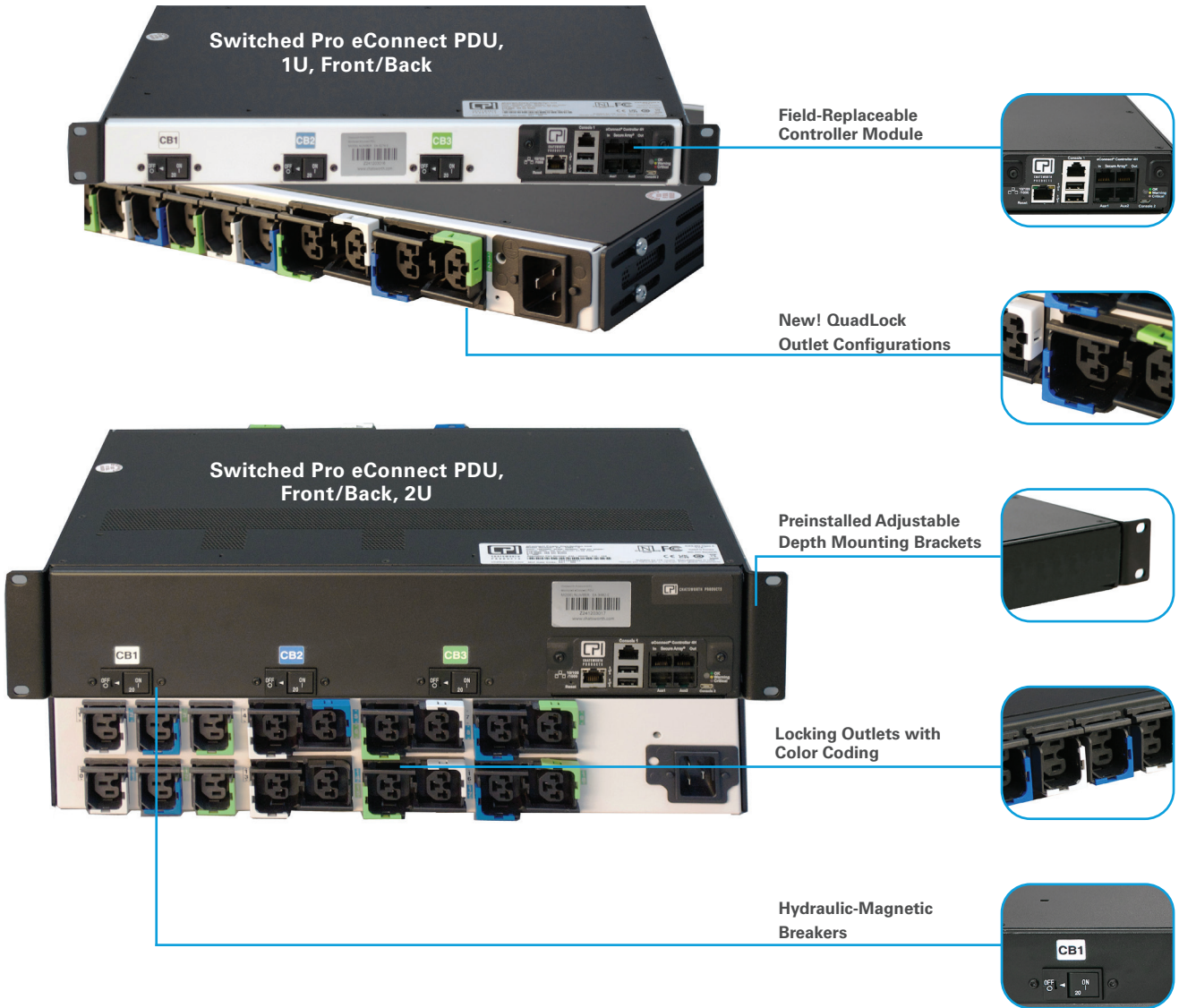

**Field-Replaceable Controller Module for Horizontal eConnect PDUs**

- 1 Proprietary Auxiliary Ports for Lock Kits
- 2 Console 2 Port - USB
- 3 Status LED
- 4 Ethernet Port - RJ45
- 5 Console 1 Port - RJ45
- 6 USB Type A Ports for Firmware and Temperature/Humidity Sensors
- 7 Secure Array/PDU Linking/Serial Port (link-in)
- 8 Secure Array/PDU Linking/Serial Port (link-out)

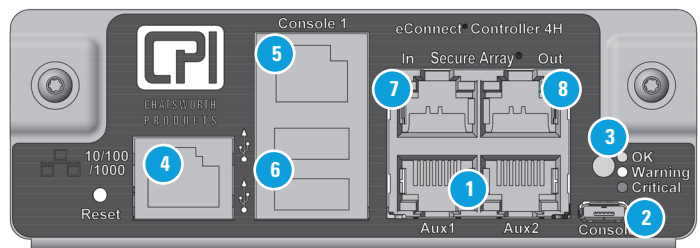

Note: Horizontal eConnect PDUs do not have a LCD Local Display.

ORDERING INFORMATION

Switched Pro eConnect PDU, Horizontal - North America								
Part Number			Input Amperage	Input Plug	Outlets	kW Capacity (UL)	Form Factor (U) Height	
Black	Glacier White	Redundancy Pack**						
<b>120 Volt, Single-Phase Input</b>								
EA-6274-C	EA-6274-E	EA-6274-CE	20A	NEMA L5-20P	(12) 5-20	1.9 kW	1U	
EA-6275-C	EA-6275-E	EA-6275-CE	30A	NEMA L5-30P	(12) 5-20	2.9 kW	1U	
<b>208 Volt, Single-Phase Input</b>								
EA-6276-C	EA-6276-E	EA-6276-CE	20A	NEMA L6-20P	(12) C13	3.3 kW	1U	
EA-6293-C	EA-6293-E	EA-6293-CE	20A	NEMA L6-20P	(8) C13 + (4) C19	3.3 kW	1U	
EA-6293W-C	EA-6293W-E	EA-6293W-CE	20A	NEMA L6-20P	(8) C13 + (4) QuadLock	3.3 kW	1U	
EA-6277-C	EA-6277-E	EA-6277-CE	30A	NEMA L6-30P	(12) C13	5 kW	1U	
EA-6284-C	EA-6284-E	EA-6284-CE	30A	NEMA L6-30P	(9) C19	5 kW	1U	
EA-6294W-C	EA-6294W-E	EA-6294W-CE	30A	NEMA L6-30P	(8) C13 + (4) QuadLock	5 kW	1U	
EA-6294-C	EA-6294-E	EA-6294-CE	30A	NEMA L6-30P	(8) C13 + (4) C19	5 kW	1U	
<b>120/208V, Single-Phase Input</b>								
EA-62F9W-C	EA-62F9W-E	EA-62F9W-CE	30A	NEMA L14-30P	(8) C13 + (4) QuadLock	5 kW	1U	
<b>120/208 Volt, Three-Phase Input</b>								
EA-6279-C	EA-6279-E	EA-6279-CE	20A	NEMA L21-20P	(12) C13	5.7 kW	1U	
EA-6286-C	EA-6286-E	EA-6286-CE	20A	NEMA L21-20P	(9) C19	5.7 kW	1U	
EA-6296-C	EA-6296-E	EA-6296-CE	20A	NEMA L21-20P	(8) C13 + (4) C19	5.7 kW	1U	
EA-6296W-C	EA-6296W-E	EA-6296W-CE	20A	NEMA L21-20P	(8) C13 + (4)QuadLock	5.7 kW	1U	
EA-6280-C	EA-6280-E	EA-6280-CE	30A	NEMA L21-30P	(12) C13	8.6 kW	1U	
EA-6287-C	EA-6287-E	EA-6287-CE	30A	NEMA L21-30P	(9) C19	8.6 kW	1U	
EA-6297-C	EA-6297-E	EA-6297-CE	30A	NEMA L21-30P	(8) C13 + (4) C19	8.6 kW	1U	
EA-6297W-C	EA-6297W-E	EA-6297W-CE	30A	NEMA L21-30P	(8) C13+ (4)QuadLock	8.6 kW	1U	
<b>208 Volt, Three-Phase Input</b>								
EA-6278-C	EA-6278-E	EA-6278-CE	30A	NEMA L15-30P	(12) C13	8.6 kW	1U	
EA-6285-C	EA-6285-E	EA-6285-CE	30A	NEMA L15-30P	(9) C19	8.6 kW	1U	
EA-6295-C	EA-6295-E	EA-6295-CE	30A	NEMA L15-30P	(8) C13 + (4) C19	8.6 kW	1U	
<b>Switched Pro eConnect PDU, Horizontal - Worldwide</b>								
Part Number			Input Amperage	Input Plug	Outlets	kW Capacity Worldwide (CE)	kW Capacity North America (UL)	Form Factor (U) Height
Black	Glacier White	Redundancy Pack**						
<b>220 - 240 Volt, Single-Phase Input</b>								
EA-6281-C	EA-6281-E	EA-6281-CE	16A	C20 Inlet to IEC 60309 16A 1P+N+E	(12) C13	3.8 kW	3.8 kW	1U
EA-6298-C	EA-6298-E	EA-6298-CE	16A	C20 Inlet to IEC 60309 16A 1P+N+E	(8) C13 + (4) C19	3.8 kW	3.8 kW	1U
EA-6298W-C	EA-6298W-E	EA-6298W-CE	16A	C20 inlet to IEC 60309 16A 1P+N+E	(8) C13 + (4) QuadLock	3.8 kW	3.8 kW	1U
EA-6283-C	EA-6283-E	EA-6283-CE	32A	IEC 60309 32A 1P+N+E	(12) C13	7.7 kW	6.1 kW	1U
EA-6289-C	EA-6289-E	EA-6289-CE	32A	IEC 60309 32A 1P+N+E	(9) C19	7.7 kW	6.1 kW	1U
EA-62A0-C	EA-62A0-E	EA-62A0-CE	32A	IEC 60309 32A 1P+N+E	(8) C13 + (4) C19	7.7 kW	6.1 kW	1U
EA-62A0W-C	EA-62A0W-E	EA-62A0W-CE	32A	IEC 60309 32A 1P+N+E	(8) C13 + (4) QuadLock	11.5 kW	11.5 kW	1U
<b>220 - 240/380 - 415 Volt, Three-Phase Input</b>								
EA-6282-C	EA-6282-E	EA-6282-CE	16A	IEC 60309 16 3P+N+E	(12) C13	11.5 kW	11.5 kW	1U
EA-6288-C	EA-6288-E	EA-6288-CE	16A	IEC 60309 16 3P+N+E	(9) C19	11.5 kW	11.5 kW	1U
EA-6299-C	EA-6299-E	EA-6299-CE	16A	IEC 60309 16 3P+N+E	(8) C13 + (4) C19	11.5 kW	11.5 kW	1U
EA-6299W-C	EA-6299W-E	EA-6299W-CE	16A	IEC 60309 16 3P+N+E	(8) C13 + (4) QuadLock	11.5 kW	11.5 kW	1U

Notes: \*\*Redundancy Pack includes 2 PDUs in Black and Glacier White for easy identification of the primary and secondary unit.

## ORDERING INFORMATION

Switched Pro eConnect PDU, Horizontal - North America							
Part Number			Input Amperage	Input Plug	Outlets	kW Capacity (UL)	Form Factor (U) Height
Black	Glacier White	Redundancy Pack**					
<b>120 Volt, Single-Phase Input</b>							
EA-6401-C	EA-6401-E	EA-6401-CE	20A	NEMA L5-20P	(24) 5-20	1.9 kW	2U
EA-6402-C	EA-6402-E	EA-6402-CE	30A	NEMA L5-30P	(24) 5-20	2.9 kW	2U
<b>208 Volt, Single-Phase Input</b>							
EA-6470-C	EA-6470-E	EA-6470-CE	20A	NEMA L6-20P	(24) C13	3.3 kW	2U
EA-6469-C	EA-6469-E	EA-6469-CE	20A	NEMA L6-20P	(18) C13 + (6) C19	3.3 kW	2U
EA-64G0W-C	EA-64G0W-E	EA-64G0W-CE	20A	NEMA L6-20P	(6) C13 + (12) QuadLock	3.3kW	2U
EA-6404-C	EA-6404-E	EA-6404-CE	30A	NEMA L6-30P	(24) C13	5 kW	2U
EA-6412-C	EA-6412-E	EA-6412-CE	30A	NEMA L6-30P	(18) C13 + (6) C19	5 kW	2U
EA-64A1-C	EA-64A1-E	EA-64A1-CE	30A	NEMA L6-30P	(6) C13 + (12) C19	5 kW	2U
EA-64A1W-C	EA-64A1W-E	EA-64A1W-CE	30A	NEMA L6-30P	(6) C13 + (12) QuadLock	5 kW	2U
<b>120/208 Volt, Single-Phase Input</b>							
EA-64G2W-C	EA-64G2W-E	EA-64G2W-CE	30A	NEMA L14-30P	(6) C13 + (12) QuadLock	5 kW	2U
EA-6492-C	EA-6492-E	EA-6492-CE	30A	NEMA L14-30P	(12) C13 + (6) C19 + (4) 5-20	5 kW	2U
<b>120/208 Volt, Three-Phase Input</b>							
EA-6406-C	EA-6406-E	EA-6406-CE	20A	NEMA L21-20P	(24) C13	5.7 kW	2U
EA-6414-C	EA-6414-E	EA-6414-CE	20A	NEMA L21-20P	(18) C13 + (6) C19	5.7 kW	2U
EA-64A3-C	EA-64A3-E	EA-64A3-CE	20A	NEMA L21-20P	(6) C13 + (12) C19	5.7 kW	2U
EA-6490-C	EA-6490-E	EA-6490-CE	20A	NEMA L21-20P	(12) C13 + (6) C19 + (4) 5-20	5.7 kW	2U
EA-64A3W-C	EA-64A3W-E	EA-64A3W-CE	20A	NEMA L21-20P	(6) C13 + (12) QuadLock	5.7 kW	2U
EA-6407-C	EA-6407-E	EA-6407-CE	30A	NEMA L21-30P	(24) C13	8.6 kW	2U
EA-6415-C	EA-6415-E	EA-6415-CE	30A	NEMA L21-30P	(18) C13 + (6) C19	8.6 kW	2U
EA-64A5-C	EA-64A5-E	EA-64A5-CE	30A	NEMA L21-30P	(6) C13 + (12) C19	8.6 kW	2U
EA-6491-C	EA-6491-E	EA-6491-CE	30A	NEMA L21-30P	(12) C13 + (6) C19 + (4) 5-20	8.6 kW	2U
EA-64A5W-C	EA-64A5W-E	EA-64A5W-CE	30A	NEMA L21-30P	(6) C13+ (12) QuadLock	8.6 kW	2U
<b>208 Volt, Three-Phase Input</b>							
EA-6405-C	EA-6405-E	EA-6405-CE	30A	NEMA L15-30P	(24) C13	8.6 kW	2U
EA-6413-C	EA-6413-E	EA-6413-CE	30A	NEMA L15-30P	(18) C13 + (6) C19	8.6 kW	2U
EA-64A6-C	EA-64A6-E	EA-64A6-CE	30A	NEMA L15-30P	(6) C13 + (12) C19	8.6 kW	2U
EA-64A6W-C	EA-64A6W-E	EA-64A6W-CE	30A	NEMA L15-30P	(6) C13 + (12) QuadLock	8.6 kW	2U
EA-64A7-C	EA-64A7-E	EA-64A7-CE	50A	CS8365	(6) C13 + (12) C19	14.4 kW	2U
EA-64G3W-C	EA-64G3W-E	EA-64G3W-CE	50A	CS8365	(6) C13 + (12) QuadLock	14.4 kW	2U
EA-64A8-C	EA-64A8-E	EA-64A8-CE	60A	IEC 60309 60A 3P+E	(6) C 13 + (12) C19	17.2 kW	2U
EA-64A8W-C	EA-64A8W-E	EA-64A8W-CE	60A	IEC 60309 60A 3P+E	(6) C13 + (12) QuadLock	17.2 kW	2U

Notes: \*\*Redundancy Pack includes 2 PDUs in Black and Glacier White for easy identification of the primary and secondary unit.





ORDERING INFORMATION

Switched Pro eConnect PDU, Horizontal - Worldwide								
Part Number			Input Amperage	Input Plug	Outlets	kW Capacity Worldwide (CE)	kW Capacity North America (UL)	Form Factor (U) Height
Black	Glacier White	Redundancy Pack**						
<b>220 - 240 Volt, Single-Phase Input</b>								
EA-6408-C	EA-6408-E	EA-6408-CE	16A	C20 Inlet to IEC 60309 16A 1P+N+E	(24) C13	3.8 kW	3.8 kW	2U
EA-6419-C	EA-6419-E	EA-6419-CE	16A	C20 Inlet to IEC 60309 16A 1P+N+E	(18) C13 + (6) C19	3.8 kW	3.8 kW	2U
EA-64G1W-C	EA-64G1W-E	EA-64G1W-CE	16A	C20 inlet to IEC 60309 16A 1P+N+E	(6) C13+ (12) QuadLock	3.8kW	3.8 kW	2U
EA-6409-C	EA-6409-E	EA-6409-CE	32A	IEC 60309 32A 1P+N+E	(24) C13	7.7 kW	6.1 kW	2U
EA-6420-C	EA-6420-E	EA-6420-CE	32A	IEC 60309 32A 1P+N+E	(18) C13 + (6) C19	7.7 kW	6.1 kW	2U
EA-64A2-C	EA-64A2-E	EA-64A2-CE	32A	IEC 60309 32A 1P+N+E	(6) C13 + (12) C19	7.7 kW	6.1 kW	2U
EA-64A2W-C	EA-64A2W-E	EA-64A2W-CE	32A	IEC 60309 32A 1P+N+E	(6) C13+ (12) QuadLock	7.7 kW	6.1 kW	2U
<b>220 - 240/380 - 415 Volt, Three-Phase Input</b>								
EA-6410-C	EA-6410-E	EA-6410-CE	16A	IEC 60309 16A 3P+N+E	(24) C13	11.5 kW	11.5 kW	2U
EA-6421-C	EA-6421-E	EA-6421-CE	16A	IEC 60309 16A 3P+N+E	(18) C13 + (6) C19	11.5 kW	11.5 kW	2U
EA-64A4-C	EA-64A4-E	EA-64A4-CE	16A	IEC 60309 16A 3P+N+E	(6) C13 + (12) C19	11.5 kW	11.5 kW	2U
EA-64A4W-C	EA-64A4W-E	EA-64A4W-CE	16A	IEC 60309 16A 3P+N+E	(6) C13+ (12) QuadLock	11.5 kW	11.5 kW	2U
EA-64A9-C	EA-64A9-E	EA-64A9-CE	32A	IEC 60309 32A 3P+N+E	(6) C13 + (12) C19	23.0 kW	18.4 kW	2U
EA-64A9W-C	EA-64A9W-E	EA-64A9W-CE	32A	IEC 60309 32A 3P+N+E	(6) C13+ (12) QuadLock	23.0 kW	18.4 kW	2U

Notes: \*\*Redundancy Pack includes 2 PDUs in Black and Glacier White for easy identification of the primary and secondary unit.



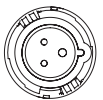
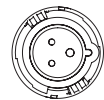
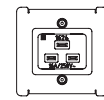

PLUG/INLET TABLE

Single-Phase



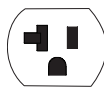

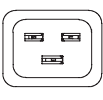



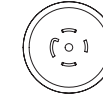

 NEMA L5-20P 110-125 VAC/20A	 NEMA L5-30P 110-125 VAC/30A	 NEMA L6-20P 200-240 VAC/20A	 NEMA L6-30P 200-240 VAC/30A	 NEMA L14-30P 120/208V/30A
 IEC 16A 1P+N+E 200-240VAC/16A	 IEC 32A 1P+N+E 200-240VAC/32A	 IEC C20 200-240VAC/20A		

POWER RECEPTACLE/OUTLET TABLE

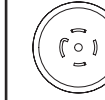
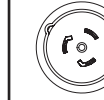
Receptacles/Outlets

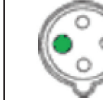
 NEMA 5-20R 120 VAC/20A	 IEC C13/C15 100-240V/10A	 IEC C19 100-240V/16A
 Quadlock (C13/ C15/C19/C21) 100-240VAC/16A		

Three-Phase

 NEMA L15-20P 208 VAC/20A	 NEMA L15-30P 208 VAC/30A	 NEMA L21-20P 120/208 VAC/20A	 NEMA L21-30P 120/208 VAC/30A	 NEMA L22-20P 240/415 VAC, 20A	 NEMA L22-30P 380/415 VAC/30A	 50A CS8365 208 VAC/50A	 IEC 60A 3P+E 208V/60A	 IEC 100A 3P+E 208V/100A
 IEC 16A 3P+N+E 240/415VAC/16A	 IEC 32A 3P+N+E 240/415VAC/32A	 IEC 60A 3P+N+E 240/415VAC/60A	 IEC 100A 3P+N+E 240/415VAC/100A					



**Extended Limited Warranties**

Extended Limited Warranties on CPI-Branded Electronic products, available for two additional years beyond the expiration of the Original Warranty Period (3 years).

Contact CPI Customer Service, or visit [chatsworth.com/warranty](http://chatsworth.com/warranty) for more information.

**POWER MANAGEMENT, ENVIRONMENTAL MONITORING AND PHYSICAL SECURITY INTEGRATION**



**eConnect® RFID Electronic Lock Kit**

Integrate cabinet access control along with power management and environmental monitoring under a single network connection, one user interface and one user database for dramatically reduced deployment savings. Fully compatible with DCIM software. Available on vertical Monitored, Monitored Pro, Switched and Switched Pro eConnect PDUs that have Field-Replaceable Controller Modules with AUX ports.



**Power IQ® (PIQ) for eConnect**

Power IQ® is a data center energy, power, environmental and access control monitoring software that provides out-of-the-box support for eConnect PDUs, Networked Control Module as well as devices from many other manufacturers.



**USB Temperature and Humidity Sensor**

Attaches to the USB port in the PDUs.



14676-001

**Field-Replaceable Controller Module**

Field-replaceable controller module for eConnect® Power Distribution Unit (PDU). Compatible with eConnect Monitored, Monitored Pro, Switched or Switched Pro eConnect PDUs. Allows replacement of controller module while maintaining power to critical loads. Ability to use an SD-card to transfer PDU configuration. Available in two options, to match to either a Vertical or Horizontal eConnect PDU form factor. Both controller modules include connections for ethernet, Secure Array IP Consolidation, temperature and humidity sensors, RFID Electronic Locks and serial/console interface. Controller module for Vertical eConnect PDUs also includes a local display.



14812-001

[chatsworth.com](http://chatsworth.com)  
[techsupport@chatsworth.com](mailto:techsupport@chatsworth.com)  
 800-834-4969

Part Number	Description
L1-2YEXTWAR-ELECTRONICS-C	2-Year Warranty Extension for PDUs with MSRP up to \$1700
L2-2YEXTWAR-ELECTRONICS-C	2-Year Warranty Extension for PDUs with MSRP \$1701 - \$3400
L3-2YEXTWAR-ELECTRONICS-C	2-Year Warranty Extension for PDUs with MSRP > \$3400

Part Number	Description	Shipping Weight lb (kg)
14666-001	eConnect® RFID Electronic Lock Kit For ZetaFrame Cabinets	3 (1.4)

*Note: Order your ZetaFrame cabinet with eConnect PDUs and RFID Electronic Lock Kit preinstalled.*

Power IQ for eConnect Software and License, With 1-Year Maintenance Plan			
Part Number	Number of Licenses	Part Number	Number of Licenses
36603-001	Up to 10 Devices	36603-020	Up to 200 Devices
36603-002	Up to 20 Devices	36603-030	Up to 300 Devices
36603-005	Up to 50 Devices	36603-040	Up to 400 Devices
36603-010	Up to 100 Devices	36603-050	Up to 500 Devices

Additional Accessories		
Part Number	Description	Shipping Weight lb (kg)
14665-001	USB Temperature and Humidity Sensor	3 (1.4)

Part Number	Description	Shipping Weight lb (kg)
14676-001	eConnect Controller 4 (MCM4) for Vertical eConnect PDUs	1 (0.5)
14812-001	eConnect Controller 4H (MCM4) for Horizontal eConnect PDUs	1 (0.5)

*Note: Compatible with PDU P/Ns: EA-3xxx, EA-4xxx, EA-5xxx, EA-6xxx.*



**Simplify ordering, shipping and installation by requesting eConnect PDUs and RFID Electronic Lock Kit to be installed in CPI's ZetaFrame® Cabinets before they leave the factory. Request Redundancy Pack for easy identification of primary and secondary units.**

While every effort has been made to ensure the accuracy of all information, CPI does not accept liability for any errors or omissions and reserves the right to change information and descriptions of listed services and products.

©2025 Chatsworth Products, Inc. All rights reserved. Chatsworth Products, Clik-Nut, CPI, CPI Passive Cooling, CUBE-T, Secure Array, eConnect, Evolution, GlobalFrame, MegaFrame, QuadraRack, RMR, Saf-T-Grip, SeismicFrame, SlimFrame, TeraFrame, Motive, EuroFrame, Oberon, Velocity and ZetaFrame are federally registered trademarks of Chatsworth Products. H-Plane, Hi-Bar, In-Plane, M-Frame, NetPoint, Simply Efficient, Skybar, and Wi-Tile and are trademarks of Chatsworth Products. All other trademarks belong to their respective companies. Rev8 07/25 MKT-60020-723