







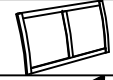

ASSEMBLY INSTRUCTIONS

B0182-315 BALLARD 5/0 Q HEADBOARD , FOOTBOARD & SLAT KIT







B0182-335 BALLARD 6/6 & 5/0 EK/Q PANEL SIDE RAILS

Thank you for purchasing this quality product. Be sure to check all packing materials carefully for small parts, which may have come loose inside the carton during shipment. Identify and count all items and compare with the parts list and/or hardware list shown.

PARTS LIST

NO	COMPONENT	DRAWING	QTY
A	Headboard		1 pc
B	Footboard		1 pc
C	Right Side Facing (RSF) Headboard Leg		1 pc
D	Left Side Facing (LSF) Headboard Leg		1 pc
E	Slat		4 pcs
F	Slat Support Leg		4 pcs
G	Rail		2 pcs
H	Headboard Stretcher		1 pc

HARDWARE LIST

PACKED INSIDE HEADBOARD			
NO	COMPONENT	DRAWING	QTY
1	Bolt M6 x 1 3/8"		6 pcs
2	Spring Washer 1/4"		6 pcs
3	Flat Washer 1/4" ID x 1/2" OD		6 pcs
4	Allen Key M4 x 2 9/16"		1 pc
5	Allen Key M5 x 2 9/16"		1 pc
6	Flat Head Screw M4 x 1 1/4"		8 pcs

WEIGHT CAPACITY

800 LBS

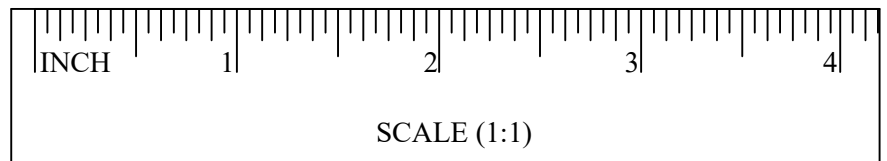

STEP 1 : Assemble the Headboard Legs (C & D) to the Headboard (A) by using the Allen Key (4) with hardware 1, 2, and 3.

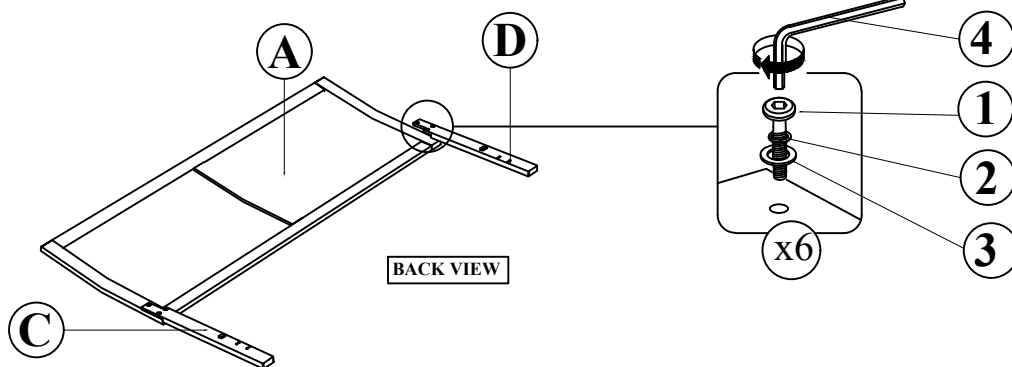

STEP 2 : Assemble the Headboard Stretcher (H) to Headboard Legs (C & D) by using a screwdriver with hardware (6).

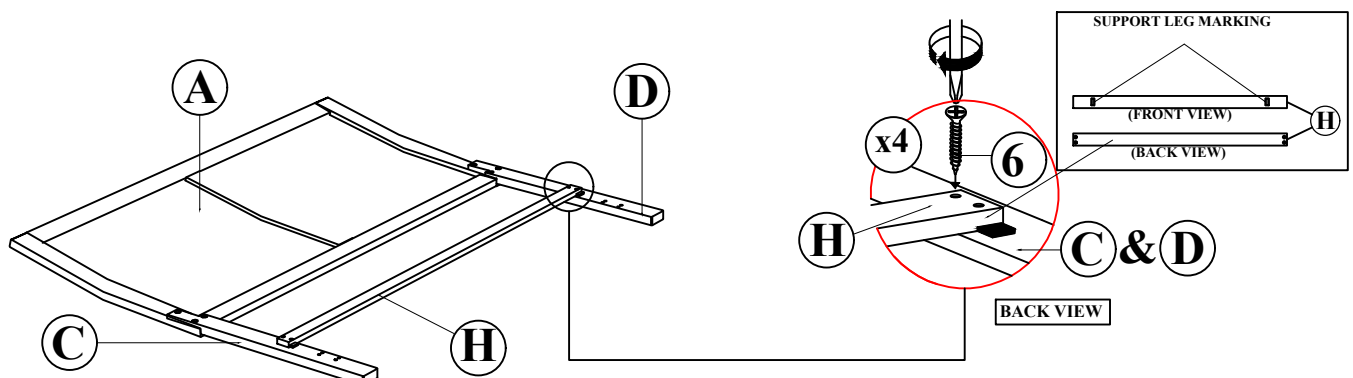

STEP 3 : Loosen the bolts on the Headboard Legs (C & D) and the Footboard (B) by using ALLEN KEY (5). Hook the Capped Rails(G) to the Headboard Legs (C & D) and the Footboard (B), and push the bracket firmly into place then tighten the bolts.

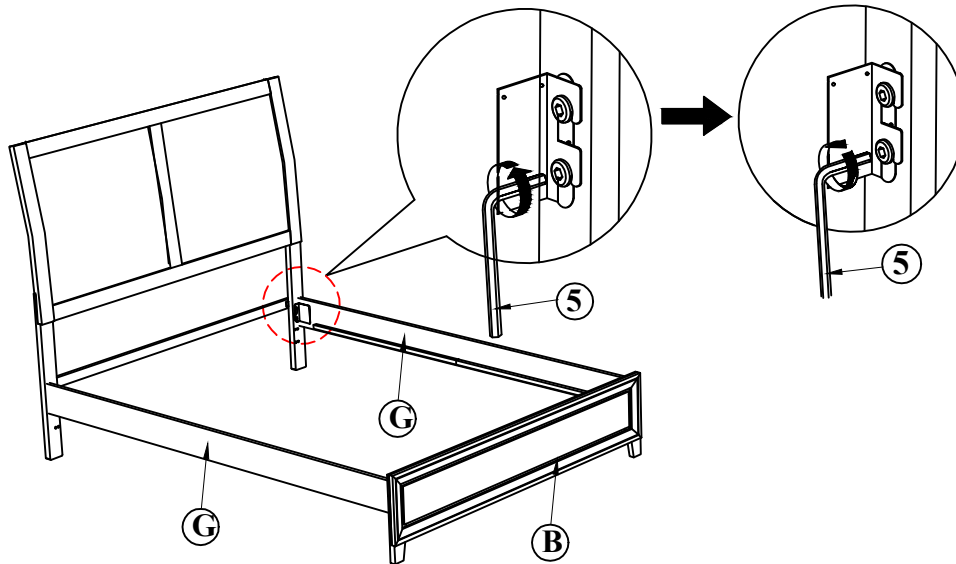

STEP 4 : Assemble the Bed Slat Support Legs (F) to the Slats (E)

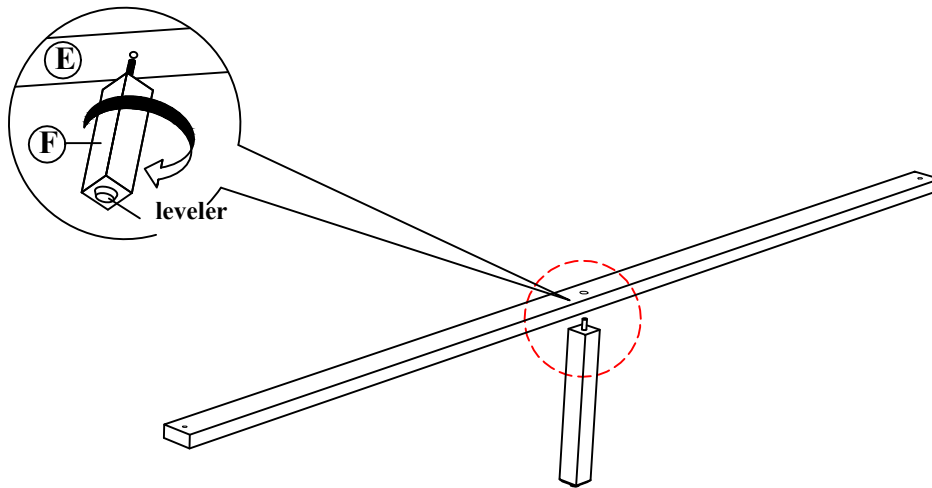

STEP 5 : Assemble the Slats (E) to Capped Rails (G) by using a screwdriver with hardware 6. Adjust the leveler on the Bed Slat Support Legs (F) to level the bed.

